

Voices of Teachers and Teacher Educators



Volume X Issue I July, 2021 ISSN 2455-1376

Voices of Teachers and Teacher Educators

Volume X

Issue I

July, 2021

Published by:

National Council of Educational Research and Training (NCERT) on behalf of Ministry of Education, Government of India, New Delhi.

Preparation of the publication at NIE (NCERT), New Delhi.

Cover Design & Layout Design: Mr. Girish Goyal

Assistance: Ms. Shalini Choudhary

About the Journal

The journal 'Voices of Teachers and Teacher Educators', an initiative of the Ministry of Human Resource Development (MHRD) (at present Ministry of Education) is being co-ordinated by the NCERT. The Journal highlights the vital role of teacher education in India, as the country is poised to provide quality education to all its children, irrespective of gender, caste, creed, religion and geography. The National Curriculum Framework (NCF)-2005, the National Curriculum Framework for Teacher Education (NCFTE)-2009 and the Right of Children to Free and Compulsory Education Act (RTE)-2009 and also the National Education Policy, 2020 all reflect this commitment and underline the principles that make such an effort necessary and also spell out the strategies for it. The challenge is to augment the role of teachers in shaping the social transformation that India is witnessing, have a long lasting impact on the quality of education, and making education equitable. Teachers and all those concerned with education need to recognize that their ownership and voices are important and that they can and do learn not only from their own experiences but also from each other through collective reflection and analysis. The Journal attempts to lend voice to teachers, teacher educators, researchers, administrators and policy makers in varied institutions such as schools, Cluster Resource Centres (CRCs), Block Resource Centres (BRCs), District Institutes of Education and Training (DIETs), Institutes of Advanced Studies in Education (IASEs), Colleges of Teacher Education (CTEs), State Councils of Educational Research and Training (SCERTs), etc., and make their engagement visible in accomplishing extraordinarily complex and diverse tasks that they are expected to perform. Contributions to the Journal are welcome both in English and Hindi. Voices is an e-Journal and we hope to circulate it widely. We also look forward to suggestions and comments on the articles published. The views expressed and the information given are that of the authors and may not reflect the views of the NCERT.

Call for Contributions

This biannual publication is for all of us: teachers, teacher educators, administrators, researchers and policy makers. It seeks to provide a platform and build a network for our voices, ideas and reflections. To enable this journal to reflect all voices, we must contribute to it in as many ways as we can. We look forward to many contributing with different experiences, questions, suggestions, perspectives as well as critical comments on different aspects of teacher education and schooling. The contributions could be in the form of articles, reports, documents, pictures, cartoons or any other forms of presentation amenable for print. We also seek comments and reflections on the current issue to improve publication and make it a participative endeavour. We must together make this journal truly reflective of our voices. We look forward to receive your contributions for the next issue by 30th October, 2021. We also look forward to your comments and suggestions. The contributions can be sent to the following:

E-mail: voicesofeducators2016@gmail.com

Advisory Board

Hrushikesh Senapaty
M.A. Khader
Ashok K. Srivastava
Amarendra Behera

Editorial Team

Hriday Kant Dewan
B.P. Bhardwaj
Ranjana Arora (Convener)
K.V. Sridevi

Associate Editors for the Issue:

Vijayan K.
Aerum Khan

Contributors

Yatika Arya, PhD Research Scholar, Department of Human Development, Childhood Studies, Lady Irwin College, **Priti Joshi**, Associate Professor, Department of Human Development; Childhood Studies, Lady Irwin College

Neelima Khetan, Chandragupta Institute of Management, **Hriday Kant Dewan**, Azim Premji University

Manasi Thapliyal Navani and **Shivani Nag**, Assistant Professor School of Education Studies, AUD Lodhi Road Campus Aliganj, BK Dutt Colony, Lodhi Road New Delhi 110003

Sneh Bansal, Principal Chandigarh College of Education, Punjab, India **Harpreet Kaur**, Principal Sri Guru Harkrishan Model School, Chandigarh, India

Prakash Bhue, Doctoral Student, Department of Sociology Sambalpur University, Jyoti Vihar-768019, Odisha; India, **Tattwamasi Paltasingh**, Professor, Head, Department of Sociology, Sambalpur University Jyoti Vihar-768019, Odisha; India

Meenal Arora, Research Scholar, Department of Teacher Training and Non-Formal Education (IASE), Faculty of Education, Jamia Millia Islamia, Delhi, **Jasim Ahmad**, Professor, Department of Teacher Training and Non-Formal Education (IASE), Faculty of Education, Jamia Millia Islamia, Delhi.

Pankaj Das, Assistant Professor, School of Education, Sharda University, Greater Noida, Uttar Pradesh.

Rahul Mukhopadhyay, Visiting Faculty, Azim Premji University, School of Education, Survey No 66, Burugunte Village, Bikkanahalli Main Road, Sarjapura, Bengaluru 562125, **Archana Mehendale**, Adjunct Honorary Professor, Centre for Excellence in Teacher Education (CETE), Tata Institute of Social Sciences, V.N. Purav Marg, Deonar, Mumbai 400088

Prateek Chaurasia, Assistant Professor Department of Education Mizoram University, Aizawl, Mizoram-796004

- 
- Afshan Naz Quazi**, Assistant Professor (Former), Department of Education, Regional Institute of Education, (NCERT), Pushkar Road, Ajmer, Rajasthan, India -305004.
- Amitosh Dubey**, Producer (senior scale), Electronic Media Production Centre IGNOU, New Delhi 110068
- R. Suryakala**, Assistant Professor of Education, Annammal College of Education for Women, Thoothukudi, Tamil Nadu
- Savita Ladage, Hanza George, Sugra Chunawala**, Homi Bhabha Centre for Science Education, Tata Institute of Fundamental Research, V.N. Purav Marg, Mankhurd, Mumbai 88 INDIA
- Nidhi Gulati**, Assistant Professor, Department of Elementary Education, Institute of Home Economics, University of Delhi
- Denny John. K.**, Research Scholar, Department of Education, Gandhigram Rural Institute Deemed to be university, Dindigul, **P. S. Sreedevi**, Assistant Professor, Department of Education, Gandhigram Rural Institute Deemed to be university, Dindigul.
- Parul Kalra**, Visiting faculty at Tata Institute of Social Sciences, Mumbai.
- Pooja Singal**, Assistant Professor in the Department of Elementary Education, Lady Shri Ram College for Women, University of Delhi.
- Shruti Chopra**, Assistant Professor (Science Education), Lady Shri Ram College for Women, University of Delhi, **Abhishreya Sasan**, Student, Bachelors of elementary education , Lady Shri Ram College for Women
- Pragya Gupta**, Assistant, Professor, Department of Teacher Education, Central University of South Bihar, Gaya-824236, India.
- Anirban Roy Doctoral Scholar, Sushmita Singh**, Department of Life Sciences, Department of Education in Science and Mathematics Regional Institute of Education (NCERT) Bhubaneswar- 751022, Odisha
- Astha Singh**, Junior Research Fellow, Department of Education, University of Lucknow, Lucknow, U.P., **Amita Bajpai**, Former Head and Dean, Department of Education, University of Lucknow, Lucknow, U.P.

Reviewers List

S. No.	Reviewers	Email Id.	Address
1	Aerum Khan	akhan26@jmi.ac.in	Assistant Professor, Department of TT & NFE (IASE), Faculty of Education, Jamia Millia Islamia, New Delhi
2	Disha Nawani	dishanawani@yahoo.com	Professor, Tata Institute of Social Sciences, Mumbai
3	Gurumurthy Kasinathan	Guru@itforchange.net	Director, IT for Change, Bengaluru 560041
4	H.K. Dewan	hardy@azimpremjifoundation.org	Professor, Azimpremji University Bangalore
5	Haneet Gandhi	haneetgandhi@gmail.com	Associate Professor, CIE, Delhi University
6	K. V. Sridevi	kvsridevi@gmail.com	Assistant Professor, DCS, NCERT
7	K. Vijayan	kanothvijayan@rediffmail.com	Assistant Professor, DTE, NCERT
8	M.V. Srinivasan	vadivel.srinivasan@gmail.com	Associate Professor, DESS
9	Raghavachari Amritavalli	amritavalli@gmail.com	Formerly Professor, Linguistics The English and Foreign Languages University Hyderabad 500 007, India
10	R. Rajashree	rajashree@azimpremjifoundation.org	Associate Professor, Azimpremji University Bangalore
11	Rajni Dwivedi	ritudwi@gmail.com	Educator, Tejpur Assam
12	Ranjana Arora	ranjuarora1967@yahoo.co.in	Professor and Head, Department of Teacher Education, NCERT
13	Rekha Pappu	rekhapappu@yahoo.com	Associate Professor, Tata Institute of Social Sciences, Hyderabad Campus
14	Rekha Sen Sharma	rekha_s_sen@hotmail.com	Professor, School of Continuing Education, IGNOU, New Delhi.
15	Seema Ojha	Seema.ojha@gmail.com	Professor, DESS, NCERT
16	Shivani Nag	shivani@aud.ac.in	Associate Professor, Ambedkar University
17	Nidhi Gulati	nidhi.a.gulati@gmail.com	The Institute of Home Economics, University of Delhi
18	Jasim Ahmed	jahmad@jmi.ac.in	Associate Professor, Institute of Advanced Studies in Education (IASE), Hony. Dy. Director, DIC, CIE Sr. Warden, Kellat Hostel, Nodal Officer, IQAC, Jamia Millia Islamia
19	Jessy Abraham	jabraham@jmi.ac.in	Prof. Jessy Abraham IASE, Faculty of Education Jamia Millia Islamia
20	Savita Kaushal	skaushal@jmi.ac.in	Jamia Millia Islamia
21	Nimrat Kaur	nimrat.kaur@azimpremjifoundation.org	Professor, Azimpremji University
22	Gurjeet Kaur	gurjeet_edu@yahoo.co.in	Jamia Millia Islamia, New Delhi



23	Dr. Rejaul Karim Barbhuiya	rejaul.jmi@gmail.com	Assistant Professor (Computer Science), Central Institute of Educational Technology (CIET), NCERT (An Autonomous Body Under MHRD, GOI)
24	Richa Goswami	goswami84@gmail.com	Mumbai

Contents

1. Literacy Development in the Foundational Years of School: Teachers' Experiences <i>Yatika Arya and Priti Joshi</i>	1-9
2. Re-emphasising the Physical School: Lessons from COVID-19 <i>Neelima Khetan and Hriday Kant Dewan</i>	10-15
3. The emergent transition to remote learning online: A study of postgraduate education students' experiences <i>Manasi Thapliyal Navani and Shivani Nag</i>	16-29
4. Perception of Inclusive School and Perceived preparedness and Concerns among school Principals in Chandigarh, India <i>Dr. Sneh Bansal and Harpreet Kaur,</i>	30-45
5. Child-centered Education in Indian Schools: Policies and the Practice <i>Dr. Tattwamasi Paltasingh and Prakash Bhue</i>	46-53
6. Green School Model: Best Practices From The Field On Education For Sustainability In India <i>Meenal Arora and Prof. (Dr.) Jasim Ahmad</i>	54-62
7. Critical Pedagogy and Issue of Social Liberation: A Policy Perspective <i>Dr. Pankaj Das</i>	63-69
8. Policy Shifts in School Education <i>Rahul Mukhopadhyay and Archana Mehendale</i>	70-78
9. Values in Education: An Astounding Wealth of a Nation in the Contemporary World <i>Dr. Afshan Naz Quazi</i>	79-92
10. Investigating Conceptual Changes and Difficulties in Learning Mathematics during the Transitional Phase from Arithmetic to Algebra <i>Dr. Prateek Chaurasia</i>	93-101
11. Research Productivity of Teacher Educators <i>Dr. R. Suryakala</i>	102-110
12. Two Decades (1999-2018) Of Research Studies In Teacher Education Through Open And Distance Learning <i>Dr. Amitosh Dubey</i>	111-119
13. "Reflections on the Cascade Model for Teacher Professional Development: A Case Study of RSC-Yusuf Hamied Inspirational Chemistry Programme in India <i>Prof. Savita Ladage, Hanza George and Sugra Chunawala</i>	120-135
14. Righting wrongs: A Handbook of Child Rights for Teachers : <i>Monisha Bajaj, 2016 , Chennai: Tullika Nidhi Gulati</i>	136-140
15. Effect Of Social Media Enabled Learning In Enhancing Achievement In Physics At Higher Secondary Level <i>Mr. Denny John. K, Dr. P.S. Sreedevi</i>	141-145



16. Life History Method to Study Policy Changes and it's impact on teacher's lives: Experiences, Dilemmas and Reflections <i>Parul Kalra</i>	146-151
17. A Peep inside an Online Pre-Primary Classroom during COVID-19 Times: Some Reflections <i>Pooja Singal</i>	152-156
18. Stories as a Pedagogical Tool for Teaching-Learning of Basic Astronomy <i>Shruti Chopra and Abhishreya Sasan</i>	157-167
19. Perception of Prospective Teachers towards Four Year Integrated Teacher Education Programme <i>Dr. Pragya Gupta</i>	168-176
20. Investigating The Learning Gaps Of Senior-Secondary Children Through Original (Real-Life) Biological Images: What Really Lacks? <i>Anirban Roy (Doctoral Scholar (JRF)) and Sushmita Singh</i>	177-190
21. Visualizing Inclusive School <i>Astha Singh and Amita Bajpai</i>	191-196

Editorial

These are difficult times and in these difficult times children and education are silent sufferers. The immediate priorities have been demanding so much attention that these have again got to the back burner. We have more to wait before we can pay these the attention they have required in the past. Indeed with the fact that children have not been able to access any school or education for over a year getting them back to the rhythm of the school and the rigours of learning is not going to automatic. Those who were near the level of independent reading and those who were struggling and reading a few words would have slipped for the lack of opportunity to build on what they knew and the absence of peer and teacher guidance. For those who had developed capability of reading or doing some tasks in mathematics would have to recapture the abilities and that would require patience from all of us. There has been absence of school for a long while for most children and even for those who have had on line classes there has not been as much engagement and learning. Many studies with the teachers, parents and children have shown that they all feel that schools are being missed and would hope that they open as fast as they can. What we all wish is that it should happen soon and we make up for the lost time and here we need to be cautious. In our activity as well as in work with children we have to keep in mind that we move slowly. The school should not try to quickly take the learners to the age expected levels and burden them with texts and tasks that they may have found easy to do when they were having regular schools. There is a need to be patient as there is in the return to the kind of movement and social mixing that we were used to.

The New Education Policy 2020 has presented many ideas that have been a continued thread in Indian educational thought. These ideas about the need to encourage self-learning and building the initial or foundational capabilities to the extent that they become a part of the natural repertoire of the learner enabling him to move forward and become a self-directed learner having the ability to also acquire sources from sources other than the classroom as well. The policy emphasises the foundational literacy and also the foundational mathematical and numeracy abilities and give indicators of what they include.

The report of the committee (Dr. K. Kasturirangan Committee Report) that is supplementary to the briefer National Education Policy 2020 document elaborates how the development of learning should be seen across different stages and not merely across grades. It also points out the need for a holistic view of learning and focus on the enablement of learners towards an anxiety free and wholesome learning. It emphasises not just the Foundational literacy and basic mathematical development but also the development of a person that is emotional and socially ethical following the Constitutional directed and human values among which are included values of justice, equity, liberty, plurality and Fraternity. Needless to say for these schools and conversations among children from different background in a free, open and equal way are essential. The purpose of the school therefore as and when they open has to be looked at with inclusion of all these ideas and the effort to carry all learners in the classroom process of teaching and learning.

It is important to talk about and think about this as we prepare for ways to engage with children and struggle to provide them with some occasions to engage with these broad aspects of the school as well and look at their learning trajectory in language and mathematics also holistically and not in a piecemeal manner. We have the next issue focus on the way forward from the NEP 2020 and there would be perhaps many ideas that we would see that would help us in this journey as well. We hope many more people would write for the next issue.



And now about this issue, which has been delayed due to the difficulties in having review, copy editing and design and finalisation of the issue during lock down but we are once again grateful to the reviewers who have helped us give feed back to the authors and help us identify papers suitable for the purposes of this publication. The focus of this is to enable teachers and teacher educators to write their reflective experiences in a form that is located in the academic discourse and also provide a platform to young researchers working in school and teacher education to present their researches that have some implications for school and teacher education and for the teachers and teacher educators.

We look forward to more papers in these domains in the future as well. This issue I, VOL-X, JULY-2021 has 21 papers and articles including a book review. The largest share, in all 7, of these expectedly are focused on matters related to the Teachers. These include their recruitment, their preparation, professional development and continued education and on their experiences, reflections and perceptions. Two papers are linked to the recent efforts of online teaching in the times of the lock down due to COVID pandemic. Two papers are around secondary education and two deal with early learning and two on inclusive schools. There is therefore a wide variety of issues in school and teacher education and allied issues that has been covered in this issue.

The first article by Yatika Arya and Priti Joshi is titled “Literacy Development in Foundational Years of School: Teachers’ Experiences’. The paper points out the social and cultural embeddedness of Literacy skills and its slow development over a long period of time. The authors point out that research has shown many interesting aspects of this process including that it develops best in a responsive setting. The authors have worked with teachers of some schools of Delhi and documented their practices and interviewed them to seek their experiences and understandings. They conclude that the teachers find it difficult to create occasions and opportunities for exploration and self-expression in early years of schooling because of variety of reasons including a lack of materials. They recommend emphasis of these areas in teacher development programs as the inclination of effort towards these in classrooms is reducing.

The second article by Neelima Khetan and Hriday Kant argues that the recent closure of schools and the attempts to include children in on-line sessions brings to fore the necessity of physical schools and the limitations of the virtual mode. The paper refers to different studies as well as its own data of phone interviews with children to conclude that not just children (who have necessary device and bandwidth to access online classes) and their parents (who are comparatively aloof or those deeply engaged with their learning interactions) are extremely disappointed by the online classes but the teachers also find them extremely inadequate. The paper argues for the need to look for ways of making interactions among children feasible through locally conceptualised mechanisms as early as possible.

The third paper emergent transition to remote learning online: A study of experience of students’ doing post-graduation in education by Manasi Thapliyal Navani and Shivani Nag is based on conversations with the students as well as their own observations of the online teaching during the pandemic. This paper attempts to examine and situate the experience of students enrolled in two postgraduate programmes in the discipline of education. The paper reports interesting testimonies from students about the online classes and the difficulties in adjusting to them. The authors suggest that a lot of thinking would have to be put into understanding how to use online classes as a part of blended design and that in the case of education special attention would have to be paid to the development of the human element.

The fourth paper is by Dr. Sneh Bansal, Harpreet Kaur and has the title Perception of Inclusive School and Perceived preparedness and Concerns among school Principals in

Chandigarh, India. The paper is focused on the attempt to identify the challenges perceived by the Principals of the schools to make inclusion possible and understand the state of the infrastructure available for it. The school principals and school observations were the source of data. The data obtained was analyzed under four themes: understanding of the concept of inclusion and principal's contribution in making school inclusive for all, Physical and support services in schools, in- service training of the regular teachers in inclusive education and challenges perceived by the principals in the education of disabled children in schools. The results indicated that although principals had a fairly good idea about inclusion, they did not perceive the schools were ready for inclusion of children with disabilities. The study recommends interventions in building capabilities in the staff as well as providing materials to make the schools inclusive.

The fifth paper by Dr. Tattwamasi Palta singh has the title Child-centered Education in Indian Schools: Policies and the Practice and is focused on the barriers to implementing with child-centered education in Indian schools and suggest an effective pedagogical approach for inclusive school education.

The sixth paper by Meenal Arora and Prof. (Dr.) Jasim Ahmad entitled Green School Model: Best Practices from The Field On Education For Sustainability emphasises the importance of a green school in the light of the challenges related to poverty, hunger, inequality, climate change, loss of biodiversity, natural resource depletion resulting in negative consequences on human health and livelihood. Suggesting that schools go Green to help students understand human impact on the planet and how to address the challenges brought out by the wasteful habits. It studies the efforts schools are making in this direction around the themes of energy, water, waste, food, and biodiversity and in that process empowering various stakeholders to embark on the journey towards sustainable development. The study uses both secondary as well as primary data and is exploratory in nature and also highlights the strategies that schools can easily adopt to make themselves green.

The seventh paper by Dr Pankaj Das has the title Critical Pedagogy and Issue of Social Liberation: A Policy Perspective. It looks at the origins of the critical pedagogy its meaning and implications. It presents the way the term is defined in different documents in particular the NCF 2005 and suggests it as the way to transform society to a desirable form. It also presents the implications of critical pedagogy as described in the NCF on the role of teachers and suggests that the main responsibility for translating the recommendations made in the NCF 2005 lies with the teachers and meaning

The next eighth paper Policy Shifts in School Education by Rahul Mukhopadhyay and Archana Mehendale discusses the evolution in the national policy of education starting from the first comprehensive commission report in 1964-66, which paved the way for the first national policy of education. The paper describes the policy statements and the subtle changes in them and the practices on the ground in moving towards the directive principle intention of providing compulsory education to all. It argues that given the nature of the efforts the consistent political will is required to make quality education available to all in a equitable manner.

The ninth paper by Afshan Naz Quazi, Values in Education: An Astounding Wealth of a Nation in the Contemporary World. The paper argues values have to be an essential part of good education which has to be holistic. It contends that good citizens are made through education and humans are not born good or bad. The paper emphasises on ethical principles such as respect, honesty, empathy, equality, solidarity and critical thinking during learning. This would require intellectual depth, self-reflection, rational thinking and these are fundamental to a life of harmony and sustained progress.



The tenth paper in this issue by Dr Prateek Chaurasia is titled Investigating Conceptual Changes and Difficulties in Learning Mathematics during the Transitional Phase from Arithmetic to Algebra. The paper is based on the study of children in class VI and identifies some of the difficulties children face at this stage where they have to generalise and work with equations and letter numbers. The paper can help teachers study and understand where the children are finding bottle-necks to their understanding and based on that find their next steps.

The eleventh paper Research Productivity of Teacher Educators by Dr. R. Suryakala, is focussed on a study of the research productivity of some teacher educators from a district in Tamil Nadu. The paper points out the low research productivity of these Teacher educators and identifies structural factors that are the cause of the low productivity. The paper also points out measures that can improve the research productivity. It suggests that increased research productivity would improve the quality of work of the teacher educator in other areas as well.

The next paper (twelfth) of Amitosh Dubey explores the research studies carried out on programs of teacher education through open and distance learning in the last two decades (1998-2018). The paper considers researches in India and internationally, and points out that journals are giving adequate attention to open and distance system and many papers are being published in this domain. The paper has however, not reviewed the quality of the researches.

The paper by Savita Ladage, serial number 13, is on the in-service capacity development of one particular cascade model of training. Based on researches across the world that emphasise the need for sustained interaction with teachers instead of just one interaction, the author points out some challenges of using this cost effective way of training. The paper re-emphasises the need for capacity development and continuous engagement of not just the teachers but also the trainers.

The article fourteenth is the review by Nidhi Gulati of a hand book on Child rights. The handbook is called, "Righting wrongs: A Handbook of Child Rights for Teachers" and is written by Monisha Bajaj. The hand book is based on extensive interviews with teachers and the reviewer brings out the essential strengths of the book and what areas does it touch upon.

The next paper, fifteenth in the list, titled 'Effect of social media enabled learning in enhancing achievement in physics at higher secondary level', has been contributed by Mr. Denny John. K , Dr.P.S. Sreedevi. It studies the alternative strategy of Social media Enabled Learning (SMEL) in education. The paper suggests that at secondary level and in the teaching of physics the SMEL strategy is a meaningful possibility particularly in the context of the corona like situations.

The sixteenth article, 'Life History Method to Study Policy Changes and its impact on teacher's lives: Experiences, Dilemmas and Reflections" by Parul Kalra is based on the authors work on the study of teachers and describes the methodology used for a historical study. The paper sketches out the complete process of data collection and throws the light on the participant's views i.e., teacher's views on methodology used by the researcher. In the last two sections the paper delineates dilemmas faced by researcher and reflection on methodology and its dimensions which helped the researcher to navigate through teachers' lives to study the educational policy changes.

The next paper by Pooja Singhal has the title 'A Peep inside an Online Pre-Primary Classroom during COVID-19 Times: Some Reflection, is written from the perspective of a parent and is based on the study of the on-line, pre-primary classes of a private school. It points out that in spite of the policy and what is known from the research on how children

learn and the principles accepted in theoretical ideas on educating young minds, what goes on in these classes in the opposite. They also are not aligned to the values of gender equity and inclusion that have been underlined and have come to be accepted. The author points out that the lessons are only about reading aloud with no conversations and discussion on what the children feel or think about the text.

The eighteenth paper by Shruti Chopra and Abhishreya Sasan, titled, 'Stories as a Pedagogical Tool for Teaching-Learning of Basic Astronomy' has also the element of how to use stories in early learning. It focuses on how the intuitive conceptions about the relative movement of the Sun, Earth and Moon and the phenomena of day and night, phases of moon etc can be affected by story-telling. They point out that due to the embeddedness of some of these in culture and the mythical stories heard by them, the children have alternative conceptions that differ significantly from scientifically accepted conceptions and they have little to no understanding of the actual cause and effect relationship involved in the phenomena. The authors suggest that their study shown that designing and enactment of modules to address these preconceptions using story-telling as a pedagogical strategy enabled learners to establish scientifically accepted conceptions

The paper by Pragya Gupta, serial number 19, titled Perception of Prospective Teachers towards Four Year Integrated Teacher Education Programme, is focused on the perceptions of the prospective teachers on the 4 year program. The idea of the 4 year course has gained in importance in the wake of the NEP 2020 as the policy has endorsed quite strongly the 4 year program among other changes concerning teachers. The paper finds that the prospective teachers are favorably inclined to this but suggests that some reforms would be needed to make this effectively possible.

The twentieth paper by Anirban Roy and Sushmita Singh titled "Investigating the Learning Gaps of Senior-Secondary Children through Original (Real-life) Biological Images: What really lacks?" explores the question of the understanding of the Biology students of class XII regarding what they are taught in schools and their ability to relate it to the real life biology. Their work studies the recognition of real life microscopic and macroscopic images of biological entities and events. They point out that these gaps in the understanding accentuate and harden over time. They suggest the need for similar studies in other disciplines and give some suggestions to counter the possibility of such gaps developing.

The last paper Visualising Inclusive school by Ashta Singh and Amita Bajpai is a road map for the important elements that need to be brought in to develop a school as an inclusive one. They point out the infrastructural needs, sitting arrangement, class size, adjustments in curriculum and assessment, individual care and support, assistive technologies for making this possible. They emphasise the fact that the physical and mental wellness of children is the crucial element and that requires trained teachers, special educators and open and flexible teaching methods to make a school inclusive.

We look forward to more papers from you and as we have been pointing out the papers need to be related to school education or teacher development and linked issues about their working environment and their practices. We would like papers that are not merely quantitative data presentations or are attempts to reconfirm prevalent educational ideas and beliefs. It would be nice if the paper has some interesting insights and new dimensions or more vivid details of some aspects of the above mentioned areas emerge from it. As we said the next issue is focused in National Education Policy 2020 and we would welcome more papers on possible ways for it being used effectively or an exploration of the journey leading up to it and what we can learn from the journey as elements to be kept in mind. The time is however short now and we would accept papers that come in by 30th of October, 2021.

Yatika Arya

yatikaarya6@gmail.com

Priti Joshi

pritisjoshi@gmail.com

Literacy Development in the Foundational Years of School: Teachers' Experiences

Abstract

Literacy skills develop over a period of time as young children interact with their environment in a variety of ways including the use of sounds and symbols. Literacy is a culturally valued and socially situated skill set developed in resourceful, responsive learning settings. This paper is an attempt to interpret the socio-cultural conceptualisation and practice of literacy by researching teachers' lived experiences and understanding of literacy development in selected schools of Delhi.

Introduction

Literacy development includes the use of language in different modes for different purposes. It is an ongoing process. A child starts acquiring sounds and words since the time of birth within the socialcultural context. Young children listen new words in their sociolinguistic environment, and use those words in day-to-day conversations to express themselves. Providing a language-rich environment is crucial for literacy development. Spoken, written and printed words, drawings, symbols, gestures, body movement, melodies, digital texts and formats are all means of the sense-making experience to children as they learn to use them in their social settings.

Children use speech as a tool of thinking. They can be observed thinking out loud while solving a problem. For instance, a young child talks about the puzzle pieces and their placement while putting them on the puzzle board. This speech later gets turned into inner speech or a tool for thinking (Vygotsky, 1986). This way language use or literacy fosters thinking and vice-versa. Oral language is considered the foundation of other forms of literacy like reading, writing, drawing and so on (Kumar, 2000). This means that responsive early childhood

settings provide ample opportunities for children's oral language development.

Oracy and literacy in the *National Curriculum Framework, 2005* are conceived as "tools for learning and for developing higher-order communicative skills and critical thinking" (NCERT, 2005, p. 38). The function of language literacy is seen to further abstract thought and knowledge acquisition. At the same time, the ability to have effective interpersonal and intrapersonal communication and articulation of inner thoughts is seen as an expression of literacy. Government policies and documents define literacy on the basis of functional ability of a person aged seven or above to "read and write with understanding in any language" (Ministry of Home Affairs, 2011, p. 80; Ministry of Human Resource and Development, 2020; Ministry of Statistics and Programme Implementation, 2020). The purpose is to fix a minimal benchmark of literacy to gather data on literacy rate in the country. This definition clearly has not considered young children below the age of seven as literate. Thus, a more holistic, multimodal approach to understanding meaning-making in early years needs to be applied.

Multimodal approach to literacy development is based on the premise

that meaning-making experiences are facilitated by different representational and communicational resources, and language is just one among them (Kress & Leeuwen, 2001). Musolf (1996) described children's physical movement of running, jumping and laughing together as equivalents of talk or conversation. Such jumping and running may not appear as meaningful and a social activity to adults as much as it is to children (Corsaro, 1986). In the early school context, multimodal approach to literacy development supports children's experience of learning and development. Through such performance of running or laughing together, children generate a feeling of control over their lives. Sociodramatic play is linked to early literacy development in the way that it is "characterized by symbolic representation, imaginative use of language, role-taking, social interaction, and sustained play activity" (Roskos & Christie, 2011, p. 74).

Literacy is based on skills and practices that are considered more valuable than the others in societies, and therefore literacy can also be understood as a set of culturally defined practices and skills (Menon et al., 2017). It is seen that literacy activities in the classroom are based on more valued skills in the society, that of reading and writing. The skills of reading and writing are generally associated with success in academic examination as well as securing employment in adult life.

Children's understanding of literacy activities and its meaning is influenced by their use of reading-writing activities in everyday life at home, in school and other contexts (NCERT, 2006). Literacy development for many children is fostered at school as they enter the pre-school with a sense of sensitivity to letter and word forms or 'concepts of print' (Clay, 1998, p. 111). This perspective suggests that children have already learnt to use language in print when they enter pre-school and they make a back-and-forth movement between individual learning and collective learning (McLachlan & Arrow, 2017). While this may be true for

children with some exposure to print at home, it is not the case with many others who may hold a book for the first time in the school.

Neuroscience research informs that neural development during early years is rapid and is foundational for learning and development. Neurons are basic building blocks of brain that function to communicate messages in and from the brain to the body. Synaptic connections among unused neurons decrease while "new discoveries (child's activity) maintain synapses" and therefore, early responsive "relationships with caregivers, stimulating environments and an engaged, active child" together form a "system that shapes brain development" (Gallagher, 2005, p.13). Research has established that a variety of sensory experiences are required for a developing brain to maintain its neural material (Jewitt & Phillips, 2000). Moreover, literacy development in early school years is contingent on responsive relationships at school, and thus quality of teacher-child relationship has a bearing on it (National Scientific Council on the Developing Child, 2009).

A study in government schools of Delhi found that teachers were confused when they were confronted with language textbooks that had meaning making at its center rather than teaching script decoding skills (Jayaram, 2008a, 2008b). Another study in a self-financing school in Delhi, noted that in a trilingual early literacy context, teachers would position their pedagogical accounts within the social-context of large class size, parental expectations and short daily duration for literacy instruction (Sen, 2017). Thus, understanding teachers' understandings and experiences are important. This is one of the missing pieces of the literacy puzzle of Indian education system, where many children find it difficult to gain basic skills of reading, writing, comprehension (ASER, 2019).

Research findings discussed in this paper are a part the doctoral research study being conducted by the Department of Human

Development and Childhood Studies, University of Delhi. This paper presents a slice of findings for one of the objectives dealing with the understanding of teachers regarding early literacy in school. The following sections discuss epistemological assumptions, research design and methodology of the study as relevant to understand the context of this paper. It also describes the methods used and provides data analyses.

Research design and methodology

This study is embedded in the interpretivist research paradigm. It means that humans interact with each other and construct a shared and individual meaning of the reality. This social construction of meaning is made possible by the use of language resource. Social reality can be accessed through language as people exchange thoughts, experiences, perceptions and opinions through talking in shared language resource (Willig, 2013; Charmaz, 2014). Words become realities in the social world. The sociocultural perspective of literacy development considers that it is within the cultures of their communities, families, schools that children become literate (Kantor, et al., 1992). This also means that literacy development experiences are organised within the sociocultural background of schools that are located within the larger context of national policies, curricular frameworks, legislations, programmes and cultural ethos. This study is an ethnographic exploration of teachers' lived experience in early literacy school setting, in an attempt to interpret their literacy development experiences as co-constructed in everyday school activities. The objective is to understand what meaning do teachers assign to their practices in the context of early school literacy.

Context and participants >

The research sites are three primary schools in East Delhi. One is a private, unaided school with air-conditioned classrooms, amphitheater, playground and functional

library facilities. Two of the remaining schools are managed by the local municipal body and did not have a functional library. The official languages in these schools were English, Hindi and Punjabi. Punjabi was the third language in the municipal school alone, introduced in the Class III. The medium of instruction in the private, unaided school was English for all classes. One government school used only Hindi language as the medium of instruction. While the other school had each class divided as per English language instruction medium and Hindi language instruction medium. The average class size was thirty-three across the three schools.

The schools were purposively selected from among low-to-medium fee-charging private and no-fee charging municipality schools, the consideration being that majority of children attend low-to-medium fee charging private schools or government schools in Delhi. The schools available in one residential area of East Delhi were identified and contacted for permission.

Fifteen teachers of the three selected primary schools were the participants in this study. They taught children in the age group of 3–8 years, in the pre-primary classes I and II. All teachers had the requisite teaching educational qualifications. Eight teachers had teaching diploma in elementary education, seven had Bachelors in Education or Bachelors in Elementary Education. Additionally, eight of the teachers had a master's degree. Four teachers had more than twenty years of teaching experience, three teachers had more than ten years of experience, eight teachers had under ten years of experience, of whom two were teaching for the first time in school.

Data collection method of interview

Interview as a method of researching the experiences of teachers is based on the assumption that language resource can be utilised to access teacher's lived experiences (Willig, 2013). The interviews were carried out with the belief that the participant teacher



had “experiential expertise” regarding literacy development in school (Smith et al., 2009, p. 65).

Each teacher was interviewed thrice over a period of six to nine months. Interviews spread over a longer period accounted for “idiosyncratic days and to check for internal consistency” of what the teachers said (Seidman, 2005). The interviews were primarily bilingual.

A semi-structured interview guide served as a “virtual map” helping the researcher to be an attentive listener, more flexible and a responsive interviewer (Smith, et al 2009, p. 59). The interview guide had components that were designed to draw out teachers’ views and understanding on a range of issues pertaining to literacy pedagogy, children’s literacy work in the classroom and selection of literacy activities conducted.

Field notes were documented in addition to interviews. Observations from the field were recorded in the field notes diary, after the field visit, on the same day. This would help to contextualize interpretation of teachers’ experience in the given socio-cultural context.

Data analyses

Thematic analysis of interview data was carried out. The interview transcripts were analysed for teachers’ responses and categorised according to emerging themes and patterns. Responses were sorted into categories and codified using relevant theoretical frameworks to systematically refine and review themes and patterns related to literacy development in school.

Methodological journal in which the methodological dilemmas, pathways and research decisions were recorded along the fieldwork fed into analytic work. I continued to elaborate on codes as new questions were asked from the data while assigning them to categories and concepts.

In accordance with the ethical code of conduct in social sciences research, all participants were provided with research

information before they gave their consent for participation. It was an ongoing practice to seek participant’s consent all through the fieldwork period.

Literacy development in school: teachers’ voices

The discussion presented here is a conceptualisation of a response to the research question: what are the teachers’ understanding and experiences about literacy development within the school setting.

Though ‘literacy’ is a commonly used term, different teachers viewed it differently, according to the context and age of their students. The meaning of literacy for teachers was also determined by what they considered its purpose and importance in a child’s overall development and education. Their own pre-service training and continuous professional development, education and teaching experiences also informed their ideas about what constituted as literacy activities in the school context. Moreover, the school emphasis and culture and the curriculum/syllabus and textbooks they used to teach also informed their idea of literacy development in school. Here I discuss the different ways in which the participant teachers understood and related with early literacy.

Preparation for next class

A common thread in teachers’ experiences of working in early literacy classrooms was that of preparing children for the next class. This preparation, however, was unique and highly coloured by the school culture and vision about literacy development. In one school site, this preparation constituted training in copywriting, understanding basic print concepts of directionality, recognising alphabets and *akshars*, tracing shapes, drawing lines and colouring on paper. Writing was considered as the most important of all literacy skills. As children progressed from one class to the other, the number of

workbooks and textbooks prescribed as per the school curriculum increased. Children who could write by copying from the teacher's writing board were considered developing literacy skills. Teachers commented that the purpose of preschool is to make children ready for early primary classes and so on. This means that the activities that were conducted in their classroom were carried out with the intent of preparing the child for the next class or level of schooling. A preschool teacher explains:

“When you (researcher) will come in November, you will see that they have started writing their diary (a note for work to be done at home). Although I write it on the board, yet they will learn to write within the lines, so they are ready for Kindergarten.”

Some teachers shared that focusing on the text-decoding skills was important to their teaching practice. They insisted that children would not understand anything as narrated and illustrated in the language textbook unless they could read the text. Illustrations were not seen as aiding meaning-making and comprehension. A teacher asserted that only words conveyed meaning in a textbook. A Class II teacher shared the reason why they did not use the available language textbook in their class:

“They (children) cannot read long stories given in the prescribed language textbooks. To read such long stories, they need to know the alphabet sounds and learn to blend those sounds.”

Few teachers complained about the quality of content in textbooks. The long stories, as per a few teachers, did not account for children's not-yet-developed skills to decode the text. When asked whether children liked short stories for their brevity, it was observed that it was linked to the limited development of children's literacy skills and not a limited attention span. There are state-prescribed textbooks that are viewed as non-usable by the teacher. In this situation, the pedagogical intent of the available text resource is lost. The school curriculum required both English and Hindi language learning, but a teacher

cited the reason of limited instruction time. They explained that acquisition of text decoding skills in one language consumed most of their teaching time and that second language instruction was not relevant to their class. For this reason, they had decided not to teach the second language and had asked children to not carry the English book to school when it was not needed.

Teachers' ownership of the prescribed literacy materials and agentic practice

When teachers were involved in the process of curriculum development and literacy material creation, they owned the literacy development context more readily. This sentiment of having been an active part of the process of workbook creation was conveyed by a pre-primary class teacher that made them more aware of their literacy instruction practices. They were not particularly satisfied by the content in the literacy workbooks for children in their class. Nevertheless, they voiced their autonomous actions in the following comment:

“We really wanted less writing and more interaction. Though you have seen the book, that's not as up to the mark as we had wanted it to be...but as per the demand of the school curriculum, it's perfectly okay...so those books are good...we wanted children to use their brain...they should find independently, “where is that picture?”... In the book, I am giving things with p only. But they will find that there's b-b-b bench also (in p-p-park). So I ask them what else they see in the park.”

The teacher ensured that they asked students questions about the content, helping them expand their thinking and build linguistic awareness. Their intention was to plug the missing links in the available literacy workbook through a responsive, timely and aware questioning strategy. What is described by the teacher suggests that given their reflective and aware instructional practice, they were able to navigate the challenge posed by the prescribed literacy material. It also connotes that they had control over the pedagogical processes and



were not stopped by anything outside of their classroom.

Thus, some teachers' understanding conveys that textbooks, workbooks and primers are meant to facilitate comprehension in the process of literacy development. These available literacy materials are viewed as aids for bi-literacy development. Also, that it was a particular teacher's literacy experience that determined their perceptions about the textbooks. It also got highlighted that the teachers who participated actively in the process of development of prescribed textbooks and other literacy material, expressed ownership and autonomy with regard to literacy material and its use for learning.

Drawing for literacy development

Moving beyond language, literacy development as per teachers' experiences includes drawing and coloring pictures or figures as a meaning-making activity. Many teachers shared that they used drawings and illustrations in their literacy instructional practice. They used it as a visual aid for literacy instruction. Some preschool teachers also instructed children to draw objects along with *akshar* writing to make the sound-symbol correspondence as well as meaning making through illustration. A pre-primary class teacher explained their use of illustrations for literacy transactions in class: "The idea is to help students make pictures for the recognition of Hindi *swar* or vowel, and if they see the vowel from that picture anywhere else, they will be able to read it. Then, if they see an ambulance, they will know that it begins with a combination of vowel and consonant in Hindi."

Beginning in Class I, a few teachers tried contextualising children's experience by providing them opportunities to draw more than writing. They explained that many children in their class had limited, irregular to no preschool experience and thus, they needed to do more drawing and colouring activities in school before they were given writing drills. A teacher of Class I indicated

in their understanding that drawing was a precursor to writing skills:

"Colours are the best part...children enjoy colours and it helps them develop understanding about writing processes." Other teachers shared that they had observed that children's drawings were supplementing their literacy development and learning experience at school. However, drawing could only be done in the free period as described by a teacher of Class II in their comment below:

"I tell them to draw in their free period; they draw such beautiful pictures and what we studied in science class...they draw (illustrate) what they had read in books. They feel happy, I give them special time to draw in their old notebook." A teacher voiced that school activities were made to keep children busy and that giving them special time to make drawings was an important practice in their early literacy classrooms. Describing the significance of drawing activity, teachers explained the reasons. First, it was free drawing initiated by the child. This work on paper was not evaluated because it was done in their old notebook that was not used for class work anymore. Thus, no pressures of making the pencil move a certain set way. They could draw anything they wished. It also gave them break from the drill writing exercises. They may be really involved in the process of creating a visual, picture, representing an idea that could be either inspired by their science book imagery or totally unrelated to the textbooks and curriculum. The teacher showed some of the children's rough drawings to the researcher. It was interesting to note that teachers talked pleasantly about the children's drawings only when they permitted them to do so. They did not correct or evaluate those creative work of children because (a) it was not required as per school syllabus and (b) there would be a pile of notebooks and books for them to evaluate children's literacy work on the same day. That was communicated as a big relief for both children and teachers. Thus, the teachers in this study affirmed that drawing

and coloring activities promote and make literacy development enjoyable for young learners in their classrooms.

Questioning for comprehension

Questioning as a strategy to evoke verbal response from children during digital story sessions was also viewed as a strategy to involve children in conversations about the characters, events in the story. A Class I teacher, while talking about their pedagogical practice, referred to a class activity where they made use of the phone screen to project audio-visual story for their students. They shared that they would bring the bluetooth speaker from home so all children would hear the audio properly even if the video was not visible to all. They further explained that they checked for narrative comprehension by pausing the story playing on the phone screen and asked questions to test children's understanding of the plotline:

"I keep asking questions during the storytelling session so that I get feedback about the story. Are they liking it... Are they following the story? When they answer, I resume playing the story on my phone." It was noted that children added to the story when the teacher asked them an open-ended question. At the heart of asking an open-ended question is the teacher's intention to provide opportunity for the child to articulate and imagine (Joshi & Shukla, 2019). This way the child remains an active participant in such shared meaning-making exercise. At the same time, when children ask questions in a group setting or class, teacher's responsiveness bolsters their confidence of expressing freely in diverse social situations. Concurrently, the teacher believed that six-year-old children in their class were old enough to pick up a storybook and read it. They explained that using their phone was merely a way of helping children develop listening and comprehension skills when in reality they did not have access to a variety of age-appropriate children's literature or texts in school.

Navigating parental expectations about literacy development

Another aspect is that of exclusive focus on helping the child first master decoding the languages driven by the parental expectations about literacy acquisition. How teachers managed to navigate through those demands has implications for school literacy development practices. Teachers experienced a disjunction between their training (both pre-service and in-service) and their practice in the given school context. This created dilemmas and confusions for the teachers that had a direct impact on the young learners' literacy development experience.

One of the schools did not lay much emphasis on the early introduction of writing tasks, but colouring activities were considered promotive for children in the pre-primary school years. However, teachers shared that parents demanded their child learns to write the alphabet and letters starting at three years of age in the pre-school. Thus, teachers experienced dilemma over introducing copywriting in their early literacy work at school. It seemed counter-intuitive for the educator to instruct a child to do copywriting drill exercises as evidence of learning work at school. Teachers at this site explained how they felt that children were not ready for such focused and enforced way of being with the text. A pre-primary teacher lamented:

"There is no writing work in the syllabus for three- to five-year-old children. Yet, I do a little bit writing with them, otherwise their parents are not satisfied... If it were upon me, I would have never pressurised children to write before they are ready for it." While reflecting on their learning from pre-service training, yet another teacher confirms her agony in the following words: "I fear it may put off children from learning altogether... they will not want to come to school... It is not good for their motor skills... This is what I have learnt in my training... soft tissues get damaged... Drawing is fine, but colouring is easier for them. You must have observed



that I give them drawings to fill with colours, first they will learn colouring and gradually learn to hold the pencil to write.” Teachers’ experiences suggest that meaning-making in the early literacy classroom gets sidelined because of factors external to the classroom. Some of the reasons why teachers reported being helpless was attributed to private schools’ practice of making children fill notebooks (writing exercises) beginning in pre-primary classes. They explained that parents would compare their child’s academic performance with those of other children studying in private schools and appeared fearful that their child would be left behind in the race of writing development. This also suggests how teachers’ agency is trampled upon by external influences, as they work to provide for literacy development in school. Influences external to classroom impact organization of literacy development experience for children. Thinking or meaning-making is central to learning, and this needs to be considered in the organisation of literacy experiences at school.

Conclusion

Literacy experiences at the elementary stage of schooling lay the foundation of future

learning and life as a responsible citizen of a democratic society. It is in the early years classrooms that children imbibe joyful feelings for language and literacy experiences along with developing foundational neural connections for languages in their sociocultural context. Teachers’ understanding, experiences and views about early literacy get translated into early literacy experiences of children in school. Teachers in this study expressed that they experienced conflict in their actions and beliefs regarding early literacy in school. Some of their actions seemed to be aligned by factors, such as the unavailability of age-appropriate and relevant literacy materials and parental expectations of literacy. They seemed to be held back from their own conviction about developmentally appropriate literacy practice. Teacher development programmes need to provide support for mitigating these contextual issues. It appears that teachers’ conviction of providing young children with the opportunities for exploration and self-expression in early years of schooling is constantly at war and dying because of the popular yet incomplete definition of literacy, as operating in the current education system.

References

- ASER. 2019. *Annual Survey of Education Report (Rural)*. ASER.
- Charmaz, K. 2014. *Constructing Grounded Theory*. Sage.
- Clay, M. 1998. *By Different Paths to Common Outcomes*. Stenhouse Publishers.
- CORSARO, W. 1986. Routines in Peer Culture. In J. C. Gumperz, W. A. Corsaro & J. Streeck (Eds.), *Children's Worlds and Children's Language* (pp. 231–252). New Babylon.
- GALLAGHER, K. 2005. Brain Research and Early Childhood Development: A Primer for Developmentally Appropriate Practice. In *YC Young Children*. Vol. 60, No. 4. pp. 12–18.
- JAYARAM, K. 2008a. Early Literacy Project—Explorations and Reflections Part 1: Theoretical Perspectives. *Contemporary Education Dialogue*. Vol. 5, No. 2. pp. 133–174.
- . 2008b. Early Literacy Project—Explorations and Reflections Part 2: Interventions in Hindi Classrooms. *Contemporary Education Dialogue*. Vol. 5, No. 2. pp. 175–212.
- JEWITT, P. AND D. PHILLIPS. 2000. *From Neurons to Neighbor Hoods: The Science of Early Childhood Development*. National Academies Press.
- JOSHI, P. AND S. SHUKLA. 2019. *Child Development and Education in the Twenty-First Century*. Springer. doi: 10.1007/978-981-13-9258-0
- KANTOR, R., M. SANDRA, AND E. D. FERNIE. 1992. Diverse Paths to Literacy in a Preschool Classroom: A Sociocultural Perspective. *Reading Research Quarterly*. Vol. 27, No. 3. pp. 184–201.
- KRESS, G. R. AND L. T. VAN. 2001. *Multimodal Discourse: The Modes and Media of Contemporary Communication*. Arnold.
- Kumar, K. 2000. *Child's Language and Teacher*. National Book Trust.
- McLACHLAN, C. AND W. ARROW. 2017. Conceptualizing Literacy in the Early Childhood Setting. In C. J. McLachlan & A. W. Arrow (Eds.), *Literacy in the Early Years Reflections on International Research and Practice* (pp. 1–20). Springer.
- MENON, S., R. KRISHNAMURTHY, S. SAJITHA, N. APTE, A. BASARGEKAR, S. SUBRAMANIAM, M. NALKAMANI, AND M. MODUGALA. 2017. *Literacy Research in Indian Languages (LiRiL): Report of a Three-year Longitudinal Study on Early Reading and Writing in Marathi and Kannada*. Azim Premji University and Tata Trusts.
- MINISTRY OF HOME AFFAIRS. 2011. *Chapter VI: Literacy of Rural-Urban*. Government of India, New Delhi.
- MINISTRY OF STATISTICS AND PROGRAMME IMPLEMENTATION. 2020. *Household Social Consumption on Education in India*. Government of India, New Delhi.
- MINISTRY OF HUMAN RESOURCE AND DEVELOPMENT. 2020. *National Education Policy*. Government of India, New Delhi.
- MUSOLF, R. 1996. Interactionism and the Child: Cahill, Corsaro, and Denzin on Childhood Socialization. *Symbolic Interaction*. Vol. 19, No. 4. pp. 303–321.
- NATIONAL COUNCIL OF EDUCATIONAL RESEARCH AND TRAINING. 2005. *National curricular framework*. NCERT.
- . 2006. *National Focus Group on Early Childhood Education*. NCERT, New Delhi.
- NATIONAL SCIENTIFIC COUNCIL ON THE DEVELOPING CHILD. 2009. *Young Children Develop in an Environment of Relationships*. Harvard University.
- ROSKOS, K. A., AND J. F. CHRISTIE. 2011. Mind-brain and Play-literacy Connections. *Journal of Early Childhood Literacy*. Vol. 11, No. 1, 73–94. <https://doi.org/10.1177/1468798410390889>
- SEIDMAN, I. 2006. *Interviewing as Qualitative Research: A Guide for Researchers in Education and the Social Sciences*. Teachers College Press.
- SEN, S. R. 2017. Literacy in Pre-primary and Class 1: Processes of Teaching and Learning in a Trilingual Environment. In N. Rao (Ed.), *Disciplinary Dialogues on Social Change - Gender, Early Childhood and Theatre* (pp. 93–130). Academic Foundation.
- SMITH, J. A., P. FLOWERS, AND M. LARKIN. 2009. *Interpretative Phenomenological Analysis: Theory, Method and Research*. Sage.
- VYGOTSKY, L. 1986. *Language and Thought*. MIT Press.
- Willig, C. 2013. *Introducing Qualitative Research in Psychology*. McGraw-Hill Education.

Neelima Khetan
neelima.khetan@gmail.com
Hriday Kant Dewan
hardy.dewan@gmail.com

Re-emphasising the Physical School: Lessons from COVID-19

Background

COVID-19 brought about several unforeseen situations. One of them was the virtual locking up of children and their inability to go to schools or anywhere else. They missed their peers and their friends, their school and their classrooms, their freedom and their exploration, and for many, their midday meals too. Not surprisingly, given the overwhelming fear of the pandemic, these concerns about what was happening to children lay buried for a long time. Even when the conversation began around school closure, it was largely around the learning gaps that were accruing consequent to the loss of school time. There was pressure on the system to start some teaching process so as to mitigate the time lost and urgency for the school to start doing something to ensure that children were occupied with studies and did not lose out.

This anxiety took time to surface since initially the pandemic was viewed as a temporary phenomenon. The urgency of just managing the everyday amidst severe restrictions that had been imposed overshadowed much else. Another reason for the delayed anxiety was that the lockdown began close to the annual school vacations and the worry about missed learning began to mount only after the vacations were over and the pandemic was still all around us. The anxiety around missed learning and the absence of contact possibility, naturally led to a demand for online classes, and very soon, there was pressure on all schools (and teachers) to begin online classes.

Online educational software companies suddenly found a huge market and put this opportunity to good use in order to make money. A vernacular Hindi newspaper carried a headline a few months back stating that educational apps had added tens of crores of new members, and just one channel had added 40 million new accounts in the last few months. There have been many webinars and conversations around online education, and the advertisements to join these have increased too.

However, this spurt in demand for online educational platforms is not merely a pandemic-induced phenomenon. This is a part of the growing discourse on individual-focused programmes and the need to overcome learning gaps through technology. There has been a push towards reducing the human cost in the teaching-learning process and that can be done through technology.

A May 2017 study conducted by KPMG and Google titled *Online Education in India 2021* had envisioned an 800 per cent growth for the online education industry. The study had stated affordable online education as the cause for this spurt. It further added that online education could attract those who have surplus income and want their children to get special coaching. It anticipated a large increase in the primary and secondary supplemental education expense. They expected that this would add to but also displace the tuition market¹. Clearly the education industry has been attempting to access the increasing surplus

1. Online Education in India: 2021 - KPMG India [https://home.kpmg/~/media/Images/P/Practicing%20Members/Insights, May31, 2017](https://home.kpmg/~/media/Images/P/Practicing%20Members/Insights/2017/05/2017-05-31-Online-Education-in-India-2021.pdf)

in some families and their willingness to spend more on education. There has been a push towards fueling parental anxiety and offering exclusive learning software to help children be better prepared for competitive situations.

It was, therefore, no surprise that the lockdown triggered these anxieties of middle class parents leading to the push for online classes in elite schools. The schools were also keen to start such a process so as to build a case for collecting fees. Slowly similar concerns about the accumulating learning gap in case of poor children also started to be expressed. This required attempts at providing some kind of online education to these children as well. For both the low-cost private schools and the government schools, the challenges in the way of starting something and also having an inclusive classroom were many. This paper questions some of the premises inherent in these discourses and presents the experience of online teaching in schools during the pandemic.

This paper began with the authors' desire to understand the perception towards online education on the ground. The authors saw reports from surveys with teachers and parents but wanted to hear it directly from children to ascertain how they felt about online learning and staying away from school. This paper tries to capture insights from a quick assessment of school children in Alwar, and how they viewed the experience of education during this period. The authors also summarise some other studies and present the essential principles that should form the basic tenets of the way forward for education post pandemic.

The study with children and some teachers

The motivation for the conversations with children was to understand the crisis, the lockdown, the continued physical distancing and its effect on children. In this study, 97 children were interviewed. They comprised

a purposive sample that could be contacted over phone and agreed to these interviews. The structured interviews were recorded and data mined from the recording. The sample comprised 76 private school students and 21 government school students. Of the 97 children, there were 32 girls and 65 boys. 10 children were from the age group of 4–7 years, 70 from 8–15 years and 17 children were between the ages of 16–20.

Most of the children came from low-income families, with 51 per cent stating their fathers were daily wage labourers. A majority of the parents of government school students were only educated upto the primary level (55 per cent of fathers and 80 per cent of mothers), while a larger proportion of the parents of private school students have an education level above primary school (only 16 per cent fathers and 38 per cent mothers did not go beyond primary school). A majority of students were not happy with online classes. Girls were more dissatisfied with online classes (75 per cent girls compared to 65 per cent boys who did not like online classes). This could be because the closure of physical schools for girls meant greater confinement within their homes and the added responsibility of housework. It could also be because girls may have had lesser access to mobile phones necessary for online classes.

The very young children (below 7 years) were all unhappy about the online classes, with older children liking them a little bit (only 26 per cent of children between 8–11 years and about 36 per cent of children older than 12 years seemed to like the online classes). Interestingly, the private school students seemed to have a worse perception of online classes than those of government schools (68 per cent versus 50 per cent). While our sample is too small to provide a clear insight, but this could be because children from government schools are from poorer families with lower expectations.

We also asked students what they missed the most about school. For most children (48 per cent of private school children and



40 per cent of government school children) what they missed most was 'playing with friends'. The second most missed thing about school was 'talking with teachers' in case of government school children (30 per cent) and 'studies' in case of private school children (29 per cent).

These findings, even from a limited sample, corroborate with inferences from the studies done by Oxfam India², Azim Premji Foundation³ and the survey of Dainik Bhaskar⁴. According to the Bhaskar survey (carried out across 12 states and 65 districts, with a sample of 1,500 parents, teachers and students), nearly 93 per cent parents, 92 per cent students and 97 per cent teachers prefer face-to-face teaching and learning. Teachers state that face-to-face interaction gives students greater self-confidence. In all the studies, an overwhelming number of parents and teachers of all backgrounds were seen to be unhappy with online classes.

The study by Azim Premji University was conducted in states that were attempting to implement state-level online classes and some other states which did not have any state level intervention. The study is based on data received from around 400 parents and 1,500 teachers of government schools across 26 districts. According to the study, teachers were frustrated with online classes and found that one-way communication was very difficult. Teachers also admitted to being ill-prepared for online classes and felt handicapped both by the lack of emotional connect with children and the absence of any meaningful assessment of learning. They felt that the time available for online classes with each grade was much less than normally available in a face-to-face teaching-learning situation. The actual time for which

online teaching is possible is even smaller as a lot of time gets wasted with connections dropping and delayed responses. The parents shared the view that online classes have failed to be effective, and 90 per cent of those interviewed were in favour of opening schools with safeguards. Most of them in fact felt that opening schools would not add any additional risk. The study reports an access to technology gap and points out that 60 per cent of students lack access to online classes.

The study done by Oxfam reports that 80 per cent of government school students are excluded from online classes due to lack of digital equipment. This is in alignment with the global studies that show that workable digital solutions are not possible without adequate and appropriate digital infrastructure being available. In fact, the Oxfam study points that it is not only students but also teachers who lack appropriate devices and bandwidth to access online classroom and teach. As in the other studies an overwhelmingly large number of teachers in these studies found delivering classes digitally challenging and difficult.

Another piece of input is from a detailed conversation with the Principal⁵ of a mixed clientele school whose teachers had engaged in online classes. He shared many insights from the focused individual conversations he had had with his own teachers as they started conducting online classes. Some common concerns clearly emerged. Many children whose parents were daily wage workers had lost their livelihood. This affected their whole life, of which education was a small part and thus, not an immediate priority. This school is partially residential with a mixed community of students—while some on government scholarships are from rural poor families and local low-income families, others come from relatively better-off families as day scholars). The poorer and the rural students were hit the hardest. However, it is not as if the middle class children were unaffected—they too were neither happy

² Vyas A 2020, status report-Govt and Privat schools during Covid-19 Oxfam India <https://www.oxfamindia.org/oxfaminaction/status-re...> 04-Sep-2020

³ Azim Premji University, (2020) Myths of Online teaching, Field studies in Education, September 2020, Bangalore

⁴ Dainik Bhaskar (2021) page 1, Feb 4, 2021, New Delhi, Published in Rajasthan edition

⁵ Pushpraj Ranawat, Principal, Udaipur

with the classes nor with their inability to meet friends or come to school.

The teachers noted that in addition to formal teaching sessions, children needed some interaction and sharing. They recognised that the school lacked sufficient information about the extent of digital access of students and struggled to reach them initially. They pointed out that poor children and those living on the outskirts of the town as well as the countryside were unable to join classes, and that the rural-urban divide was staggering. Mostly, these students could not have access to a device and even if they did, connectivity became the reason for their not being able to participate in the classes. It was difficult to find a quiet space for study in the house or academic support for learning. The extent of support that parents could provide in spite of their interest in education and well-being of their children was extremely limited, and many children just gave up. The teachers felt that for many children this gap would be difficult to overcome and feared that many children would not come back to school. They feared that for some children education may suffer permanently.

Teachers also shared their impressions about the online classes. They were unhappy with the experience. The most critical factor mentioned was the lack of a connect with students and also among students themselves. During online classes, the teachers felt disengaged as they could not get any cues from the students. They felt that the extent of active attention was very short and many students were likely to lose network connectivity in between or be non-responsive under the excuse of poor network connectivity. Teachers also felt ill-prepared to suddenly take online classes but felt that even after a lot of effort, this could not be an effective mode of teaching for their students.

However, while the teachers seemed unhappy about online classes and their inability to connect with students or assess their learning, they also felt there had been some changes in their attitude

and relationship that may influence future work. They felt that they had developed a communication with parents, understood parents' concerns and also realised how parents could somehow support the learning efforts of their children. In spite of the academic unpreparedness of parents to support their children's learning efforts, they were still able to scaffold it in many other ways.

Teachers also felt that the WhatsApp communication groups with students will most likely continue to supplement classroom interactions, even after schools reopen. They were also happy that they had learnt new pedagogical tools, such as e-worksheets and the use of online resources. Some occasional training sessions became possible as people could connect on the internet. This would become far more effective when face-to-face meetings start. Teachers also recognised that the concern of parents about the education of their children had become evident during this period. They now believed that there can be collaborative efforts between them and the parents to help facilitate learning among children.

The opening of schools

As concern for education grows among parents, it is very likely that schools will reopen soon. Many states have allowed both secondary as well as upper primary schools to open. As schools open, fears of large number of students (up to even 40 per cent) dropping out and the immense learning gaps have been expressed⁶. While there have been anxious suggestions to develop capsule modules to facilitate faster teaching so as to cover the gap, there are also voices recommending a slower pace to ensure assimilation and bringing the rhythm of learning and children back to the school.

⁶ Behar Anurag (2021) <https://www.livemint.com/opinion/columns/our-children-should-not-have-to-pay-the-price-for-our-follies-to-day-11611765264097.html>, Compounded loss of learning Mint, Updated: 27 Jan 2021, 10:08 PM IST



Among all this is the overarching fear that life would not be the same even after this pandemic is over. Education and schools would have to be structured somewhat differently and would need to be re-conceptualised keeping in mind the need for physical distancing. There have been two divergent recommendations in this direction. On the one hand, there is the urge to move towards more and more technologically driven solutions for students. However, as mentioned earlier in this paper, this push is not merely an outcome of the pandemic. Much before the pandemic, the technological push was driven by the need for a greater opportunity to self-learn, thereby allowing each student to follow his/her own pace and method. Studies have been showing an increasing market for online education for some years now.

At the level of development, a lot of effort is going into attempts to optimise and improve the delivery products for the online learning market. The underlying belief is the faith in such technological solutions and artificial intelligence to function as teachers or at least as guides⁷. In fact, several products are directly for students and do not require mediation by teachers or any other adults. This is along the almost axiomatic belief held by many people about the need to provide individual trajectories of learning for each student. Their belief is that this task can neither be left to the teachers nor to peer exchanges and the learning derived from that⁸.

In this respect, there are two major concerns that emerge for India. One is about the meaning and purpose of education and pedagogy and the second is about the resource feasibility of such an alternative.

There may be other dimensions of concern, like the impact on health due to increased screen time, and the emotional loss in terms of being with peers and even interacting with adults. The points of concern with respect to resource feasibility are around both the software and the hardware of online education. Studies and surveys with children, teachers and parents show a common fear. The fear is that over 85 per cent of rural children could be excluded from this process as they cannot access the internet⁹. These numbers may have improved a bit by now but they are still far from being inclusive particularly for Dalit, Adivasi and Muslim children. Besides, as our study and other studies have found, it appears that women and girls have much lower access to devices that can use the internet. Then there are concerns around the instability of internet connections, the lack of adequate bandwidth and the cost of data. While some of these constraints may get diluted over time, there are deeper concerns around the very meaning of education, which are less likely to go away.

The concern of teachers and parents has resulted in the setting up of small '*mohalla* schools' at some places. Some of these have been supported or set up by non-governmental organisations working for education of children. But in each of these situations, the *mohalla* schools have been strongly supported and at times even led by government school teachers as well. The enthusiastic contribution in the functioning of these and the participation of almost everyone in running them is indicative of the role a school can play in the life of parents, children and entire communities¹⁰.

7 Addressing the Strengths and Challenges in the EdTech world during Covid-19 and beyond Webinar (2021) Edufront CodeFest 2020 The Bug stops here, Jan 15, 2021, 5 30 PM, available at <https://www.youtube.com/watch?t=863&v=WEajV-FIplU8&feature=youtu.be>

8 <https://www.india-briefing.com/news/investing-indias-education-market-after-covid-2019-new-growth-drivers-20330.html/>

9 Vyas A 2020, status report-Govt and Privat schools during Covid-19 Oxfam India <https://www.oxfamindia.org/oxfamination/status-re...> 04-Sep-2020

10 Transform Rural India (2020) Restoring Childhood and Missed Schooling : Mitigating COVID losses in rural Primary Schools, Webinar Aug 5, 2020 <https://www.facebook.com/TransformRural/videos/293412735214667>

Way Forward

The need for closer human contact and fraternal feeling is a must-learn from the pandemic. As we re-envision schools, we must take cognisance of children and teachers' own sense of absent real-time contact. There is a need for the system to become aware of what the school means in the lives of children. For most children the authors spoke with, the school is not merely a place of learning, but it is a space which belongs to children in a very wholesome way. Online and individual pathways to learning may help achieve the learning objective of school (though even that seemed suspect in the authors' interrogations), but this is the one place where children from different ages, castes, classes still come together (even though intra-school diversity is now much lower than earlier). It is a space that they miss very strongly when denied. It is not just a meeting ground with friends or a place to escape to or a place with books and for study, but a complex mixture of all this—one that provides a unique experience to students. With new lessons from the pandemic, the system can strive to make this place much more the space for and of children.

The second concern we should have is the way we deal with the after-effects of a long absence of education for children during this period. Do we take account of the break and therefore start with going over already covered ground, or do we fret about the 'learning gap', and push more inputs and press the schools and children to catch up? Is the most crucial thing at the moment to make children feel adjusted and comfortable in school and consider themselves capable, or should we hurry with a shortened capsule-kind input? Should students be allowed to take their time and schools and teachers work with them with the confidence that all students would eventually learn? Can we avoid a centralised imposition of ideas and methods that are generated by 'experts' and leave the effort to improve to the collective sensibility of school teachers? This can be done in partnership with parents. This would require allowing a specific methodology to emerge from the ground situation keeping in mind the broad perspective of education, its purposes, principles and key ideas of the syllabus and pedagogy as per the NCF 2005 and NEP 2020.



Manasi Thapliyal Navani

manasi@aud.ac.in

Shivani Nag

shivani@aud.ac.in

The emergent transition to remote learning online: A study of the experience of students' doing postgraduation in education

Abstract

This paper attempts to examine and situate the experience of students enrolled in two postgraduate programmes in the discipline of education during the pandemic. The lockdown introduced in response to COVID-19 pandemic entailed a sudden and abrupt shift to the online mode of teaching. In order to understand the efficacy of the online classroom space for students preparing or studying to be teachers and teacher educators, it is important to reflect on the nature of the discipline of education and the current context in which the transition to online learning happened. This transition was not an outcome of a systematically planned academic experiment or endeavour. This paper builds upon narratives emerging from the responses of students pursuing postgraduate degrees in education, and early childhood care and education. The responses to an open-ended questionnaire, semester-end student feedback forms on courses taught in an online mode, periodic informal interactive sessions with students over a period of seven months, and participant observations conducted by the authors in a School of Education Studies in a university in New Delhi were gathered. The informal interactions and group discussions with students were facilitated by the authors' location as faculty in the same department. The intersubjective space thus created between the participants and the researchers, allowed a closer engagement with everyday challenges and students' reflections and experiences. The paper draws from the interpretive paradigm and attempts to examine how students experienced the digital pedagogic space and this transition to online learning.

Introduction

The global COVID-19 pandemic has impacted the world in an unprecedented manner, affecting and influencing virtually all of activities and structures. In India, the nation witnessed a complete lockdown beginning in the third week of March that continued for months till almost July 2020. The pandemic also resulted in the closure of schools and higher education institutions (HEI) from March 2020 across the globe. This was followed by a sudden shift to online education. Apart from being mid-course, the "suddenness" of the shift also entailed an unpreparedness on the part of educational institutions, faculty and students—in terms of both infrastructure as well as necessary skill sets. In the context of programmes that facilitate students to become early

childhood teachers, educators and teacher educators, the very nature of the discipline and objectives of the programmes posed additional challenges. The complex dynamics that emerged call for a critical examination of both, the facilitative dimensions that provide insights into online pedagogy for future educators, as well as limitations that circumscribe the online mode of learning. In this context, this paper builds upon narratives emerging from the responses of students pursuing post graduate degrees in Education, and Early Childhood Care and Education.

The two postgraduate academic programmes on "Education" and "Early Childhood Care and Education" (ECCE) aim to bring together elements of liberal and professional preparation of educators

and endeavour to make possible a study of education both as a social phenomenon and an area of knowledge, while developing the skills needed for professional practice. The programmes have intense field-based components at both school and non-school educational and early childhood care sites. These field immersion opportunities aim at providing a space to the graduates to engage with critical debates in education as they examine the field realities and understand the contexts of education. Many graduates eventually work as teachers, teacher educators, curriculum developers, researchers, consultants and professionals in government and non-government organisations. Further there are core and elective courses like Research Methods, Self-Development, Experience of Education, Inclusion of Young Children with Disability, Understanding Children and Childhoods, Educational and Organizational Leadership, Instructions in Middle and Secondary School Mathematics and Geometry, and others, whose pedagogic imagination involves workshop components, field visits, group activities and regular discussions on various concepts by drawing on experiences to make connections, reflect and review. The online transition thus had implications for the nature of exposure to the field sites and the classroom engagements.

e-Learning during COVID-19

We are living through what Castells (1996) refers to as the “information age”, marked by a movement of information through networks that he expected to overtake the circulation of goods as the primary source of value in society. Beetham and Sharpe (2007, p. 4) argue that some of the social and cultural reorganisation that Castells predicted can already be traced in the ways that the contexts of education are changing:

“Epistemologically, for example, what counts as useful knowledge is increasingly biased towards what can be represented in digital form. Many scientific and research enterprises now depend on data being

shared in the almost instantaneous fashion enabled by the Internet... less thought has been given to the knowledge that is forgotten or lost in the process of digitization: practical skills, know-how that is deeply embedded in the context of use, and other tacit knowledge associated with habits of practice”

This kind of tacit knowledge that is drawn on by effective teachers, and by effective learners is what many perceive to be rendered difficult to actualise as the world transitioned to an emergency remote form of learning. Overall, acceptance of digitally enhanced learning and teaching in higher education has grown over recent years, particularly in the Western European context. However, even in such contexts many institutions are still in the process of developing a more systematic and strategic way of digital integration. An International Association of Universities (IAU 2020) report indicates that despite having online repositories for educational materials, and institutional infrastructure for digitally enhanced learning and teaching in place, as well as digital skills training for staff and students, universities, even in the European context found the transition to online education during the pandemic challenging (IAU 2020, p. 10).

A point has often been frequently made that what has been provided in the context of the pandemic is not simply distance learning, but emergency remote provision. But this crisis is also posited by some as “a historic opportunity to make a major leap in terms of digital take-up, as well as a general transformation of learning and teaching. This euphoria needs to be reviewed with caution as experiences from across the globe attest to how this disruption led to adversely affecting student experience of learning remotely (Peters and Rizvi et. al., 2020).

In the Indian context, some of the key factors impacting this transition include the availability of technical infrastructure, accessibility of the institute, capacity building of teachers, and distance learning competencies, including the availability of devices and network with students



(Mittal, 2020, IAU Report). Mittal (2020) points towards how the government and institutions will need to invest heavily in technical infrastructure to enable the shift from conventional to a blended education model post-COVID. Learning assessment and examination approaches will also need to be reviewed in order to comply with online teaching and learning pedagogy. High quality Open Source Educational learning resources in various Indian languages will need to be developed, especially in subjects requiring practical skills and the development and training of staff and faculty for online teaching and learning pedagogy through extensive capacity-building programs. Given the scale of the higher education system in India, the projected tasks themselves require almost a transformative project of re-hauling the system and configuring new ways of quality assurance.

Several survey-based researches during this time brought out the stark inequity in access to online modes (NIEPA 2020, as cited in Sharma, 2020). A NIEPA report on the impact of COVID-19 on higher education in India, published in July 2020, suggests that online lessons are inaccessible to nearly 90 lakh students, nearly 65 per cent, enrolled in government colleges in India. The prime reason, according to the report, is unavailability of electricity, smartphones, laptops and internet. The findings are based on a ground survey conducted across 419 government and private institutes, from where 543 responses were received. The Report suggests that the inability to access online lessons will shrink overall enrollment in higher education institutes in India by 60 lakh students, from 3.7 crores to 3.1 crores.

Apart from the infrastructural dimension of the process of change, the experience across the globe has highlighted the need for centering the student voice and experiences in order to draw some essential lessons and build institutional resilience in the face of future crises. Peters, Rizvi, et al. (2020, p.2) posit critical questions for educators: “how might we rethink the basic purposes of

education, and the pedagogic models better suited to the ever-present possibilities of insecurity, risk and relentless change?” They argue:

“Digital pedagogies are ... not neutral with respect to the kind of sociality they encourage. Since a core function of education has always been social and cultural formation, the question arises as to what kind of sociality is possible when students and their faculty only meet in the digital space...Also important...are the issues of inequalities of access and outcomes in the new pedagogic spaces, and how they might be mitigated”(p. 2).

An engagement with the changed dimensions induced within an emergency context of the pandemic can perhaps enable an exploration and identification of challenges and opportunities for the discipline of education in particular and the higher education sector in general in a post pandemic world. Even as researchers engage with questions on how useful online learning is and has been, it is important to remind ourselves of the complex context in which this online learning is being experienced by both students as well as the teachers. We argue that the experience of a space or a process is shaped by the meaning one makes of it, a meaning which is not simply dictated by the explicitly stated mission statements but emerges out of an interactive and mediated process. The paper explores this dimension from the perspective of students of education.

Methodology

This paper is situated within the interpretive paradigm and seeks to explore how students enrolled in postgraduate programmes in the disciplines of Education and Early Childhood Care and Education, experienced and made sense of the online learning space during the pandemic. The sample of the study consisted of postgraduate students, pursuing MA Education and MA Early Childhood Care and Education (ECCE) at a

university in Delhi, who had shifted to online mode of teaching-learning in the beginning of April 2020. The data was collected in the form of (i) course feedback forms from students of four batches (particularly on online engagement) for eight taught courses; (ii) responses to an open-ended questionnaire administered to the same set of students for an in-depth exploration of their online learning experiences (15 responses were obtained); (iii) periodic group discussions and informal interactions conducted with each cohort of students over a period of nine months. A few of these interactions occurred during the online transactions of the courses taught by the researchers, when confronted with challenges like low or irregular attendance, limited participation on the part of students during class discussions. Some conversations took place during informal discussions around several academic and other concerns raised by students themselves. Since the researchers were also participant observers in the study, the insights emerging from the intersubjective spaces that were created during formal and informal teacher-student interactions, and researchers' reflexivity also contributed to the triangulation of the data.

Data analysis and discussion

In mid-March 2020, the government of the National Capital Region of Delhi, India decided to close the schools, colleges and universities for a period of two weeks in the light of increasing incidences of COVID-19 in the region. While initially it was planned as a two-week break, it became very long as the Government of India announced a nationwide lockdown during this period. This necessitated a sudden shift to the online mode given the uncertainty around the schedule of lifting of lockdown and opening of campus spaces. It was in early April 2020 that the university formally decided to shift teaching to the online space and the academic calendars were revised to accommodate this shift. Till this time, the teaching in our department had been

majorly in face-to-face mode with only a few of us using learning management system (LMS) platforms like Google Classrooms and Moodle. The use of these platforms was limited to sharing of reading and other pedagogic materials with students, some discussion chains and for submission of assignments. The shift required all faculty irrespective of their familiarity, knowledge or competence in online pedagogy to begin reaching out to students for course completion through synchronous and asynchronous modes. Faculty members were expected to conduct synchronous online lectures using Google Meet or Zoom, and make available recorded lectures/PowerPoints with audio on platforms like Google Classrooms and Moodle. In some cases, the faculty also provided study material and a weblink to the recordings through WhatsApp groups. When this shift happened, there was little preparation or a clearly articulated plan of action. The IT cell along with the faculty members conceived over time the possibilities and limitations of various online meeting platforms during this process. Few orientation sessions conducted by the University brought to the fore the myriad challenges that teachers were facing during this transition. An unpreparedness, lack of expertise and 'learning while doing' on the part of teachers contributed to the context in which students across disciplines were to initially experience online learning. The lockdown continued for a couple of months and even though interstate borders and other essential services opened for the public, educational campuses continued to remain closed.

During the first phase of the lockdown, nearly one-third of the courses/semester was left for completion, which could only be finished by end of May. Graduating students completed their dissertations virtually, changing their research questions to adapt to data availability. Many students who were expected to do school-based observations had to resort to desk study and telephonic interviews. The beginning of the new semester in August 2020 was accompanied by a more



cogently articulated academic plan by the University. The realisation had hit home that the second wave may be followed by a third one and it was clear that schools and universities would continue to work in an online mode only. What seemed like a temporary arrangement and an emergent response during the first phase of the lockdown was now a more stable context in which both faculty members and students had to make sense of the teaching-learning experience. Some students wondered if it would be worthwhile to continue teaching-learning in an online mode when the explicit objectives and expectations with which they had joined the education programme would remain unfulfilled or partially fulfilled. The much sought-after NGO-based field immersion, which required students to travel outside Delhi and engage with the organisational context of the field was transformed into a task-based learning through assignment completion for the field site. Collaborative and group-learning, dynamics of organisational life, unpredictability of an unfamiliar environment—elements that added to the comprehensive exposure and learning for students from the practicum became acutely restricted experientially.

While new admissions were delayed, the first year students' progression to the second year was marked by a disappointment towards an unprecedented change in academic plan, and also some motivation to make most of the opportunities available through the online mode. For most students joining this programme, the important incentives were the emphasis on research and field engagement, a dialogic and collaborative approach to theory courses and the location of the programme in a social science university which regularly organises lectures, seminars, workshops and other forms of academic and co-curricular experiences. There were some who had left teaching or foregone teaching jobs after the completion of their B.Ed. or B.El. Ed degrees to join this course in a face-to-face mode for the promise of an intense academic experience. The 'non-voluntary'

nature of the transition to the online mode formed an important part of the context. This was quite unlike the experience that teachers and teachers educators have when they willingly participate in a self-chosen online programme for faculty professional development.

The experience of students was complex, diverse and evolving as regular online interactions outside the classroom/course context continued to provide critical feedback to the faculty members and informed their efforts. The experience of the classroom and students' engagement as it unfolded across the semester is discussed in greater detail below.

Challenges of online learning during the pandemic

Some of the key themes that emerged were around the challenges associated with the online learning amidst the pandemic. These challenges were of a diverse and often interconnected nature and were informed by the socio-economic contexts of the family, the effect of the pandemic on people's physical and psychosocial well-being and their means of livelihood, the very nature of the 'online' learning environment and the aspirations and expectations of the students from the programme.

Unequal access and inequitable availability of resources

One of the most pronounced challenges was the unequal access to the online space, especially for the already disadvantaged and marginalised. The current moment entailed a transition to remote learning in a context that the academic community had not chosen for itself. The educational institutions were expected to shift to teaching-learning online with a muted assumption that the infrastructure required for the transition was available with the institutions and students. A smooth online transition required that all students had exclusive access to a laptop, a desktop computer or a smartphone at home, there was internet connectivity of a

good bandwidth and an internet pack with adequate data.

While writing about her experience of online learning, one of the students termed it as “*divisive and discriminatory*”. Many students felt that a “*forced*” shift to online, privileged those with resources. Several students shared that either their families or they themselves had to borrow money to be able to buy a laptop for the online classes and this laptop had to be shared with siblings who were also attending classes. Hence, attending online classes continued to remain a challenge.

Many students from outside Delhi began returning to their homes once the interstate travel reopened as several universities had closed their hostels and paying for ‘paying guest accommodations’ for ‘online classes’ appeared an unnecessary expense. The return of students to their homes which were not only in urban, well-connected areas meant difficulty in access caused by poor internet connectivity. The issues in connecting synchronously to the online classes emerged as a key concern that also caused stress and anxiety in many. A student reported the experience of online learning as follows:

“Stressful, panic [inducing] due to bad connectivity resulting in late arrival of notifications of assignments and classes, the same reason [also] hampering in [meeting] assignment deadlines”

Another student shared the following experience:

“There’s connectivity issues and I have missed out several classes, plus [am] unable to access class recording.”

“...lots of internet issues and limited data. When we were asked to watch any video, I have to wait for weekends as we don’t have classes then and I can use my data to watch the videos.”

A focused engagement with online learning also required the students to have a dedicated space at home where they could attend the classes without any distractions. Not all students had the privilege of having

such a space and it posed challenges to their engagement. One of the students shared,

“I couldn’t speak a lot in class even when the teachers invited, as it would require me to unmute and there was noise at the back due to other members at home working.”

In several discussions with students, the absence of a dedicated space emerged as an important concern. A physical classroom allowed them the space where they came together as a collective in pursuit of a common goal. Even the spaces outside of classrooms—library, canteen, corridors, and courtyards added to a unique experience of the collegial life. However, home was a very different space where family members were occupied in different tasks which sometimes could be kept apart but on other occasions, they also came into conflict with one another.

The challenges due to inequitable availability of resources became more heightened amidst the pandemic, where the impact of the economic and health crisis was felt by most to some extent and definitely more on the already vulnerable. Several students had witnessed the loss of a family member’s job thereby necessitating that they also contribute to the family income by taking up tuitions or part time jobs. The need to purchase laptops, desktops or smartphones pushed many students to have to borrow or take up work. Several students also wrote to faculty inquiring if they could take a zero semester to be able to work. These negotiations became more difficult in absence of face-to-face interactions between the faculty members and the students.

Difficulties in learning engagement

Besides the challenges of unequal access, the nature of the online platform particularly in the discipline of education created different challenges in engagement. Several students shared that due to difficulties in participation in the online mode, learning became more didactic and hence less engaging. While many of these difficulties in participation were caused by insufficient



resources as discussed above, the nature of the online platform also contributed to it. In several discussions and feedback forms, students had shared that with home being a shared space, they often found it “difficult” or sometimes also “embarrassing” to unmute. When asked why they did not use the chat when not able to unmute, a student shared,

“When a professor urges everyone to unmute their mics and speak up by calling out students’ names, I am always worried about my background noise. And when I am typing out an answer in the chat box, someone who is able to unmute their mic speaks up and answers by the time I type out my entire sentence.”

Another student also shared that their thoughts got shaped as they talked, however the process of writing was different.

“When I am unable to unmute, I try to write, but it is a slower process as I am still thinking. By the time I finish typing, the moment I wanted to intervene is gone, the class has moved on.”

The excerpt above provides important insights into the relation between the processes of thinking, speaking and writing, and the role of peers or the teacher as “more able” mediators. In class discussions, often students develop their thoughts as they are speaking. The gaps or struggles in articulation are supported by the peer group or the teacher who may prompt or subtly guide to help the student reach the articulation. When one is physically distant from the teacher and the peer group, writing a thought as it develops, becomes a lonely exercise where a thought can be shared only when fully developed and written. There is little possibility of it being facilitated and by the time one completes the process of articulation, the class may have moved forward and hence the spontaneity of participation is also compromised. The discussion in the online mode where students cannot see each other and often respond by way of writing, there are also challenges in learning being an intersubjective, critical dialogic practice (Matusov, 2009) where the collective understanding is not a sum total of

the individual inputs, but rather is arrived at by reflecting on and building on each other’s interventions. In the context of a programme that has students aiming to become teachers or teacher educators, to learn about mediated learning and collaborative learning in the absence of experience of such pedagogy, there is always a likelihood of concepts remaining only abstract.

The theme also provides useful insights into the classroom as a space for a collective which is working towards shared goals through a collaborative, mutually facilitative process. Lave and Wenger’s (1991) conceptualisation of “community of practice” becomes relevant here as the imagination of a classroom goes beyond that of a didactic space to involve a sense of participation in a shared endeavour. It is through the process of social participation that the process and goals of learning assume meaning. According to Lave and Wenger (1991), “learners inevitably participate in communities of practitioners and that mastery of knowledge and skill requires newcomers to move toward full participation in the sociocultural practices of a community... the meaning of learning is configured through the process of becoming a full participant in a sociocultural practice” (p. 29). The online learning, as shared by the responses of the students, took away from them the ‘*sense of a collective*’ or of a ‘*shared experience*’.

Students further shared that the shift from seeing teachers and peers in the classroom to having to stare at computer screens, which were many a times blank as the video cameras had to be turned off to facilitate easy access for the ones having slow networks, impacted their interest in the class. The awkwardness of silences can occasionally be a useful pedagogic choice made by a teacher in a real time classroom to push students to think and break the silence through a question or a reflection. These silences assumed different meaning in the online context where students had options to drop out or shift their attention to something else. Students who had to attend

the classes through smartphones shared how they struggled with reading the text of the Powerpoint presentations and readings presented on screen share. This disrupted their engagement with both the shared text as well as the concept.

The porous nature of boundaries between home and work created at the time of the pandemic impacted engagement in more ways than distraction through noise. In a programme where nearly ninety per cent of the students pursuing the degree to become a teacher or a teacher educator are women, these porous boundaries were significant in shaping the learning space at home. These were adult women, many of whom had already worked at a full-time job, a few were married and most had an increased share of responsibilities at home. A student during one of the several informal conversations that were organised during the peak of the pandemic shared,

“At home, I am supposed to help, when I go to university then at that time nobody disturbs. I focus on class. Now that the classes are happening at home, I am expected to help even while attending classes.”

Another student shared that she was expected to cook and finish other responsibilities at home before she could sit in front of the laptop. The household chores had to be prioritised over the class work. She struggled with attending classes and submitting assignments in the absence of active support from teachers and peers which was more readily available when she came to the campus.

There were students whose parents were working in the health sector and other essential services and hence their responsibilities had increased at home in light of the nature of their parents' work. A student whose mother was a health sector worker shared how she had to spend a lot more time in ensuring cleaning and sanitisation of home and taking care of household responsibilities as her mother's working hours had also increased.

Another important challenge to students' engagement with learning was posed by the nature of several courses whose pedagogic imagination required more participation of students in the form of class discussions, preparing group projects, visits to school and non school educational sites and participation in activities and workshops. These courses in the programme align with the aim of the programme to encourage students to engage with the field (school and non school sites), the educational practices there and situate them in the larger historical, sociopolitical and cultural context. While filling the feedback form for the course titled: 'Experience of Education: Immersed Reflections', which aims to place experience at the centre of educational discourse through the discipline of educational psychology, a student shared the following:

“it took away the 'experience' from the course titled 'experience of education'. the course was completed successfully but compared to offline medium, it left much to be desired in terms of discussion, reflection, etc.”

The “missing out on experience” was a concern that emerged in the feedback across courses. Similar feedback was received for a course on research methods where students felt that the online classes were not as effective in providing a hands-on experience. In the offline mode, topics like development of research tools, collection and transcription of data, thematic analysis, etc., were usually covered in a workshop mode. There was active guidance from the faculty, who could walk around the class as students worked on the assigned tasks and discuss with them in case of any challenges.

“it is very challenging to conduct a course as practical as research methods totally in an online mode. So, obviously there were some challenges at the students' end”

“It was challenging to engage with a research course in an online modality.”

The shift of summer field attachment to online mode evoked strong and emotional responses from students who were looking



forward to engaging with the field and communities. The component of the field also connects with other theoretical courses like State Society and Education, Educational and Organisational Leadership and others, as it helps make the connection between concepts and practice. Shifting the field attachment to an online mode marked a shift from immersion and engagement with the context of the field to having to independently complete assigned tasks. A prolonged engagement with online mode in a context where social and physical contacts had become extremely restricted, also led to a fatigue in the later months.

Negotiations: How students coped and what helped in meeting the challenges

The challenges that students encountered were not merely brought to attention through the questionnaire or course feedback forms. The university-wide decision of faculty members to volunteer for creating support forums for students had a critical role to play in understanding students' experience and needs. The authors of this paper were part of one such team of volunteer teachers involved in holding conversations with students and reaching out to them through emails and telephonic communication. The silence in the classroom found a narrative around them as we explored and talked of random issues and day-to-day lived experiences in informal spaces. We found that students liked hanging around in these virtual meetings. Many students stayed quiet even here, responding sometimes only through 'chat' mode. But, one of the authors found that many students would approach and call her after the session concluded, opening up about their challenges at the domestic or academic front and share how they gathered the courage to call and reach out for support after the collective sharing sessions.

The process of continuous conversations and multi-layered feedback seems to have worked in enabling teachers to understand what was desirable and what was not; in which domain was improvisation needed,

and where explicit form of student support was required. Sometimes, opening up and sharing candidly our own reflections of the online teaching experience enabled students to share their experiences more vividly. Some of the key insights into how they negotiated the multiple challenges eventually provided the faculty with ways of adapting and improvising the online learning experience. Students shared that they found the online exchange more meaningful when sharing of ideas, views were encouraged through discussions during class time. Academic concepts that were discussed and not simply lectured on seemed to have been received more effectively. A more organised learning space was created where students were provided timely access to learning resources in a staggered and well-planned manner before the lectures helped in facilitating discussion-based learning. Having a visual scaffold during the lecture, in the form of a PowerPoint presentation, or concept-maps/diagrams, or online activities that involved active participation of students seemed to help them retain better attention during synchronous classes.

"...most meaningful interactions online have been when both the student and teacher forget they are sitting in front of a machine and realise that both are being listened to. But it also depends on the environment; developing interaction through machines is difficult.

When I stopped comparing it to the physical class experiences and just accepting this transition, I could find something meaningful."

Students coped with their online learning difficulties in varied ways. One student shared their experience as follows:

"...trying to re-frame [my] thoughts and focusing more on what my brain is able to process, setting short goals and becoming comfortable with not doing well academically (not in terms of grades alone, but actual learning), trying to stay consistent with short goals set in my dissertation class—because there is a mentor that I get to talk to every week, and the tasks are broken down into small doable steps

I listen to lectures more than one time to get my concepts clear. This thing wasn't possible in an offline mode.

Talking to my friends about the struggles of this online mode of learning helped me cope with it better as it made me realize that I was not the only one facing issues with it and that I had company."

A new sense of solidarity seemed to emerge in the context of collective struggle and effort to cope with the challenges embedded within the online context of learning during the pandemic. Students were able to empathise, as expressed in the responses to the questionnaire, with their peers and faculty members, collectively adapting and humanising the alienating Google Meet screen:

Some conversations where we talk openly about how we are all managing with the pandemic, helps me hear from my teachers and peers once in a while. Then staying in touch with one or two friends, by talking about the assignments and trying to help each other cope with deadlines etc., has been helpful. In general, a new group that came out of this period was the community of students who were protesting during this lockdown. I found immense comfort in talking to them about issues of social justice and trying to do what was in our reach with regards to the inaccessibility issues with online learning for marginalised students. But more than that, talking to another cohort and realising I am not alone in feeling lost and overwhelmed this semester, made me feel better.

I feel very disconnected and aloof...I have to continue my studies and do assignments and also have to do house chores since I am at home and with all this, I have to forget that I have something that we call 'peers'. I said I have to forget because if I try to connect to them, then their challenges just make me feel bad for them and helpless that I cannot help them...and that I am privileged that my family could afford borrowing money from someone when there are many students who can't even borrow that much amount of money and thinking of dropping out of college..."

The narratives shared above point towards a considered response of these students to the challenges faced by their peers and an astute self-awareness about the emotional work involved in listening and sharing of struggles—the struggle to come to terms with a very real “helplessness” in the face of challenges that cannot simply be heard out, and if not addressed, weighed heavily on students’ minds. Enabling a support system where this helplessness did not turn into despair required a sustained effort on the part of the faculty collective as well as the extended peer group.

“This time is difficult for all of us, and one needs to be mindful of it. I made sure to talk to my peers whenever I couldn't cope with lots of tasks and we also understood that it is difficult for our faculty too, so we try to finish our tasks as soon as we can. And for content thanks to technology and faculty we have all our content in Google classroom..."

What did students find useful in the online learning experience?

When students were asked about what they looked forward to the most and found useful in the online engagement, an interesting set of responses emerged. The dominant voice and the first response had usually been about the disenchantment with the blank screen and difficulty in concentrating. The second set of responses on the questionnaire as well as what emerged during our cohort-wise discussion with students was how online learning platforms had emerged as a critical space for social support that continued to nurture students as a collective and added to their sense of belonging:

“I look forward to interacting with my classmates and faculty... Looking at someone's face apart from my family members' and listening to other people's voices...these (online classes) were also the only platform where we came together to learn.”

As teachers, we found on several occasions that if we logged in to our class a few minutes early, students would be present and a discussion would already be going



on. On probing this aspect with students, we found that it was one way for students to simulate the real classroom experience where they would chat incessantly between two sessions and they reproduced it in the virtual context by joining the class 10–15 minutes prior to the teacher and using the non-teaching/non-teacher present time for social interaction with their classmates.

The experience of a lockdown itself had been unprecedented in terms of exacerbating fragile family dynamics—creating a new and intensive emotional context in which the crisis and fear of the pandemic was compounded by the complex domestic equations and family dynamics. Students, primarily women, experienced the gendered demands on their time at home, acutely highlighting how the campus provided a more congenial and supportive space to study without them being encumbered by domestic demands on their time. Within the new arrangement, class time, and availability of a predefined online learning schedule enabled students to seek normalcy and negotiate an academic routine in some form (however contrived):

“They [online classes] add some semblance of normalcy to the day—following a timetable, doing something according to a timetable and calendar.”

The learning space which a classroom offered in the university cannot be compared to this [online] medium...but, online learning has helped me to stay connected with academic work rather than completely shunning it [given the demands on my time at home]. There's no doubt that in these times, it is due to the online learning medium only that we are connected.”

Being able to connect to people and ideas outside the immediate environment, sounding out anxieties during informal discussions, and having a sense of productive engagement with work also seemed to have enabled students to cope with uncertain and chaotic external environments. Pedagogically, an interesting insight emerged about how a set of students felt that they benefited from the transition to online learning with the

possibility of going over recorded lectures and resources asynchronously:

“I get to reflect much more than I used to, giving time to myself to learn and process my understanding and doubts without any distractions. It is hard, but I eventually managed it”.

Another student added,

“I like the online mode as I am unable to concentrate when everyone is talking and discussing. I feel inhibited and anxious. At home, I can listen to the lecture quietly without pressure to have to speak or always contribute.”

The dimension of self-paced learning emerged and seemed to have been a new learning experience for students as well as teachers. The experience demonstrated the need for a more useful form of blended learning approach, or a flipped classroom. As a programme engaging with macro and micro context of school education and good practices, we had very little engagement with ICT in school education. The pandemic-induced unplanned transition to online pedagogy provided a default template of experimentation and trial for both teacher educators and future teachers/educators with digital learning integrated course design and online learning platforms. Initial conversations with the student cohort and amidst the faculty had clearly demonstrated a fair skepticism about effectiveness of the online engagement. Most of them saw it as a futile exercise and even argued for a zero semester with no teaching and assessment. Irrespective of the skepticism, the experience as it emerged, ended up providing insights to students about what they found could work and help them learn better given the circumstances.

“One positive aspect of this has been that if one were to have 5/5 level of structure in offline classes, in the online mode there is at least 2/5 structure which is better than none at all. Having online classes has helped to be able to have some grip on time during the day and has generally been somewhat better for mental health.”

While a few faculty members had consistently used Google Classroom/ Institutional LMS as a digital repository of learning materials for their courses, the student experience during the online transition highlights how the use of LMS could actually help in providing access to course materials in a more structured manner. Students found that having all the learning resources in one place (Google Classroom) is helpful in organising study materials.

The informal discussions with students also helped us (faculty members) realise that for many, the new form of engagement over the virtual classroom created a space to articulate their thoughts and share their observations in a manner in which they did not feel 'pressured'. These were the students who admissibly felt a lot of pressure to perform in the classroom in making it count as 'active' participation. Some students felt that they were better able to focus on the teacher's voice in the virtual classroom, and not be distracted by movement within the classroom.

Student absence from the online classroom would add to teacher anxiety about them missing out on learning. Follow up with these students, in several cases, showed that students were negotiating the new social context of 'work and learn from home', and in some cases managing the limited resources available at home (more than one family members sharing the one electronic device available) by actively choosing to not attend classes synchronously but referring to the recorded lectures made available on Google Classroom. Their absence during online classes therefore could not be simply constructed as lack of a learning engagement. However, it clearly emerged that online learning was leading to very diverse kinds of learning experiences for the participants which were circumscribed by the asymmetry of access. Missing out on the dynamic learning experience of synchronous classrooms was often not a choice but a compromise. This took away from the collective experience,

enabling some to become full participants, while others to remain at the periphery.

For many students, it was also a moment to place themselves in the larger context of the social core-periphery that emerged during the pandemic:

"In the learning context, the interactions during the field assessment have been really meaningful for me and the discussions on inequality and class-caste divide have intrigued me a lot. I keep thinking about how people from the disadvantaged backgrounds must be coping with the new lifestyle (in the pandemic) and I also feel that many of us have been living in a delusional and [privileged] world..."

As the response from one student cited above shows, students also used the learning from their courses to reflect on the larger scale of asymmetry and inequality in society and how despite its imperfections, learning had not stopped for them as it had for thousands of children enrolled in government schools in the country during the pandemic. The field engagement which required students to virtually engage with HGS schools in Jammu, Faridabad, Bhopal, Bhimtal, Varanasi and the FSP programme of SOS Village at Anangpur, also provided critical insights to students about how school teachers were negotiating with technology, and the new learning paradigm. Observing Zoom classes in these schools and discussing the lesson plans with school teachers enabled them to reflect on and compare their experiences. Students also offered suggestions on how to improve interaction and real-time engagement during online classes as the repository of their learning experiences evolved.

"It was not that engaging at first but sooner or later, we all got the hang of it and the faculty played an important role and made us feel comfortable with the online mode."

While we as teachers and students may have a "hang of it" now, as the student cited above has expressed, it is also an opportune moment to critically engage with how to weave in the key insights from the

emergency remote learning experience. This endeavour would require critically engaging with the possibilities of blended as well as significant limitations of the exclusively online learning experience, remaining cognisant of the inequitable socio-economic context of education.

Concluding remarks

The online teaching-learning began at a time when there were strict physical distancing norms restricting the possibilities of face-to-face interaction, or visit to libraries and schools. The participants did not voluntarily choose this mode for teaching or learning and it was done at a time when families were struggling with loss of jobs, health challenges in the light of COVID-19, and an unpredictable and distressing context. Academic programmes and courses that were not designed for online transaction and were perhaps not even fit for an online mode of engagement, requiring active student interaction and participation, had to be adapted to remote learning experience. This paper brought forth the experiential context of students' response to the abrupt transition to online teaching and learning. Student narratives point towards the emergent disruptions, discontinuities, and pedagogical dilemmas and open up a complex space that is constantly being negotiated in the pursuit of coping and adapting to the new "normal".

An emergency immersion into the online mode necessitated by the pandemic is now being seen as an opportunity for new kinds of digital education markets. Online remote learning seems to be emerging as a popular choice and panacea for long-standing problems of inequity in access to education. However, as the themes emerging from the experiences and narratives of the students in the paper show, rather than addressing neatly the problems of access, the online

modality comes with its own set of equity and access issues. In a university located in the National Capital Region and equipped with adequate IT infrastructure for faculty, it took an enormous amount of the faculty's time and effort in creating a congenial and facilitative space for students' transition to online learning. And it still seemed to have fallen short of enabling a sense of inclusion for all students. The design pushed some to the newly configured peripheries in the digital space. We also need to take into account a critical insight that emerged in the course of this research. As teachers who had engaged with this cohort of students for over two semesters in real classrooms and university spaces, we had a contextual and situated understanding of who our students were. We had developed a collective sense of whose absence we could interpret as unusual and therefore reach out, and whose silence in the classroom had to be read into or followed up on. The relationship with students which had developed over a year provided a facilitative space to engage meaningfully and empathetically with a diverse set of experiential contexts, and emotional responses of students.

As educators, we will need to critically revisit and engage afresh with the idea of "online" and ICT in education, drawing on the repository of experiences accumulated during the pandemic phase. What are we aiming to achieve through online lectures? Will students connect to the old questions / strategies in the new context? Preparation for emotional work and teacher well-being has been concertedly absent from institutional discourse. Limitations and possibilities of the digital classroom will have to be addressed and situated within the context of equity in access. As a community of practitioners, a sustained research and reflection on the nature of blended learning and curriculum design is required.

References

- BEETHAM, H. AND R. SHARPE. 2007. *Rethinking Pedagogy for a Digital Age: Designing and Delivering E-learning*. Routledge, London.
- CASTELLS, M. 1996. *The Rise of the Network Society*. Wiley-Blackwell, Sussex.
- INTERNATIONAL ASSOCIATION OF UNIVERSITIES. 2020. *Regional/National Perspectives on the Impact of COVID-19 on Higher Education*. IAU, Paris. Retrieved from https://www.iau-aiu.net/IMG/pdf/iau_covid-19_regional_perspectives_on_the_impact_of_covid-19_on_he_july_2020_.pdf
- LAVE, J. AND E. WENGER. 1991. *Situated Learning. Learning Peripheral Participation*. Cambridge University Press, New York.
- MATUSOV, E. 2009. *Journey into Dialogic Pedagogy*. Nova Science Publishers, Hauppauge, NY.
- Marinioni, G., Land, H. v., Jensen, T. (2020). *The impact of COVID-19 on higher education around the world: IAU-COVID 19 Global Impact Survey*. Paris: International Association of Universities (IAU). Retrieved from https://www.iau-aiu.net/IMG/pdf/iau_covid19_and_he_survey_report_final_may_2020.pdf
- PETERS, , FAZAL RIZVI, GARY McCULLOCH, PAUL GIBBS, RADHIKA GORUR, MOON HONG, YOONJUNG HWANG, LEW ZIPIN, MARIE BRENNAN, SUSAN ROBERTSON, JOHN QUAY, JUSTIN MALBON, DANILO TAGLIETTI, RONALD BARNETT, WANG CHENGBING, PETER McLAREN, RIMA APPLE, MARIANNA PAPASTEPHANOU, NICK BURBULES, LIZ JACKSON, PANKAJ JALOTE, MARY KALANTZIS, BILL COPE, ASLAM FATAAR, JAMES CONROY, GREG MISIASZEK, GERT BIESTA, PETAR JANDRIĆ, SUZANNE S. CHOO, MICHAEL APPLE, LYNDA STONE, ROB TIERNEY, MAREK TESAR, TINA BESLEY AND LAUREN MISIASZEK. 2020. Reimagining the New Pedagogical Possibilities for Universities Post-Covid-19. *Educational Philosophy and Theory*. DOI: 10.1080/00131857.2020.1777655
- Retrieved from - <https://theconversation.com/coronavirus-universities-are-shifting-classes-online-but-its-not-as-easy-as-it-sounds-133030>
- MITTAL, P. 2020. Impact of COVID-19 on Higher Education in India. In IAU (2020), pp. 18-21.
- SHARMA, K. 2020. 90 Lakh Govt College Students can't Access Online Lessons, Report States, Urges Aid. *The Print*. Retrieved from <https://theprint.in/india/education/90-lakh-govt-college-students-cant-access-online-lessons-report-states-urges-aid/469631/>

Dr. Sneh Bansal
principal.cce@cgc.edu.in
Harpreet Kaur
mail.harpreet.09@gmail.com

Perception of Inclusive School and Perceived Preparedness and Concerns among School Principals in Chandigarh, India

Abstract

School principals are the key participants in creating and transforming schools to meet the needs of children with disabilities. Their beliefs and attitudes towards the education of children with special needs in inclusive settings are key factors in implementing inclusive school programmes. The main aim of this study was to examine how inclusive education is perceived by the school principals of Chandigarh, India. What facilities and support are available in Chandigarh schools for children with disabilities? Besides, the study was undertaken to identify the major challenges viewed by the Chandigarh (Union Territory, India) government school principals that impede the implementation of inclusion. The data was collected from school principals through questionnaires, face-to-face interviews and observations. The results were analysed under four themes: understanding of the concept of inclusion and principal's contribution in making school inclusive for all, physical and support services in schools, in-service training of the regular teachers in inclusive education and challenges perceived by the principals in the education of disabled children in schools. The results indicated that although principals had a fairly good idea about inclusion, they did not perceive the schools were ready for inclusion of children with disabilities. Lack of infrastructure and materials resources, special educators and support services, non-cooperation from parents, large class size, and behaviour problems of children with disabilities were cited as the main concerns. The study reiterated the need for upgradation of physical facilities in the school campus, availability of equipment, materials, and teaching-learning resources as well as training of teachers and availability of services of special educators and other support services for the benefit of children with disabilities. The principals with clear vision and training in inclusive methodology will help to create an environment of acceptance, cooperation, innovation and foster creative solutions for the implementation of inclusive education.

Keywords: Inclusive Education, Children with disabilities, Perception, Support services, Challenges

Introduction

In the 21st century, education of children with special needs has been a part of a discourse of educators as there is a paradigm shift in the education system of these children, from 'segregated instruction' to 'integrated', and now from 'integrated' to 'inclusive education' which is reflected in the national level policies and programmes that have been initiated by the government of India for CWD. Various policies and programmes including Kothari Commission (1964–1966), The National Policy on Education, 1986, the centrally

sponsored scheme of Integrated Education for Disabled Children, 1974 and Plan of Action, 1992 laid emphasis on the education of children with disabilities in general schools. Intending to decentralise education, a national initiative called the District Primary Education Programme (DPEP) was launched in 1994 for the development of elementary education. In an attempt to universalise elementary education, a programme called Sarva Shiksha Abhiyan was brought up in the year 2001–2002. Also, the Ministry of Human Resource Development formulated a comprehensive action plan for including

children and youth with disabilities in education in the year 2005. To support the inclusive education initiative, the Right of Children to Free and Compulsory Education (RTE) Act, 2009 and RTE Amendment Act, 2012 provides for free and compulsory education to all children in the age of 6 to 14 years (till 18 years for CWD). Since India happens to be a signatory to the Convention on the Rights of Persons with Disabilities of the United Nations General Assembly, it made way for the Rights of Persons with Disability (RPWD) Act 2016 that came into effect on 28th December, 2016 in India. The passage of the RPWD (2016) pledges a rights-based approach and equity-oriented practices for all persons with disabilities. The Act emphasises adaptations and accommodations to be made in the teaching and learning processes and methods in a class and underscores the importance of inclusive education so that CWD enjoy their rights equally with others and live with dignity and self-esteem. Finally, SSA and RMSA, the two major programmes of the Government of India dealing with general education have been merged under a comprehensive scheme called the Samagra Shiksha (Ministry of Human Resource Development, 2018) to look at education for all children including children with special needs in a continuum from kindergarten to class XII. Internationally, India, as a signatory to Salamanca World Declaration of 1994, United Nations Convention on the Rights of Persons with Disabilities in 2007, Policy Guidelines on Inclusion in Education, (UNESCO, 2009) and 2030 agenda for Sustainable Development (Goal 4) have also impacted the educational services of children with disabilities attending regular schools.

Despite extensive legislations and commitment to make schools inclusive for all children, hardly any progress has been observed in improving the learning expectations from children, especially those with disabilities (McLeskey, J. & Waldron, 2015). This calls for significant changes in the way our school systems are organised and how teaching-learning is transacted across classrooms. School principals or

administrators could be the key participants and can play a momentous role in creating and transforming schools to meet the needs of children with disabilities. Their beliefs and attitudes towards the education of children with special needs in inclusive settings are key factors in implementing inclusive school programmes. Various researchers have tried to explore the perceived current knowledge and skills of principals globally regarding inclusive education (Bublitz, 2016; Choi, 2008; Dyal, Flynt & Bennett-Walker, 1996; Hofreiter, 2017; White, 2018). Gilada Avissar, Shunit Reiter & Yona Leyser (2003) argued that the severity of disability affects the perception of principals towards inclusion. Principals' age, level of education, and in-service training were found to be related to their views and practices regarding inclusion. However, a study by Ramirez (2006) points out that rather than experience or demographic factors, special education training had a positive effect on the attitude of school principals' for inclusion (Hofreiter, 2017; Roberts & Guerra, 2017; Williams, 2015). The study by Chandler (2015) indicated that having friends or relatives with a disability and special education experience are significant factors for favourable attitudes towards inclusion. Downing, Spencer and Cavallaro (2004) indicated the key activities in which principals should engage to support inclusive schools including belief in inclusion, enrichment opportunities for teachers, active parent involvement and individualisation of the core. Several researchers reported that untrained teacher educators with insufficient practicum experiences using inappropriate teaching-learning approaches, large class sizes and limited resources pose hurdles to effective implementation of inclusive education (Ahsan, Sharma & Deppeler, 2012; Grönlund, Lim & Larsson, 2010; Malik, 2011; Zwane & Malale, 2018). Globally, the literature on beliefs and perception of principals and teachers on providing educational services to children with disabilities in regular classrooms indicates that inadequate infrastructure, lack of professional training, lack of



additional support, prejudice, attitudes of teachers and principals towards children with disabilities are the major impediments (Markku, 2015; White, 2018; Williams, 2015). Neves et al. (2019) analysed the meanings of the document National Policy on Special Education in the Perspective of Inclusive Education (2008) and its relevance for the definition of directions for disabled students' schooling in Brazil in the last ten years. It was highlighted that the document is not free of contradictions despite its discourse in perspective giving us the illusion of eliminating educational exclusion. The historical roots of cultural beliefs and tradition that mark the constitution of a nation shackle the implementation of public policy regarding inclusion. Therefore, the forces of exclusion co-exist along with our efforts at inclusion causing tensions, misunderstandings and ambivalence that end up showing the segregating aspects that threaten human dignity.

In India, there is a paucity of research in this area. What becomes apparent from statistics is that children with disabilities in India are most likely to drop out after the fifth class and are least likely to transition to upper primary or secondary school or vocational education (Singal, 2016). Though widely discussed for the last three decades, inclusive education has been a difficult concept to implement. Cultural beliefs and intrinsic institutional obstacles hamper the education of children with disabilities. The majority of researchers (Bhatnagar & Das, 2014; Parasuram, 2006; Sharma, 2002; Yadav, Das, Sharma & Tiwari, 2015) identified large class sizes, poor infrastructure and financial limitations as the major challenges for successful implementation of inclusive practices and the barrier themes identified were lack of inclusive education policy, lack of differentiation in instruction, negative effect on achievement grades, lack of professional development of teachers, parental pressure, negative attitudes, and admission policy of the school. Singal (2008) through her study also echoed the same belief that school

heads were the key factors for providing access to children with disabilities in regular schools. Urgent reforms in teacher training programmes, knowledge about skills related to inclusion, inclusive classroom practices and curriculum adaptation are needed for social inclusion and meaningful participation of children with disabilities (David & Kuyini, 2017; Srivastava, A.de Boer, Pijl, 2017; Tiwari & Sharma, 2015). Bakhshi P., Babulal G.M., Trani J.F. (2017) showed concern regarding drop-out of these children at a much early stage of schooling than non-disabled children. An NCERT paper (2007) reflected that "In India, the concept of Inclusive Education has not yet been linked to a broader discussion of pedagogy and quality education. Any broad reform in education cannot be implemented without taking the inclusion of learners with SEN into consideration (p. 33)". The literature indicates the perception and attitude of general teachers towards inclusive education, however, there has been a dearth of studies in India regarding the understanding of inclusive education and the support that is required in schools from the school principals' perspectives. The research questions for this study included the following questions:

1. How do principals understand the term "inclusive school for all" and what is their contribution to making school inclusive for all?
2. What are the physical facilities and support available in their school for the education of children with disabilities?
3. What type of in-service training is provided to train teachers in inclusive education?
4. What are the major challenges faced by them in making school inclusive for children with disabilities?

Methodology

To fulfill the objectives of the study, it was necessary to select a sample of an inclusive school where children with special needs were enrolled. The principals from the government

schools for this study were selected through purposeful sampling. Chandigarh has a good network of 114 government schools organised in 20 clusters with a total of 4,087 children with disabilities enrolled in schools. Barring a few, all schools are composite, covering grades I to X/XII (Department of Education, Chandigarh Administration). Ten clusters were selected purposively and thirty principals from the selected thirty government schools were included to examine how inclusive education is perceived. The authors adhered to the ethics of research, and data was collected after getting written consent. In order to understand their opinion about inclusive education, face-to-face interviews were conducted using a semi-structured questionnaire. It comprised of three main questions: (a) concept of inclusive education and Contribution of the school for implementing inclusion; (b) physical facilities and resources for Children with Disabilities in schools and (c) challenges in implementing inclusive education. Observations were also done by the researchers to verify the responses given by the school principal wherever possible.

Table 1: Enrollment of Children with Disabilities in Selected Schools

School	Total Enrolment	No. of CWD Enrolled	Percentage of CWD
	734	10	1.36
	1200	33	2.75
	2500	43	1.72
	2027	28	1.38
	2056	18	0.87
	1160	33	2.84
	1103	45	4.07
	2313	49	2.1
	1200	20	1.66
	1307	25	1.91
	621	18	2.89

	1161	18	1.55
	809	19	2.34
	343	12	3.49
	1225	14	1.14
	524	17	3.24
	1830	21	1.14
	863	40	4.63
	2027	52	2.56
	850	20	2.35
	1566	27	1.72
	1557	51	3.27
	818	24	2.93
	1428	29	2.03
	1000	5	0.5
	831	19	2.28
	2000	17	0.85
	1067	17	1.59
	2021	56	1.90
	1234	46	2.77

Table 2: Percentage of Enrollment of CWD in Selected Schools

Percentage of Enrolment of CWD	No. of schools
Enrolment of CWD between 0-1%	03
Enrolment of CWD between 1-2%	11
Enrolment of CWD > 2%	16

The enrollment data of children with disabilities along with the percentage of children with disabilities in thirty selected government schools are presented in Tables 1 and 2. According to census 2011, the total population of India is 121 Cr, out of which 2.68 Cr is disabled (2.21 per cent). An analysis of census 2011 data of children with disabilities enrolled in schools of Chandigarh revealed that around 2,14,227 children (between the

5–19 years of age) were attending school, of which 3,517 were disabled. The enrollment of children with disabilities in schools in Chandigarh is similar to the national level and comes out to be 1.64 per cent. The enrollment data of selected schools reveals that three schools had an enrolment of less than 1 per cent, eleven schools had enrolment between 1–2% and around sixteen schools had enrolment percentage greater than 2 per cent. The initiatives of Government of India like the RTE Act and 'Zero rejection' policy under SSA, ensuring that no child is refused admission on any grounds, seems to be working as far as access to educational institutes and admission of children with disabilities in regular schools is concerned. However, the mere presence of children with a disability does not ensure their “inclusion” and participation in class. There is a need to extensively examine the readiness of the schools concerning inclusive education and the major factors contributing to or impeding the inclusive education.

Table 3: Profile of Selected Government School Principals (N=30)

Demographic Variables		Frequency	Percentage of Respondents
Gender	Male	8	26.6
	Female	22	73.3
Training in inclusive education	Yes	4	13.3
	No	26	86.6
Educational qualifications	MSc. /M.A. and Bachelor in Education	22	73.3
	B.A. /B.Sc. with Bachelor in Education	6	20
	JBT with Bachelor in Education	2	6.6
Location of the school	Rural	12	40
	Urban	18	60

Type of school	Government Model High School (GMHS)	13	43
	Government Model Senior Secondary School (GMSSS)	17	57

The profile of the government school principals has been tabulated in Table 3. Of these participants, twenty-two principals (73.3 per cent) were female and eight (26.6 per cent) were male principals. Analysis of the data indicated that only four (13.3 per cent) had received training in inclusive education and twenty-six (86.6 per cent) said they have not received any training in inclusive education for children with disabilities. Besides, the educational qualifications of school principals are also varied, twenty – two (73.3 per cent) school principals were post-graduate in humanities or science with a bachelor in education, six (20 per cent) were graduate in humanities or science with a bachelor in education and two (6.6 per cent) of the principals had completed JBT (junior basic training) along with bachelor in education. Twelve (40 per cent) worked in schools located in a rural area and eighteen (60 per cent) worked in an urban area. Thirteen (43 per cent) of the principals worked in government model high school (schools up to Class X) and seventeen (57 per cent) of the principals worked in government model senior secondary schools (schools up to Class XII).

Results

Understanding of the concept of an inclusive school for all and their contribution to make school inclusive for all

On being asked about the concept of inclusive education, different views were collected from the principals. From the collected data, it has been found that the majority of the principals reported that Inclusion is

- enrolling all children into school without any discrimination
- a system under which children with disabilities are admitted in a regular school and taught under one roof
- a system of education for all
- including disabled kids in a regular school and bring them into the mainstream
- giving equal educational opportunity to all irrespective of their disabilities.

After being asked about their contribution to making school inclusive for all, the majority of the school principals followed the directions given by the Chandigarh Education Department which includes not denying admission to any child. Surprisingly, principals from rural areas were more concerned about the education of children with disabilities.

In a discussion with the school principal from a rural area, she stated:

“We introduced meditation and yoga classes for all children and special attention was given to children with disabilities so that they can take part in these classes. Special counseling sessions for children with special needs and their parents are arranged as they are from a low socio-economic status and are labour class.”

In this regard, one school principal narrated:

“I have arranged classes for children with disabilities on the ground floor and smart classrooms have been developed with audio-visual aids for them. It is always personally ensured that the resource teacher works in collaboration with the regular teachers to educate them.”

In another school, the principal explained:

“All the children with disabilities are treated and taught equally with their peer group. Children with disabilities are inspired and motivated by sharing motivational stories and video clippings. A bias-free environment is created in school. Teachers are motivated to attend training programmes on inclusive education and parents are motivated to enroll children with disabilities in school.”

It is clear from Table 3 that only 4 principals out of the total 30 received any kind of training in special needs. The principals discussed that there was no training program specially designed for school principals and most of them had no clue how to go about addressing the needs of children with disabilities along with other children in school. Whatever they were doing was their own initiative, based on their understanding of the concept of inclusion. There are no clear-cut guidelines regarding steps to be undertaken, policies to be devised or structures to be created within the school to support inclusion. Each principal had to devise their own ways of dealing with the situation. While reviewing school documents, it was observed that there was no effort on the part of the principal to plan for a school-wide programme to integrate children with disabilities. None of the principals interviewed could show any document related to a quarterly or annual planning for parent interactions, sensitisation sessions for students and teachers, neither did they bother to develop any guidelines for teachers or students with respect to children with disabilities. Most of these initiatives were intermittent and aimed at fulfilling the departmental compliance needs.

Although most principals exhibited a positive attitude of acceptance and took steps to ensure there were special toilets for children with special needs, they were seated in the same classroom as other children; segregation, wherever it was seen, was for pull-out sessions with a special educator or counselor. Similarly, principals hardly took time to look at the curriculum adaptation needs or teaching strategies to be employed in the inclusive classrooms for the benefit of these children. There was a CWSN incharge in every school entrusted with the task of maintaining records of number and category of children with special needs in school and filing reports related to them to the department. We could also not find any record pertaining to performance of special children through which principals could track their progress or achievement. It was

largely left to the resource teacher or the visiting special educator.

Table 4: Units, Categories, and Themes regarding Principals' Understanding of Inclusive Schools and their Contributions to Make their Schools Inclusive for Children with Disabilities

Units	Categories	Themes
<p>Understanding the Term Inclusive School</p> <hr/> <p>School in which all types of students can take admission without any discrimination Enrolment of all children in the school without any discrimination An inclusive school is a school which admits all types of children despite differences (mental/ physical/social/ emotional) It means all students are welcome in school irrespective of differences they have. All have equal rights and opportunities.</p> <hr/> <p>Education for all even for those who were not able to get it earlier. It helps society and such children to be in the mainstream with the help of education. It means school is for all Inclusive school for all in which all types of children are enrolled and study in a regular classroom and regular school. Inclusive school for all in which children with special needs study with normal students in normal class and normal school. CWSN students will study with regular ones A school in which all students study together irrespective of gender, caste, creed, disability CWSN should be taught along with normal children.</p>	<p>Admission without any discrimination</p> <p>Education of CWSN into a normal classroom with normal kids</p>	<p>Admission policy based on non-discrimination; every child has an opportunity to study in a normal school</p> <p>Children with disabilities study together with their peer group (non-disabled children), education is provided keeping in view the individual differences</p>
<p>Contribution in Making School Inclusive for Children with Disabilities</p> <ul style="list-style-type: none"> • Training is given to all teachers to enhance their knowledge and interest • Sensitisation programme • Awareness programme with parents • Special resource room • Provision of ramps and special toilets • Learning corner • Classrooms at ground level <hr/> <p>Work on activities of daily living skills Counseling of students Separate syllabus Vocational subjects Need-based assessments/preparation of separate question papers Audio-visual aids</p>	<p>Training to teachers, parents and special educator</p> <p>Physical facilities in school</p> <p>Changes in the daily schedule, method, and assessments were made to provide education to children with disabilities</p>	<p>Awareness and sensitisation programme for the staff members and parents are conducted to make school inclusive for children with disabilities Infrastructural facilities are arranged in schools for children with disabilities. Adaptation and Modification in curriculum</p>

Physical Infrastructure, teaching-learning Facilities and human resources

According to Mitchell (2015), “physical access ensures that all the elements of the indoor physical environment that may affect students' ability to learn are optimal.” Most schools in Chandigarh do not have appropriate physical infrastructure and teaching-learning facilities that meet the needs of all types of disabilities. The observations by the researchers in our study along with the responses analysed from the questionnaire filled by the principals regarding infrastructure and teaching-learning facilities available in schools reflected that in 60 per cent schools ramps were available, 53 per cent had modified furniture, 56 per cent had proper signage and 60 per cent schools had special toilets. Additionally, 60 per cent of schools had a resource room, 76 per cent had audio-visual aids, 16 per cent used a speech-to-text and text-to-speech software and only 13 per cent schools had screen reading software. For children with visual and hearing impairment, such types of teaching-learning materials are essential for meaningful participation in class. It was also observed that the schools do not have teaching-learning facilities as per the proportion of the number of children with disabilities enrolled in the schools. Though the Minister of State for Urban Development, Government of India has provided a practical framework in the form of a document titled Harmonized Guidelines and Space Standards for Barrier-Free Built Environment for Persons with Disability and Elderly Persons 2015 or Barrier-Free Designs with universal access, responding to the varying needs of the persons with disabilities, even then the schools don't have basic infrastructure to facilitate access. The observations and the responses by the principals indicate that the government schools in Chandigarh, India, did not have teaching-learning resources to support the learning of children with disabilities. As far as human support is concerned, in government

schools of Chandigarh, 83 per cent of the school principals responded that they have special educators, while only 36 per cent and 23 per cent of schools provided services of a speech therapist and occupational therapist respectively to children with disabilities.

Table 5: Responses of the School Principals on Facilities Available in Schools Concerning Physical Infrastructure, Teaching-learning Resources and Human Support

S. No.	Support in Schools	Appropriate (number of schools with %age)	In-appropriate (number of schools with %age)
I	Physical Infrastructure		
a	Ramps	18 (60%)	12 (14%)
b	Furniture according to needs of CWSN	16 (53%)	14 (46%)
c	Signage/ directions to negotiate the campus	17 (56%)	13 (44%)
d	Special toilets	18 (60%)	12 (14%)
II	Teaching-learning Resources		
a	Resource room	18 (60%)	12 (14%)
b	Audiovisual aids	23 (76%)	7 (23%)
c	Speech to text & text to speech software	5 (16%)	25 (84%)
d	Screen reading software	4 (13%)	26 (87%)
III	Human Resources/ Support for CWSN		
a	Special educator	25 (83%)	5 (16%)
b	Speech therapist	11(36%)	19 (63%)
c	Occupational therapist	7(23%)	23 (76%)



The principals in our study indicated that the services of special educators remain a major concern. Although 25 schools reported availability of special educators, yet in most cases, these were only available on a part-time or visiting basis. Only 18 schools reported having a resource room but majority did not have a resource teacher. The services of specialists were also intermittently available through camps organised at the cluster level. All the neighbouring schools under that cluster had to send their children, in that particular disability, to the cluster school to avail the services although transport was provided in most cases or fare was reimbursed. The resource materials, modified laboratory equipment, ICT resources to supplement classwork, Braille equipment and printer, play equipment and specially designed swings were also not available in the schools. Either most schools did not encourage children with special needs to go to a playground or the laboratories, or such children required to take help of their peers. Quite a lot of special needs children in informal interactions could not recall the last time they visited the playground. The time table also did not reflect any regular period for games, computers and laboratory visits. Although only 18 schools had ramps, handrails and special toilets, two principals showed us the letters they had written to the department for sanction to construct ramps and toilets for children with disabilities and were awaiting approval.

The majority of school principals wanted full-time special educators and other support services. They said:

“Special educators are appointed by the Department of Education, Chandigarh. Every special educator is appointed for a cluster, in which they cover around 6–7 schools. This indicates that there is no permanent special educator for one school. The special educator keeps moving from one school to another as per the schedule assigned by the Cluster Head. Due to the non-availability of special educators in one school, the educational programmes prepared for children with

disabilities are not being implemented effectively. As a result, they do not perform well in academics and often lag behind their peer groups. The services of speech and occupational therapists are not regularly available. The students get these services only during camps which are organised monthly, quarterly, or annually as per the cluster.”

In-service training of teachers in inclusive education

Principals were asked about how many regular teachers in their schools were trained in inclusive education and in what way. It was clear from their responses that every year department of education, Chandigarh conducts in-service training programme for the teachers and it is compulsory for at least two teachers from the school to register for the programme.

One of the principals spoke on the training of teachers in inclusive education:

“Every year, the department conducts professional development training programmes in inclusive education for subject teachers on intellectual disabilities, hearing impairment, visual impairment, autism, and so on. We send at least one teacher from the school. The training programmes are three to fifteen days long. Most of the teachers in my school have got training in inclusive education.”

From the interview, it has been found that although teachers attend training programmes of various durations (3-day, 5-day, 7-day, 10-day or 15-day) conducted by the Department of Education, yet the main concern is to ascertain how far they are equipped to teach children with disabilities in a normal classroom. It has been observed that there is a dire need for extensive training for teachers in inclusive education. The existing research in India also raises concerns on implementation (Bhatnagar & Das, 2013; Das, Kuyini & Desai, 2013).

The principals reported that although the teachers in their schools were attending training programmes in inclusive education

organised by the Department of Education, still most teachers were not confident in dealing with children with disabilities as most of such programmes were theoretical in nature and did not provide any real practical exposure in addressing the needs of children with special needs. They still struggled in classrooms trying to ascertain how to modify the curriculum to the needs of children under their care and how to strike a balance between teaching the rest of the class and individualise instruction to suit specific needs. Although a lot of commitment was visible on the part of the principals to help accommodate these children, the lack of basic training in inclusive education was a hindrance in developing a vision for an inclusive school set-up.

Challenges in Education of disabled children in schools

Principals of the school reported many challenges to make school inclusive with regard to CWSN. The majority of school principals reported that they need permanent resource teachers to teach these students and do not have appropriate infrastructure in their school as per the requirements of children. Moreover, the special educator in most schools visited once a week. In case of a holiday on the day of the scheduled visit, the subsequent visit would occur at a gap of 10–15 days. This resulted in a huge gap, and they would have to start afresh creating a further lag in learning. Since one special educator is catering to all the children of that disability in that school, sometimes children from neighbouring schools who fall in the same cluster also attend the class together—the class size may be as large as 80 children. This defeats the very purpose of providing personal attention and a small group interaction with the special educator.

A review of the records maintained by the special educator and the allocation of time table show that there was no time allotted to the special educator and class teacher for collaboration and planning educational programmes for children with special needs.

Observation and informal interactions with teachers in the staff room revealed that there was no ownership of the class teacher or subject teacher for the children with special needs. Though they would remain seated in the class, most teachers thought that the responsibility lay with the special educator alone. Very few teachers took the initiative to attend to them in class and carried forward the work assigned by the special educator. Principals held the view that children with special needs have various behavioural problems that are difficult to tackle and the same percentage of principals reported that mentally retarded and learning-disabled children were quite difficult to teach. The principals also reported that due to a huge class strength, the class teacher could not give individual attention to the special students. There is no technology in the school to teach them and they are not able to follow the same syllabus so there is a need to modify the curriculum for them.

Among other major problems stated by the school heads was a non-cooperation from parents of special children. The principals felt that being uneducated, daily wagers prevented such parents from understanding the problems faced by their children in basic reading and writing. They too, on their part, could not provide any kind of support at home but expected their children to perform like their peers at school. Some parents didn't attend parent-teacher meetings regularly—if the special educator suggested further tests, the parents would not be available for a follow-up. This became a hindrance in properly identifying the problem and getting a disability certificate for the child. The principals also added that that lack of parental counseling, non-availability of specialists, fewer awareness camps, etc., were some of the challenges which hindered the way to successful inclusion of children with special needs.

One principal said that *“the presence of CWSN in regular classrooms creates disturbance to other students while learning. Too much absenteeism and lack of parent*



cooperation make it difficult to teach such children in a regular school.”

It is clear that while school principals were making efforts in providing school education to children with disabilities, but due to the lack of training, the non-cooperative attitude of parents, lack of infrastructure and services of special educators and other professionals, it became difficult for them to make inclusive education successful. The lack of resources has been a major barrier in the implementation of inclusive education in India (Rotatori, et al., 2014).

Discussion

Understanding of the concept of inclusive school for all and principal's contribution to make school inclusive

Most principals were aware of the policies of the Government of India and were following them in their schools in terms of admission of children with disabilities in the school and non-discrimination on any grounds. Some of the principals were very concerned about the children with disabilities and were proactively working to integrate them with the mainstream. Sharma (2002) supported the view that principals showed initiative in making schools inclusive. Singal (2008) also reported that school heads were the main initiators in providing access to children with disabilities in regular schools. The principal of the school plays a significant role in defining school policy, vision and accepting culture in the school. The school principals expressed the desire for a special training programme aimed exclusively to address the needs of school heads that would equip them to create an inclusive set-up in their schools. In the absence of basic understanding of educational needs of children with disabilities and how best to serve them in regular schools, the principals were unable to devise any whole-school policies or programmes. The principal of the school has to show a commitment and have a vision for inclusion to work on the ground.

With the emphasis on competency-based education in NEP 2020 and focus on learning outcomes, the principals need to follow up on the progress of children with disabilities to prevent drop-outs and to ensure that the children are engaged in meaningful learning experiences in classrooms. This would also help in developing future plans regarding teacher training needs or providing remediation classes or adopting specific teaching strategies to support children who would either be lagging behind or facing learning difficulties. This can only happen if principals had the knowledge of inclusive pedagogy and expertise to support learning of students with disabilities and a firm belief that all children could learn if provided enabling environment and opportunities.

In terms of the contribution made by the school principal in making the school inclusive, the principals were proactively involved in upgrading the infrastructure of the school, arranging awareness sessions for parents and teachers about disabilities, modification, and adaptation of the curriculum to meet the needs of children with disabilities, teaching daily living skills and vocational skill training. There were still areas where they felt overwhelmed as there was lack of any comprehensive guidelines from the department. The paucity of proper equipment, resources and resource personnel thwarted their attempts at providing appropriate learning environment to these children.

The new policy initiatives of the government have brought children with disabilities in regular schools, a fact amply supported by rising enrollment numbers of children with disabilities. But without proper preparation and arrangements in place, these children will be deprived of meaningful educational experiences and may drop out. Singal (2008) also pointed out that simply allowing children to sit with their peers in regular schools will not result in “inclusion” unless effort is made to combat the exclusionary forces in play in the so-called “inclusive schools.” Thus, all possible support structures in

terms of physical infrastructure, equipment, teaching-learning material, curriculum support, trained and skilled human resource personnel must be provided for the successful implementation of inclusive education.

Physical Infrastructure, teaching-learning Facilities, and human resources

Most of the school principals reported that they did not have proper infrastructure and appropriate resources to meet the requirements of children with disabilities. There was a paucity of teaching-learning materials, ICT support and a lack of trained teachers, resource teachers and special educators. Most schools either did not have a special educator or one special educator was being shared by a group of schools falling in one cluster. The services of specialists like speech therapists and occupational therapists were available only in camps organized at the cluster level. The concerns expressed by principals find resonance in the work of other researchers in the field of special education (Bhatnagar & Das, 2014; Kundu, Bej & Rice, 2019; Sharma & Desai, 2002). All efforts to get children with disabilities into regular schools will be stymied in the absence of adequate material resources and a pool of dedicated trained human personnel. When children are already attending school, this scramble for putting together teaching-learning materials, arranging for teacher training, devising a curriculum for diverse needs of learners not only wastes the precious learning years of children with disabilities but also increases the likelihood of dropouts if they do not find classroom experience engaging enough. There is an urgent need to plug these loopholes if the various initiatives of the Government and recent legislations have to be put into practice successfully.

In-service training of teachers in inclusive education

The principals reported that they regularly send their teachers to attend in-service training programmes ranging from 3–15 days.

Since it is compulsory for a school to enroll at least two teachers to the training programmes that are arranged every year, most schools are sending teachers intermittently starting with the ones they can easily spare. Such training is not based on the needs of teachers but is generalised in nature; in most cases, it focusses on various disabilities instead of emphasis on inclusion, which should be the case. Although most principals stated that almost all their teachers have attended some form of training, how far this centralized, one-size-fits-all training is effective is doubtful. It emerged from interactions with principals that no effort was made by the department to understand the needs of the teachers, so what was such training targeted at? Instead of haphazard one time or block training, the department needs to have a continuous, structured, on-going professional development programme for teachers. Singal (2008) also pointed out that teachers did not regard themselves as equipped to address the needs of children with disabilities. Teachers are crucial to the successful integration of children with disabilities in the classroom by providing a stimulating and engaging social environment. Hence, the need for effective training of teachers cannot be overemphasised. Teachers not only need knowledge about disabilities but inclusive teaching methods and strategies to be employed to address the needs of a diverse group of learners in their classrooms (Srivastava, M., A. de Boer, A. & Pijl, S.J. 2017, Tiwari, Das & Sharma, 2015). Besides in-service training, an urgent need is also felt for undertaking reform of teacher education curriculum that should reflect the current needs of teachers who are having to deal with a great diversity of learners in their classroom like never before and extensive practical component in teaching in inclusive schools to be compulsory part of training.

Challenges in Education of disabled children in schools

Principals cited the lack of appropriate physical infrastructure, permanent resource



teacher, trained teachers, co-operation from parents, awareness, ICT resources, large class size, behaviour problems among children with disabilities, curriculum modification needs as major impediments to the inclusion of children with disabilities in schools. According to them, it was particularly difficult to teach children with intellectual impairment and those with learning disabilities along with other children. This was also highlighted by Singal (2008) that teachers were more accepting of children with physical and sensory disabilities (eg. visual impairment) as these children could be taught along with other children in a routine. This is indicative of the fact, that there is great resistance or skill deficient among the regular teachers to adopt their classroom instruction according to the needs of learners. The lack of specialists and support structures to the teachers further makes the situation tough for teachers. There have been many studies supporting the lack of resources, trained teachers, cultural beliefs, and systemic institutional barriers for failure in the implementation of inclusive education (Bhatnagar & Das, 2014; Kundu, Bej & Rice, 2019; Tiwari, Das & Sharma, 2015). Although there is now increasing awareness and acceptance of inclusion of children with disabilities, the dearth of resources and unmet training needs of teachers jeopardizes the successful implementation of inclusion of children with disabilities.

Conclusion

The successful implementation of inclusive education requires a paradigm shift in the way our school systems are organised. For a shift from “segregated” education to “inclusive” education fundamental reorganisation is required at all levels of school education starting from the philosophy and belief systems. It will take great effort for course correction for an education system that has been operating on performance at the year-end exam as the goal of education. It would require all stakeholders to critically analyse

their beliefs and realign with “education for all” in principle, that would require a rethinking as to how we can include all kinds of learners, how to take everyone along. The study aimed to examine how principals as heads of institutes perceive the concept of inclusion and how equipped they perceive their schools are to address the needs of children with disabilities.

The analyses of data collected from the study revealed that although school principals have a fairly good understanding of the concept of “inclusion”, most of them perceive their schools to be unprepared to establish an inclusive school for all. The results of the study provide valuable insights from the perspective of school principals in terms of understanding of the term “inclusion”, their efforts towards making their schools inclusive, the perceived concerns, and challenges in implementing inclusive education. The study reiterated the need for upgradation of physical facilities in the school campus, availability of equipment, materials, and teaching-learning resources as well as training of teachers and availability of services of special educators and other support services for the benefit of children with disabilities. The study also highlighted the need to review teacher training programmes with a focus on the needs of teachers, type of training, duration and the themes to be undertaken in such programmes. No doubt teachers are the key element in translating an inclusive curriculum in the classroom but in the absence of a clear cut inclusive policy and administrative support, even a teacher with the best of training will not be able to function with optimum efficiency. The principals with clear vision and training in inclusive methodology will help create an environment of acceptance, cooperation, innovation, and foster creative solutions for the implementation of inclusive education. India is still struggling with finding the best ways to promote the inclusion of children with disabilities in regular schools. Such innovative approaches seeped in our cultural ethos and methodologies will show us the

best way to move forward and may help us define “inclusion” in a better way.

authors, therefore, acknowledge the NCERT with thanks for their financial support.

Acknowledgments

This project was funded by the Division of Educational Research (DER), National Council of Educational Research and Training (NCERT), New Delhi under grant no. (F.No. 4-51 (668/DER/2014/330). The

Declaration of Conflicting Interests

The authors declared no potential conflicts of interest concerning the authorship and / or publication of this article.

References

- AHSAN, M.T., U. SHARMA AND J.M. DEPPELER. 2012. Challenges to Prepare Pre-service Teachers for Inclusive Education in Bangladesh: Beliefs of Higher Educational Institutional Heads. *Asia Pacific Journal of Education*. Vol. 32, No. 2. p. 241. Retrieved from <https://search.proquest.com/docview/1028099008?accountid=143932>
- BAKSHI P., G.M. BABULAL, J-F TRANI. 2017. Education of Children with Disabilities in New Delhi: When does Exclusion Occur? *PLoS ONE*. Vol. 12, No. 9. e0183885. <https://doi.org/10.1371/journal.pone.0183885>
- BHATNAGAR AND AJAY DAS. 2013. Nearly Two Decades after the Implementation of Persons with Disabilities Act: Concerns of Indian Teachers to Implement Inclusive Education. *International Journal of Special Education*. 28.
- BHATNAGAR, N. AND A. DAS. 2014. Regular School Teachers' Concerns and Perceived Barriers to Implement Inclusive Education in New Delhi, India. *International Journal of Instruction*. Vol. 7, No. 2. pp. 1308–1470.
- BUBLITZ, G. 2016. *Effective Strategies for District Leadership to Create Successful Inclusion Models: Special Education Directors and School Reform in the Context of Least Restrictive Environment*. Retrieved from ProQuest Dissertations & Theses Global. (1804049365).
- CHANDLER, T.L. 2015. *School Principal Attitudes Toward the Inclusion of Students with Disabilities*. Doctoral dissertation. Walden University, Minneapolis)
- CHOI, J. 2008. *Attitudes and Perceptions of South Korean Elementary School Principals toward the Inclusion of Students with Disabilities*. Available from ProQuest Central. (304606471).
- DAVID, R. AND A.B. KUYINI. 2017. Social Inclusion: Teachers as Facilitators in Peer Acceptance of Students with Disabilities in Regular Classrooms in Tamil Nadu, India. *International Journal of Special Education*. Vol. 27, No. 2.
- DOWNING, J.E., S. SPENCER AND C. CAVALLARO. 2004. The Development of an Inclusive Charter Elementary School: Lessons Learned. *Research and Practice for Persons with Severe Disabilities*. Vol. 29, No. 1. pp. 11–24.
- DYAL, A.B, S.W. FLYNT, D. BENNETT-WALKER. 1996. Schools and Inclusion: Principals' Perceptions. *The Clearing House*. Vol. 70, No. 2. pp. 32–35.
- GILADA AVISSAR, SHUNIT REITER AND YONA LEYSER. 2003. Principals' Views and Practices Regarding Inclusion: The Case of Israeli Elementary School Principals. *European Journal of Special Needs Education*. Vol. 18, No. 3. pp. 355–369. DOI: 10.1080/0885625032000120233
- GOVERNMENT OF INDIA. 2015. Disabled Persons in India: A Statistical Profile. Social Statistics Division Ministry of Statistics & Programme Implementation.
- GRÖNLUND, Å., N. LIM AND H. LARSSON. 2010. Effective Use of Assistive Technologies for Inclusive Education in Developing Countries: Issues and Challenges from Two Case Studies. *International Journal of Education and Development using Information and Communication Technology*. Vol. 6, No. 4. pp. 5–26. Retrieved from <https://search.proquest.com/docview/906340907?accountid=143932>

- HOFREITER, D. 2017. *Principal Preparation in Special Education: Building an Inclusive Culture* (Order No. 10285190). Available from ProQuest Central. (1928585729). Retrieved from <https://search.proquest.com/docview/1928585729?accountid=143932>
- KUNDU, A., T. BEJ AND M. RICE. 2019. Indian Educators' Perceptions of their Inclusion Implementation Practices in Secondary Schools. *British Journal of Special Education*. Vol. 46, No. 4. pp. 398–422. <https://doi.org/10.1111/1467-8578.12282>
- MALIK, G.B. 2011. Inclusive Education: Preparation of Teachers, Challenges in Classroom and Future Prospects. *Pakistan Journal of Education*. Vol. 28, No. 2. Retrieved from <https://search.proquest.com/docview/2364425746?accountid=143932>
- MARKKU, J. 2015. Inclusion, Integration, or What? A Comparative Study of the School Principals' Perceptions of Inclusive and Special Education in Finland and in Alberta, Canada. *Disability & Society*. Vol. 30, No. 1. pp. 59–72.
- MCLESKEY, J. AND N.L. WALDRON. 2015. Effective Leadership Makes Schools Truly Inclusive. *Phi Delta Kappan*. Vol. 96, No. 5. pp. 68–73. <https://doi.org/10.1177/0031721715569474>
- MINISTRY OF HUMAN RESOURCE DEVELOPMENT. 2018. Samagra Shiksha: An Integrated Scheme for School Education, Framework for Implementation. Retrieved from samagra.mhrd.gov.in
- MITCHELL, D. 2015. Inclusive Education is a Multi-faceted Concept. *Center for Educational Policy Studies Journal*. Vol. 5, No. 1. pp. 9–30.
- NATIONAL COUNCIL OF EDUCATIONAL RESEARCH AND TRAINING. 2007. Position Paper. National Focus Group on Work and Education. NCERT, New Delhi.
- National Policy on Education 1986, as modified in 1992 (1992): (New Delhi: Ministry of https://mhrd.gov.in/sites/upload_files/mhrd/files/upload_document/rte.pdf
- NEVES, L.R., M. RAHME AND CARLA MERCES DA ROCHA JATOBA FERREIRA. 2019. Special Education Policy and the Challenges of an Inclusive Perspective. *Educacao & Realidade*. Vol. 44, No. 1. doi:<http://dx.doi.org/10.1590/2175-623684853>
- PARASURAM, K. 2006. Variables that Affect Teacher's Attitudes towards Disability and Inclusive Education in Mumbai, India. *Disability & Society*. Vol. 21, No. 3. pp. 231– 242.
- RAMIREZ, R.C. 2006. Elementary Principals' Attitudes toward Inclusion of Students with Disabilities in the general education setting (Doctoral dissertation, Baylor University, 2006). ProQuest Digital Dissertations, (UMI No. 3216381).
- Rights of Persons with Disabilities Act. 2016. Gazette of India (Extra-Ordinary). Retrieved from <http://www.disabilityaffairs.gov.in/upload/uploadfiles/files/RPWD/ACT/2016.pdf>
- ROBERTS, M.B. AND GUERRA JR. 2017. Principals' Perceptions of their Knowledge in Special Education. *Current Issues in Education*. Vol. 20, No. 1. Retrieved from <http://cie.asu.edu/ojs/index.php/cieatasu/article/view/1567>
- ROTATORI, ANTHONY, BAKKEN, JEFFREY, OBIAKOR, FESTUS, BURKHARDT, SANDRA, SHARMA, UMESH. 2014. Special Education International Perspectives: Practices Across the Globe. Retrieved from <https://books.google.co.in/books?id=KgBmBAAQBAJ&pg=PA575&lpg=PA575&dq>
- SHARMA, U. AND I.P. DESAI. 2002. Measuring Concerns about Integrated Education in India. *Asia & Pacific Journal on Disability*. Vol. 5, No. 1. pp. 2–14.
- SINGAL, N. 2008. Working Towards Inclusion: Reflections from the Classroom. *Teacher and Teacher Education*. 24, 1516–1529.
- . 2016. Education of Children with Disabilities in India and Pakistan: Critical Analysis of Developments in the last 15 years. *Prospects*. 46, 171–183. DOI 10.1007/s11125-016-9383-4
- SRIVASTAVA, M., A. A. DE BOER AND S.J. PIJL. 2017. Preparing for the Inclusive Classroom: Changing Teacher's Attitudes and Knowledge. *Teacher Development*. DOI: 10.1080/13664530.2017.1279681
- The Right of Children to Free and Compulsory Education Act. 2009. Gazette of India (Extra-Ordinary). Available from https://mhrd.gov.in/sites/upload_files/mhrd/files/upload_document/rte.pdf

- TIWARI, A., A. DAS AND M. SHARMA. 2015. Inclusive Education a 'Rhetoric' or 'Reality'? Teachers' Perspectives and Beliefs. *Teaching and Teacher Education*. 52 (128 – 136).
- UNITED NATIONS EDUCATIONAL, SCIENTIFIC AND CULTURAL ORGANIZATION.
- WHITE, K.M. 2018. *Principals' Attitudes toward the Inclusion of Students with Disabilities in the General Education Classroom* (Order No. 10979200). Available from ProQuest Central. (2176903304). Retrieved from <https://search.proquest.com/docview/2176903304?accountid=143932>
- WILLIAMS, J.M. 2015. *Attitude and Perceptions of Public School Principals in Illinois toward Inclusion of Students with Disabilities in the General Education Classroom* (Order No. 3700733). Available from ProQuest Central. (1680274240). Retrieved from <https://search.proquest.com/docview/1680274240?accountid=143932>
- YADAV, M., A. DAS, S. SHARMA AND A. TIWARI. 2015. Understanding Teachers' Concerns about Inclusive Education. *Asia Pacific Education Review*. Vol. 16, No. 4. pp. 653–662. Retrieved from <https://doi.org/10.1007/s12564-015-9405-6>
- ZWANE, S.L. AND M.M. MALALE. 2018. Investigating Barriers Teachers Face in the Implementation of Inclusive Education in High Schools in Gege Branch, Swaziland. *African Journal of Disability*. 7. doi:<http://dx.doi.org/10.4102/ajod.v7i0.391>



Dr. Tattwamasi Paltasingh

tpaltasingh@gmail.com

Prakash Bhue

prakash.bhue@gmail.com

Child-centered Education in Indian Schools: Policies and the Practice

Abstract

Child-centered education has been a long-held dream for Indian schools. It has occupied an important place in formal schooling since the National Policy on Education -1986 was introduced. During the last few decades, several initiatives have been taken through the curriculum framework, teachers' training, and various plans and policies to make the teaching-learning process child-centered. But a large number of schools in India are yet to practice child-centered education. The National Education Policy-2020 has set a target of five years to develop the foundational learning and numeracy of the children by restructuring the pedagogy and teacher education. This paper is an attempt to highlight the barriers to implementing child-centered education in Indian schools and suggest an effective pedagogical approach for inclusive school education.

Keywords: Child-centered education, inclusion, policy, pedagogy, Indian schools

Introduction

Children are a valuable resource which impacts the future of the nation. Consequently, the nation must provide the necessary facilities and a conducive environment to fulfill their needs and to protect their rights. Through context-specific education, children can be prepared for the future. Realising this fact since independence, the Indian government has been striving to formulate various plans and policies to provide every child appropriate education in a safe and joyful environment. Over the last three decades, a large number of initiatives aimed at universalizing elementary education in India have been taken, and the country has attained significant growth in enrolment, retention, and infrastructure development. Between 2001 and 2011, the literacy rate has increased by 9.21 per cent from 64.83 per cent in 2001 to 74.04 per cent in 2011 (Census of India, 2011). But the quality of education remains a major concern. As per the findings of the Annual Status of Education Report (ASER, 2019), only 73 per cent of children who are enrolled in Class VIII can read Standard II level texts; this has largely stayed unchanged since

2016 (Pratham, 2019). Research reveals that unpleasant and bitter experiences at the school level have stopped children from actively participating in the teaching-learning process (Sharma and Kamath, 2015). In India, there is a predominant notion among teachers that students are like a blank slate upon which anything can be written. Teachers infuse the information and knowledge of what they want, and students, as passive learners, digest everything. Students learn things either from teachers or by reading the textbooks and learning moves from outside to the inside (from teachers to students) of the learner (Mishra and Singh, 2013). A power nexus is prevalent in the classroom situation. Teachers often exhibit their power over students and presume that they have complete mastery over knowledge which can enhance students' learning. But they forget that children cannot be taught and they can only be facilitated. There is a misconception among teachers that students only learn in the teaching-learning process and they have nothing to learn from them. Teachers have many things to learn from the students regarding pedagogies, classroom techniques, and so

on (Banerjee, 2015). To make the teaching-learning process interesting and learner-friendly, the Government of India (GoI) has focused on child-centred education for a long time. The National Policy on Education (NPE) 1986 has recommended adopting "a child-centred and activity-based process of learning" (MHRD, 1998, p. 14). The National Curriculum Framework 2005 appreciated the reform of curriculum to make education inclusive and meaningful experience of children and emphasised a child-centred pedagogy which gives predominance to "children's experiences, their voices, and active participation" (NCF, 2005, p. 13). In 2009, the GoI made education a fundamental right by introducing the Right of Children to Free and Compulsory Education Act (RTE, 2009). Considering the importance of children's learning the Act in Section 29 (2) has mentioned making learning interesting through activities, discovery, and exploration in a child-friendly and child-centred manner (Government of India, 2009, p. 10). But despite these decades of plans and policies, child-centred education in many Indian schools is yet to be practiced (Brinkmann, 2020). Long paragraph. Please split into three

Child-centred Education—Perspectives from Indian Thinkers

The importance of child-centred education is reflected in the educational philosophies of Rabindranath Tagore, Swami Vivekananda, Sri Aurobindo, and Mahatma Gandhi (Sriprakash, 2009). According to Swami Vivekananda, self-learning and self-actualized knowledge is real education. The main role of teachers is to encourage and motivate students to gain knowledge. He was against bookish learning and rote memory education (Vivekananda in Pal, 2019). Rabindranath Tagore also promoted child-centred pedagogy. According to him, "...For true education is to realize at every step how our training and knowledge have an organic connection with our surroundings" (Tagore

in Ferrer, 2018). Mentioning Sri Aurobindo and the Mother, Ferrer wrote that they were not contented with the teachers who had a negative attitude towards students and who include some alternative word??? education with compulsion. Children's delinquent behaviour could be changed through love and not through threat and punishment. They may be encouraged to reflect positive behavior.

Jiddu Krishnamurti is one of the greatest Indian educational philosophers of the 19th century who has immensely contributed to alternative education. Though he was not an educator in the formal sense, and he has not contributed directly towards child-centred education, his philosophy has relevance in contemporary society. J. Krishnamurti in his book *Education and the Significance of Life* (1953) has described the right education and the role of parents and teachers. In Chapter II (Right Kind of Education) he has talked about the meaning of true education which is to gain an understanding of oneself and make an individual 'complete' and capable of dealing with life as a whole. Contemporary education, which is based on the accumulation of information and knowledge from books and prepares students mainly to be competent for job markets, prepares the learners to be subservient, mechanical, and insensitive. A mind that has merely been trained is the continuation of the past and can never discover new things. The current school system trains students to learn some techniques which will enable them to earn future livelihoods. Krishnamurti stated that no method or system can bring the right kind of education as strict adherence to a particular method and leads to lethargy on the part of the teachers. Only love, care, and compassion can bring true education. Further, in Chapter IV (Parents and Teachers), he has mentioned that the problem does not lie with the child but instead with teachers and parents. The mistake that teachers commit is that they do not try to understand themselves or their relationship with the learners; they merely facilitate students to pass the examination



with the help of prototype knowledge. The idea is that children need to be guided and helped. If the teachers are themselves confused and stick to the taken-for-granted or prototype knowledge children cannot benefit (Krishnamurti, 1953).

Gijubhai Badheka, a pioneer in the field of primary education has immensely contributed to children's education. He has written several short stories, songs, rhymes, plays and newspaper articles placing the child at the centre of education. He believed that knowledge could be gained through games and co-curricular activities. Moving away from rote learning and examination-oriented teaching, he had encouraged children to explore and learn for self-development. Giju Bhai believed in the experiment and first-hand experience. According to him the real purpose of education is to enable and orient children in such a way so that they love their schools and teachers. If children are treated reverently with love and affection none of them will remain absent in schools (Jass, 2009). Child-centred education has been inbuilt and reflected in the contribution of many such Indian thinkers.

Challenges

Studies and reviews have revealed that teacher-centred education mainly promotes repetition, memorization and recitation (Barrett, 2007, Vavrus et al, 2011). This style of learning prohibits students from constructing their knowledge from the environment. As per the conventional practice in India, students are expected to be obedient and submissive towards their teachers. That is why students cannot raise their voice in many situations and consider teachers as their authorities. They simply receive what their teachers instruct and believe that as absolute knowledge. Teacher-centred education has made school education boring. Now efforts are being made to accommodate the needs of learners. The government has taken various initiatives to train teachers through in-service training

and orientation programmes to make classroom learning child-centred. Despite these initiatives, many Indian schools are not practising child-centred education. The National Education Policy (NEP) 2020 focuses on redesigning teacher education and early grade curriculum to develop foundational literacy and numeracy of the children (Government of India, 2020).

In developing countries like India, one of the main challenges in implementing educational policies and reform, is the lack of financial resources. The teaching-learning process requires infrastructures, training of teachers, teaching aids, etc., which require a huge amount of money with higher budget allocation. Implementing learner-centred education becomes a challenge for policymakers (Lall, 2011). In-depth studies on challenges in practising learner-centred education are required to bring out some possible solutions.

Lack of Infrastructure and Teaching Aids

Better infrastructure facilities can facilitate teachers to plan for activity-based and joyful learning. A study was conducted among in-service teachers of Odisha and Chhattisgarh to find out their experiences on various issues and challenges at the level of elementary schools. The majority of teachers of the study areas viewed that lack of infrastructure, teaching-learning materials and shortage of teachers are the key factors of lower learning achievement of the children (Pradhan, 2015). Despite several initiatives, a large number of Indian schools lack sufficient infrastructures like playgrounds, classrooms and teaching aids. At the primary level, the Pupil-Teacher Ratio (PTR) should be 30:1 whereas at the upper primary level it is 35:1. In many schools the number of students exceeds per classroom; some students are even asked to sit in the verandah and these students cannot concentrate and participate in the teaching-learning process. Teachers also cannot conduct any activities due to lack of sufficient space.

Attitude of Teachers

The teachers' world view and relationship with their students play a significant role in the teaching-learning process. Many teachers in India believe that the lower caste, poor and girl students are incapable of learning. They believe that the educational backwardness of parents prevents such students from receiving education at all. The main role of teachers is largely considered to be to pass on information without having ideas on how much the students have received or benefited. For some others, education is one of the important means of getting a good job. Teachers often control the students thinking that otherwise, they will be spoiled (Brinkmann, 2020). The hegemonic attitude of teachers as well as the educational administrators prevents them to adopt a learner-centred approach to education.

Activity-based Learning

The method of teaching in classrooms differs among teachers. For instance, the empirical study of Konantambigi (2013) revealed that for most of the teachers activity-based learning means singing and dancing. This is the idea of most of the school teachers in India. Parashar and Singh (2013) conducted a study in three eastern states—Jharkhand, Odisha and West Bengal to know the infrastructural facilities available for classroom transactions, strategies used by the teachers during teaching and the perception of students towards classroom transaction of science textbooks. The study has revealed that there were hardly any activities conducted for the teaching-learning process. Apart from this, in many Indian schools, some teachers are noticed to have introvert personalities and feel shy to face a large group, feel nervous and hesitate to speak. But true learning starts when teachers and students share their experiences without any fear. Hence personality of teachers and their ideas towards activities-based learning influence the learning process. For child-centred education, teachers need extra time for the preparation of teaching material

which is usually not availed by them because of the extra works (Mishra and Singh, 2013).

In rural and tribal areas in India, schools are generally set up in a pleasant atmosphere having the space to play. But in urban cities schools are located in congested areas without much scope for extra-curricular activities. Teachers have more scope to use play methods for teaching in rural and tribal areas (Konantambigi, 2013).

Language Issues

Language is one of the important elements of learning through which children communicate and think. Lack of language proficiency lowers the confidence of children which results in poor participation in classroom discussion. In India, the mother tongue is used by a majority of children but it has been largely ignored and not considered in the case of tribal children and linguistic minorities and others (Gandhi, 2014). Ramachandran and Naorem (2013) have asserted that language is one of the important forms of exclusion. A qualitative study was conducted by them in six Indian states of Andhra Pradesh, Assam, Bihar, Odisha, Madhya Pradesh and Rajasthan to assess the inclusion and exclusion aspects of schools. It was found that students from tribal districts and the western part of Odisha faced difficulties in learning because the teachers' language or official language of Odisha was different from the mother tongue of children.

Suggestions and Policy Implications

Rapid social change is witnessed across the globe and education is one of the appropriate mechanisms to cope with this fast-changing global environment. Thus, a new and context-specific approach to learning is essential. Education of the younger generation needs to be considered one of the topmost priorities for the holistic development of the nation. Child-centred education can be encouraged to enhance the learning ability of the children



and strengthen the foundation of learning. This learning is based on the constructivist approach which enables students to think about the problems from various perspectives and encourages them to construct their own knowledge (Agrahari, 2016).

Students' Feedback System

In India, teachers' performances are mainly evaluated based on the number of classes taken, the number of activities conducted, the number of responsibilities handled throughout their professional careers. But students' learning process, difficulties encountered during classes, challenges to comprehend the topics taught, etc. are largely ignored. Consequently, teachers do not consider teaching with seriousness and focus on non-academic activities. Through introducing a feedback system in the classroom teaching-learning can be enhanced. In this process, students can give their constructive feedbacks to the concerned teachers after the completion of the class. The feedback may involve the effectiveness of class, students' understanding, their difficulties in understanding, the effectiveness of teachers' teaching style and implications of learning.

Promotion of Indigenous Education

India is famous for the indigenous knowledge base practised by many native communities. During ancient times the relevance of indigenous knowledge was more prominent. The country's philosophers and intellectuals had already gained knowledge of astronomy, *Ayurveda*, architecture, water management and life skills (Bhatia, 2014). In India, rural and tribal communities possess unique knowledge of farming, environment, economy, medicine, architecture and so on which can be included in the current school curriculum to make the teaching-learning process more creative, context-specific and interesting. The pedagogical approach should be contextual and local.

Experiential Learning

In a classroom situation where the teacher delivers a lecture and students listen passively, teaching becomes uninteresting and monotonous thus, affecting the learning of the students. In this situation, children with special needs (CWSN) suffer a lot (Krishnaswami and Shankar, 2003 in Das et al., 2012). Through experiential learning, the teaching-learning process can be made interesting and joyful. Hence, the teachers should create an atmosphere where students will learn by doing activities, interacting with others, playing roles, etc. School education can be associated with the real world of the children so that they can equip themselves to use acquired knowledge in real life.

Mode of Assessment of the Learners

Assessment of the learners is mostly done by testing basic literacy and numerical skills which promotes rote learning and ignores a child's creativity and hidden potential. The Annual Status of Education Report (ASER) has been periodically publishing information on the classroom performance of children (Kumar, 2015). The Indian school system needs a paradigm shift from testing of Intelligence Quotient (IQ) to Emotional Quotient (EQ). The importance of emotional intelligence is deeply felt by educational psychologists. Emotional intelligence would enable children to cope with various situations, make wise decisions and control emotions when the situation demands (Srivastava, 2007). Consequently, the present curriculum can be restructured to incorporate contents by which children's EQ can be tested. Life skills can be added as a subject in the school curriculum.

Making the Classroom Interesting through Innovation

Listening is one of the important cognitive processes that require interest, energy and motivation and plays a vital role in the teaching-learning process, whereas hearing is a passive physiological activity which may

not require serious efforts (Sultana, 2016). Very often students are seen as passive and distracted in the lecture method of teaching. Through the help of creative pedagogy and teachers' innovative ideas, their listening skills can be developed. Considering the COVID-19 pandemic situation, technology can be used effectively for generating interest among students. These days numerous learning videos with diverse languages are available on YouTube. These videos can be used as learning material; teachers and students can be engaged in discussions at the end of the video. Through this method, the motivation of students can be enhanced and their thinking ability can be developed. Care should be taken to include all children in digital learning by bridging the digital divide.

Culturally Inclusive Pedagogy

The culture and experiences of teachers and students significantly affect the teaching-learning process (Rana and Culbreath, 2019). India is a land where we find diverse cultural groups who are distinct from each other in terms of belief, style of living, language, needs and so on. In India, tribal children come to schools with rich experiences and their attitudes, belief and values may differ from other groups. If teachers teach all students in the same manner throughout the country, certain groups may get excluded. A culturally inclusive pedagogy would be helpful where teachers are expected to know the cultures, perceptions, values and experiences of children (Gandhi, 2014).

Foundational Learning and Literacy

In India, over 5 crore children have not attained foundational literacy and numeracy that is, the ability to read and understand texts, solve basics of additions and subtractions (GoI, 2020). The current school system in India is planned by age and grade system. Elementary education starts from age six (Grade I) and ends at age fourteen (Grade VIII). However, as per the New Education Policy 2020, the foundational

learning is planned to continue for five years which is three years for pre-school education and two years for Standard I and Standard II (GoI, 2020). The difficulty level of the curriculum also increases according to the grade. Through continuous and comprehensive evaluation (CCE), children's performances are being measured and there is a no-detention policy at the primary level. Generally, in Indian classrooms, children sit in a row and listen to their teachers, which is a passive engagement. Children can be made to sit in a circle so that there will be effective communication among students and teachers. To develop basic literacy and numeracy skills, children should be shown diagrams and charts and be made to read them aloud so that their difficulties can be identified. Through group work, play method, and experiential learning, their numeracy, literacy skills, and creativity can be developed (Banerji and Chavan, 2016).

Internship Programme for Teachers

Teachers' knowledge and experiences in classroom management and pedagogical implications influence the teaching-learning process. They have an important role to play in a child's intellectual, moral, social and emotional development (Rajashree, 2019). To upgrade teachers' knowledge of child pedagogy, an internship programme can be initiated for the concerned subject teachers. Through this program, teachers would visit various educational institutions, research institutes and Non-Governmental Organisations (NGOs) who are working on innovative education and doing experiments to develop new teaching methodologies and teaching-learning materials.

Conclusion

Teachers play a vital role in implementing child-centred learning and inclusive education at the elementary level. Teachers' belief system, attitude, values, perception, interest and skills largely influence the classroom transaction as well as the learning of the students. Through appropriate teaching



methodology and effective pedagogical knowledge, they can facilitate students to achieve learning goals. They can also help the children to learn basic skills of life and shape their personalities desirably. Adoption of appropriate learning strategies and attitudes of the teachers play a significant role in the overall development of school children. The teacher must understand the relevance of child-centred education that has been encouraged in the country through various policy documents. They need to change

their mindsets and adapt their world view in a manner that they start to see the inner abilities of children. To achieve the targeted goals of developing child-centred learning, a culturally inclusive pedagogy is needed and training modules for teachers can be appropriately designed. The teacher can adopt cooperative learning, brainstorming, experiential learning and other effective approaches to teach students so that they can construct a world of learning.

References

- AGRAHARI, R. 2016. The Nature of Educational Reform and Change: From Teacher-centred to Student-centred Learning. *International Quest: An International Journal of Education and Applied Social Sciences*. Vol. 7, No. 2. pp. 133–139.
- BANERJEE, A. 2015. Exploring Potentialities in a Child. *Journal of Indian Education*. Vol. 41, No. 3. pp. 60–64.
- BANERJI, R. AND M. CHAVAN. 2016. Improving Literacy and Math Instruction at Scale in India's Primary Schools: The Case of Pratham's Read India Program. *Journal of Education Change*. 17: 453-474 DOI 10.1007/s10833-016-9285-5
- BARRETT, A. 2007. Beyond the Polarization of Pedagogy: Models of Classroom Practice in Tanzanian Primary School. *Comparative Education*. Vol. 43, No. 2. pp. 273–294.
- BHATIA, R.P. 2014. Traditional Knowledge System in India and their Relevance. *Journal of Indian Education*. Vol. 40, No. 2. pp. 58–69.
- BRINKMANN, S. 2020. The Invisible Barriers to India's Educational Reforms. *Economic and Political Weekly*. Vol. 25, No. 4. pp. 50–57.
- Census of India. 2011. Literacy Rate-Census of India. http://censusindia.gov.in/2011-prov-results/data_files/india/Final_PPT_2011_chapter6.pdf
- DAS, A.K., S. SHARMA, AND V.K. SINGH. 2012. Inclusive Education in India: A Paradigm Shift in Roles, Responsibilities, and Competencies of Regular School Teachers. *Journal of Indian Education*. Vol. 38, No. 3. pp. 79–83.
- FERRER, A. 2018. Ethics within a Spiritual/ Metaphysical World View. Towards Integral Value-based Education. The Sages of India: Vivekananda, Tagore and Aurobindo. *Ramon Llull Journal of Applied Ethics*. 9, 39-73. Retrieved from <https://search.proquest.com/docview/2229616565?pq-origsite=gscholar&fromopenview=true>
- GANDHI, M. 2014. Mother Tongue Education for Tribal Children. *Journal of Indian Education*. Vol. 40, No. 3. pp. 54–67.
- GOVERNMENT OF INDIA. 2009. The Right of Children to Free and Compulsory Education Act, 2005. Ministry of Law and Justice, GoI, New Delhi.
- . 2020. New Education Policy 2020. Ministry of Human Resource Development, Government of India.
- JASS, H. 2009. Giju Bhai Badheka: On being a Primary Teacher. *The Primary Teacher*. Retrieved from <https://nroer.gov.in/home/file/595f1ff216b51c7355bc1b93?selected=595f206216b51c7355bc1bb6>.
- KONANTAMBIGI, R.M. 2013. Play and Playway Method in Elementary Grades: Is it there? *Journal of Indian Education*. Vol. 38, No. 4. pp. 44–62.
- KRISHNAMURTI, J. 1953. *Education and the Significance of Life*. Krishnamurti Foundation of America.

- KUMAR, K. 2015. We Need a Real Learning Grid for India's Elementary Schools. *Hindustan Times*. <https://www.hindustantimes.com/ht-view/we-need-a-real-learning-grid-for-india-s-elementary-schools/story-qCMAOfeJhps1vXssHzhiGP.html>.
- LALL, M. 2011. Pushing the Child-centred Approach in Myanmar: The Role of Cross National Policy Networks and the Effects in the Classrooms. *Critical Studies in Education*. Vol. 52, No. 3. pp. 219–233.
- MINISTRY OF HUMAN RESOURCE DEVELOPMENT. 1998. National Policy on Education 1986 (As modified in 1992). Government of India, Department of Education, Ministry of Human Resource Development, New Delhi.
- MISHRA, S.K AND A. SINGH. 2013. Each Child can Construct Knowledge. *Journal of Indian Education*. Vol. 39, No. 3. pp. 72–77.
- NCF. 2005. National Curriculum Framework 2005. National Council of Educational Research and Training (NCERT), New Delhi.
- PAL, M. 2019. Education in the Vision of Swami Vivekananda. *Techno Learn: An International Journal of Educational Technology*. Vol. 9, No. 2. pp. 125–132.
- PARASHAR, R.K. AND V. SINGH. 2011. Strategies of Classroom Transaction of Science at Upper Primary Level in the Light of NCF-2005. *Journal of Indian Education*. Vol. 37, No. 1. pp. 54–63.
- PRADHAN, M. 2015. Low Learning Achievements of Children in Elementary Schools Tribal and Rural Pockets of Odisha: What do the Teachers Say? *Journal of Indian Education*. Vol. 41, No. 3. pp. 45–59.
- PRATHAM. 2019. Annual Status of Education Report (Rural), 2018. ASER Centre, New Delhi. Retrieved from <http://img.asercentre.org/docs/ASER%202018/Release%20Material/aserreport2018.pdf>
- RAJASHREE. 2019. Pre-service Teachers' Beliefs about Moral Aspects of Teaching. *Voices of Teachers and Teacher Educators*. Vol. 7, No. 2. pp. 50–58.
- RAMACHANDRAN, V. AND T. NAOREM. 2013. What it Means to be a Dalit or Tribal Child in our Schools: A Synthesis of a Six-state Qualitative Study. *Economic and Political Weekly*. Vol. 48, No. 44. pp. 43–52.
- C. 2019. Culturally Inclusive Pedagogies of Care: A Narrative Inquiry. *Journal of Pedagogy*. Vol. 10, No. 2. pp. 87–99.
- SHARMA, R.K. AND ASHA K.V.D. KAMATH. 2015. The Learning Environment in Schools: A Field Experience. *Journal of Indian Education*. Vol. 41, No. 3. pp. 34–44.
- SRIPRAKASH, A. 2009. Joyful Learning in Rural Indian Primary Schools: An Analysis of Social Control in the Context of Child-centred Discourses. *Compare: A Journal of Comparative and International Education*. Vol. 39, No. 5. pp. 629–641.
- SRIVASTAVA, N. 2007. A Study of Emotional Intelligence in Relation to Advisements in Environmental Studies. *Journal of Educational Studies*. Vol. 5, No. 1. pp. 7–9.
- SULTANA, Y. 2016. Effectiveness of Using Technology Supporting Materials for Developing Listening Skills among School Children. *Journal of Indian Education*. Vol. 42, No. 3. pp. 48–55.
- VAVRUS, F., M. THOMAS, AND L. BARTLETT. 2011. *Ensuring Quality by Attending: Learner-centred Pedagogy in Sub-Saharan Africa*. Fundamental of Teacher Education Development. Addis Ababa, UNESCO.

Prof. Jasim Ahmad
jahmad@jmi.ac.in
Meenal Arora
meenalar18@gmail.com

Green School Model: Best Practices from the Field on Education for Sustainability in India

Abstract

Today's education must respond to the new 2030 Agenda for Sustainable Development by preparing young generations to deal with challenges such as poverty, hunger, inequality, climate change, loss of biodiversity, and natural resource depletion, resulting in negative consequences on human health and livelihood. To achieve this, UNESCO has been promoting Education for Sustainable Development (ESD) since 1992. It led to the UN Decade for ESD from 2005 to 2014 and is now directing its efforts towards the Global Action Programme (GAP) on ESD. A Green School is a school that prioritizes energy, waste, water, food, and biodiversity management in its governance, teaching and learning practices, community partnerships and facilities and operations of the school. The purpose of a Green School is to help students understand our impact on the planet and how to address the colossal social, economic, and environmental problems that we face today. A Green School provides a dynamic and vibrant learning environment as it addresses real-life challenges by practising and modelling sustainability in all aspects. To achieve this, more and more schools are adopting initiatives on five major themes: energy, water, waste, food, and biodiversity, thus empowering various stakeholders to embark on the journey towards sustainable development. The study draws its result using both secondary as well as primary data collected through the tools developed by the researcher. The study is exploratory in nature and presents the analysis on a thematic framework highlighting the strategies that schools can easily adopt to become Green Schools.

Keywords: Green School, Education for Sustainability

Introduction

Sustainable development is considered a “fluid concept” (IISD, 2010, p. 6) as it has been interpreted in multiple ways. Most interpretations of the term can be classified as either “technological” or “ecological” (Orr, 1992). The technological approach emphasises reducing the adverse impact on the environment through technological advancements and new legal rules and regulations while following the same socio-economic growth trajectory. This technological approach is top-down in nature, as it is driven by experts in the fields of science, technology and law, instead of the local community. On the other hand, the ecological approach is bottom-up in nature, as it argues for social transformation by

incorporating both expert-driven science and technology-based knowledge as well as the efforts of the common citizen. The ecological approach thus requires collaborative efforts of both experts and people of the community. Presently, the technological approach is more widely accepted and valued, but there is dire need to shift our attention to the ecological approach which often goes unrecognised and underappreciated. To promote this, United Nations dedicated a decade of Education for Sustainable Development (DESD) from 2005–2014, which required “the concerns about sustainable development to be inculcated through education” and the efforts continue with the commitment of the nation towards “Global Action Programme” on ESD (UNESCO, 2005). This paper presents one such model of Green School, empowering young people

to take responsibility for the social, economic and environmental challenges that we face today. The researchers studied manuals, case studies and reports of five organisations working on green schools in India, and analysed the qualitative data based on the principles of framework analysis, to identify the best strategies on the themes of energy, food, water, waste, and biodiversity. Further using the 'whole school approach' and the themes identified, a thematic framework was prepared, and tools were developed for primary data collection from five Jawahar Navodaya Vidyalayas (JNVs) in the Delhi-NCR region. The results present a model that can be adopted in India to make green schools a reality in every aspect—Governance, Teaching and Learning, Community Partnerships & Facilities and Operations (UNESCO, 2016).

Themes Of A Green School

To identify the themes of the Green School, the researcher reviewed 19 most important resources which include books, activity manuals, guides, teacher handbooks, and other documents on green schools, eco-schools or sustainable schools from across the world. Based on the review, the following themes were identified as they were recurring the most.

Table 1: Recurrence of Themes in Literature on Green Schools

Themes	Recurrence (out of 19)	Percentage of Recurrence
Electricity	19	100
Waste	19	100
Biodiversity	18	95
Water	18	95
Food	12	63
Transport	12	63

Whole School Approach

More and more researchers are advocating the whole school approach to operationalise

ESD in schools, which hopes to reflect the microcosm of the sustainable society we wish to create. As the name suggests, the whole school approach implies, every aspect of the school culture works towards the goals of sustainability, through its concerted efforts—in governance, teaching and learning, community partnerships, and facilities and operations – and are habituated in the daily actions of managers, administrators, teachers, students, school helpers, and even parents. The principle of the whole school approach is based on Mahatma Gandhi's quote, "be the change you wish to see in the world." This approach helps in changing the culture of the school by practising what is being taught in the school, and thus students learn what is right and wrong by imbibing appropriate attitudes, values and skills. The whole school approach takes into account the following aspects:

1. *Governance:* The vision, mission, objectives and values that sum up a school reflect the specific history, culture and needs of the school and the local community. School governance is reflected in its strategic plans, policies, procedures, guidelines, budgets and in the work of the school committees.
2. *Teaching and Learning:* The philosophical underpinnings, content selected, pedagogical methods and approaches adopted and learning outcomes and their evaluation mechanism governs the teaching and teaching processes of a school.
3. *Community Partnerships:* Associations and partnerships developed by the school for the benefit of the students or the community which it serves.
4. *Facilities and Operations:* School facilities and operations are the systems that are engaging and active, to best harness the power of physical place—including the built environment, surrounding natural environment and the resources that flow through the school. (UNESCO, 2016b)

Operational Definition Of Green School

In this paper, the term Green school is operationally defined as a school that prioritises the following:

1. *Energy Management*: It includes the type of electricity and fuel consumption and its conservation.
2. *Waste Management*: It involves the 3Rs—reduce, reuse, and recycle waste.
3. *Water Management*: It includes harvesting, conservation, treatment of wastewater generated and sufficient delivery of clean water for consumption.
4. *Food Management*: It includes production (local, indigenous, and organic), processing and preservation, and consumption of food.
5. *Biodiversity Management*: It includes care and concern for the plant and animal life through its Governance, Teaching & Learning, Community Partnerships, and Facilities & Operations.

Objectives Of The Study

1. To identify and define the themes and elements of a Green School
2. To identify ways to make schools green
3. To develop a model of a Green School

Research Methodology

1. *Nature of the study*: The study is exploratory in nature as it explores the initiatives or practices that the schools are adopting to make themselves green.
2. *Population for primary data*: Primary data has been collected from schools of Delhi-NCR who have been part of WWF India's Ek Prithvi (One Earth) Conservation Leadership through Education programme for at least one year. "The programme is an action-oriented environment education model where the whole school is motivated to explore, understand and apply the principles of sustainability in their school ecosystem.

It focuses on building conservation leadership among students by enhancing knowledge, skills and action competence to adopt pro-conservation attitudes and sustainable lifestyle choices." (WWF, 2018)

3. *Sample of schools for primary data*: The sample includes those five Jawahar Navodaya Vidyalayas identified by WWF India that are sincerely and effectively implementing the programme in Delhi NCR. The criteria for sample selection include parameters like teacher training, assigning grade-wise responsibility to teachers, time allotted in the time table or academic calendar, documentation work done by the school and the assessment results.
4. *Tools developed*: Table 2 states the tools developed by the researcher for the purpose of research.

Table 2: Tools Developed for the Study

S. No.	Tools	Respondents
1.	Interview schedule for the principals and the teacher coordinator	2*5 = 10
2.	Questionnaire for the teachers	4*5 = 20
3.	Focus group discussion with students	20*5 = 100
4.	Observation schedule	Filled by the researcher

Resources for secondary data

Table 3 shows the resources of the five organisations working on green schools in India that were used for this study.

Table 3: Secondary Resources on Green Schools

S. No.	Resources / Website	Organisation
1.	Paving the Path: A selection of best environmental practices in schools across India	Centre for Science and Environment (CSE)

2.	Paryavaran Mitra Puraskar Exemplar Schools	Centre for Environment Education (CEE)
3.	Wipro's Sustainability Education Program for Schools and Colleges	WIPRO Earthian Program
4.	The Green School Project	The Energy and Resource Institute (TERI)
5.	Towards a Green School: A Manual on ESD for Elementary Schools & A Study of Good Practices on Greening of Schools	National Council of Educational Research and Training (NCERT)

Analysis of the data

Secondary data was analysed first on the principles of framework analysis. Based on the thematic frameworks prepared, the primary data was analysed next.

The qualitative data was analysed based on the principles of framework analysis which involves a five-step process (Ritchie & Spencer, 1994)

1. *Familiarization*: The researcher immersed herself in the qualitative data on green schools by reading various reports, guides, modules and manuals of the five organisations. Through the process, the researcher became aware of the key ideas and recurrent themes, and made a note of them. Due to the sheer volume of data that was available, the researcher studied only five organisations keeping two aspects in consideration—diversity of regions and comprehensiveness of the data.
2. *Identifying a Thematic Framework*: Using the Whole School approach and themes identified earlier, a framework was prepared and tabulated (see Table 4).

Table 4: Thematic Framework of a Green School

GREEN SCHOOL	Governance	Teaching and Learning	Community Partnerships	Facilities and Operations
Energy Management				

Food Management				
Water Management				
Waste Management				
Biodiversity Management				

3. *Indexing*: It involves identifying portions or sections of the data that correspond to a particular set of themes in the framework prepared.
4. *Charting <level 4>*: It implied that the data was then “lifted from its original textual context and placed in charts that consist of headings and subheadings that were drawn during the thematic framework, or from *a priori* research inquiries or in the manner that is perceived to be the best way to report the research” (Ritchie & Spencer, 1994).
5. *Mapping and Interpretation*: Lastly, the data charted was analysed and interpreted based on the objectives laid out for the research, which were to understand the nature of phenomena of green schools and to map the strategies adopted to make the schools green.

Delimitation

The study is delimited to the schools where WWF has been running its ‘Ek Prithvi (One Earth) Conservation Leadership through Education Programme’ in Delhi- NCR.

Green School Model

The model presented below highlights some of the strategies that schools can adopt to make themselves green.

Governance – Vision, Mission, Objectives and Values of a Green School

An example of the vision, mission, objectives and value statement of the Green School is presented in Table 5. However, each of the schools need to develop their own vision and mission statements based on their strengths and constraints.

Table 5: Example of Vision, Mission, Objectives and Values of a Green School

Vision	Mission	Objectives	Values
The students from the school emerge as citizens who use and consume resources responsibly, champion the cause of conservation and become problem solvers in the larger community.	Students of classes 5 th to 9 th participate and immerse in activities based on one of the themes throughout the year.	<ol style="list-style-type: none"> 1. Enable understanding of the environmental issues in the entire school community. 2. Empower teachers with strategies to integrate environmental concerns while teaching any particular subject. 3. Motivate the school community to exhibit environmentally responsible behaviour at all times. 4. Encourage students to raise questions and discuss relevant topics. 	Reinforcing compassion, responsibility, respect for all life forms, and commitment in the school.

Governance – Action Plan and Execution its execution related to the theme of Energy and Waste, are presented in Table 6. Some of the strategies on action plan and

Table 6: Example of Action Plan and Execution in Green School

Green School	Action Plan and its Execution		
Energy	No school vehicle for students and staff residing within 3 kms of the radius of the school. (Source: CSE Paving the Path)	Random checks during recess, free periods using energy monitoring checklist.	Charging monthly parking fee; Waving off parking charges to those car-pooling; giving Green Allowance to those staff members opting for the school bus. (Source: CSE Paving the Path)
Waste	Banning the use of aluminium foil in lunch boxes.	Good on one side paper box can be placed in every classroom.	Collaboration with authorised E-waste dismantler. (Source: CEE Paryavaran Mitra Puraskar Exemplar Schools)

Governance – Team Structure of Classes V–IX, with each class assigned a specific theme, as stated in Table 7. The model recommended in the paper, proposes to engage students and teachers

Table 7: Team Structure of a Green School

Theme	Teacher(s)	Student(s)	Admin/Office/ Caretaker(s)
Biodiversity	One teacher of Class V	Students of Class V	Gardener
Food	One teacher of Class VI	Students of Class VI	Cooks and kitchen helpers
Water	One teacher of Class VII	Students of Class VII	Housekeeping or maintenance staff
Waste	One teacher of Class VIII	Students of Class VIII	Cleaners or maintenance staff
Energy	One teacher of Class IX	Students of Class IX	Office staff and Electrician

Governance – Monitoring and Evaluation

Monitoring and evaluation of the green practices adopted can be effectively done by

setting targets, action to be taken, identifying indicators of progress and documenting the results. Two such examples are presented in Table 8:

Table 8: Monitoring and Evaluation in a Green School

Theme	Target	Action	Indicator of Progress	Result
Water	Maintain per capita water consumption per day (litres) below 25 litres.	Awareness campaign on water conservation.	Reduction in the water bill or units of water consumed.	Reduction in per capita per day water consumption (litres).
Biodiversity	Instil care for the plant life in students.	Engage students in maintaining or creating vegetable garden or fruit saplings.	Students protect and nurture the plants.	Appreciation for plants as well as fruits/vegetables grown.

Community Partnership - Engagement of Parents

Theme Water: Encourage everyone at home to adopt one change to reduce their water use.

Theme Biodiversity: Create a drip irrigation system with plastic bottles for the plants at home, whenever there is no one at home for some days. Alternatively, prepare herbarium during vacations with the help of parents.

Community Partnership – Community Awareness

Theme Waste: Initiate a ‘no plastic zone’ project called ‘Parivartan’ through which the school avoids using poly bags and encourages the use of cloth and jute bags in the school and the local community. In this campaign, cloth bags made by students from waste cloth pieces are distributed free of cost to residents, shopkeepers, and local vendors of the area. Residents are told to get their own cloth bag stitched by the tailors at school free of cost.

Theme Water: ‘Our Gardener, Our Teacher’—an initiative that involves asking the gardener to share less-known ways to save water in the garden.

Community Partnership – Learning from the Community

Theme Waste: Understanding who does what? Contemplate the role and responsibility of local Councils (tax for maintenance of sewerage and waste collection, and organising waste campaigns—Swachh Bharat or Swachh Pakhwada Abhiyaan) and national government and agencies, e.g. Municipal Bodies or land fill site; NGOs voluntary sector/charities (helping others locally/globally like e-waste recycling); and commercial companies. This provides opportunities for inviting speakers and experts from different organisations to elucidate how they are reducing waste, environmental impact, and/or take students to site visits.

Theme Water: Organise a field visit to a wastewater treatment plant, a functioning reedbed or composting toilet, and link it with relevant content areas of the curriculum.

Teaching and Learning - Incorporation in Existing Subjects

Theme Water: How I Get Water: Water Flow-Source to Drain

- (i) *Key Concepts:* The water that flows through the tap comes from a faraway source. The used/dirty water is drained into the water body nearby, or it seeps into the ground and pollutes it.
- (ii) *Before the Activity:* The water cycle is discussed with the students, which they have already learnt in their textbooks. It is highlighted that the water flows and follows a cycle without being polluted. However, once we begin tapping and using this resource, we pollute it. Students are further encouraged to think where all the water goes after its use. Or if they have ever thought of sorting the used water, cleaning and using it again?
- (iii) *During the Activity <level 4>:* Students are asked to draw a flow chart, tracing water from its source in their city to the water point in their home and beyond. For example, rain -> recharges ground water -> pumped and stored in a community tank -> overhead tank at home -> water points at home -> boiled/purified -> stored in container -> wastewater flows down the drain -> drain leads to the river. The source of water can also be from the river or well.
- (iv) *After the Activity:* It is further emphasised that even though water is present in a large quantity on Earth, there are challenges such as scarcity of water, unequal distribution and overconsumption, all of which affects our day-to-day life.

Theme Waste: Biodegradable and Non-biodegradable Waste – What Goes Where?

- (i) *Key Concepts:* Biodegradable and Non-Biodegradable Waste
- (ii) *Before the Activity:* Students are reminded of two scenarios—a natural forest and a human settlement. The reasons for a difference in the waste situation between the two are discussed. It is shared that the waste that degrades or disintegrates naturally is biodegradable waste, while the waste articles that do not degrade or disintegrate naturally are

non-biodegradable. These waste articles continue to accumulate and hence, contaminate the environment.

- (iii) *During the Activity <level 4>:* Students are provided with a list of different kinds of waste found around us, and they are asked to categorise the waste items by putting them into the container to which it belongs: non-biodegradable or biodegradable.

The list includes a banana peel, a leather belt, an empty tetra pack of juice, a styrofoam cup, a toothbrush, a used toothpaste tube, a newspaper, a battery, a glass bangle, dry leaves, an apple, a chips foil packet, a dead insect, a roti, a plastic pen, flowers, green leaves, potato, an old notebook, a soft drink can, a cotton rag, a light bulb, cooked food, a plastic bag and a broken glass bottle.

- (iv) *After the Activity <level 4>:* Students are explained why it is important to know the degradability of different materials (crucial for waste management). It is further shared that even biodegradable waste can cause problems because people generate this at a rate and in quantities that are too huge for the process of degeneration to take place properly. It is like overloading nature's decomposing machinery.

Teaching and Learning - Interdisciplinary Activities and Projects

Theme Food: Facilitate students in creating a mind map of a 'cup of tea' covering various issues related to each of its ingredients: 1. Water (Social: unequal distribution, Environmental: water cycle, Economic: impacts livelihood) 2. Energy (Environmental: sustainable vs unsustainable, Science: efficient vs inefficient) 3. Tea Leaves (Culture & history of cultivation and trade) 4. Sugar (Science: health issues, Social Science: region of production, industry and trade), 5. Milk (Social: vegan vs milk consumers, Science: allergies and intolerances).

Theme Water: 'Knowing Water in my School' is a project to engage students in a water

mapping exercise wherein they understand the source (geography), storage (maths), quality (science), use (social science) and wastage of water in their school.

Teaching and Learning - Co-curricular Activity

Theme Biodiversity: A tree mapping exercise to help students gather information about each of the trees on the school campus and enable them in preparing a plan regarding the maintenance of trees on the campus, naming and tagging them, deciding locations for plantation and species of trees that can be planted. The mapping is done by dividing students in small groups and allocating to each group the different areas of the school campus with trees. Students go to the designated areas in their respective groups and mark every tree with a number using chalk. Care is taken to avoid counting a tree more than once. The trees are then tagged with details about their name, date of plantation (approximate), native/non-native, and its friends (like birds, ants, squirrel, etc).

Theme Energy: Teach designing of a table calendar illustrating simple but highly efficient energy-saving habits to save and conserve energy. For example, use rechargeable batteries instead of disposable ones, turn off lights when not required, etc.

Teaching and Learning - Professional Development Opportunity

Theme Biodiversity: Providing appropriate resources to teachers like *Tending a Schoolyard Garden* by Nyla Coelho.

Theme Waste: Capacity building of teachers on how to help students reuse the wastepaper generated in the school in various ways, like doing craftwork (cutting patterns in different shapes), covering notebooks, cutting shapes for mathematics activity, for spreading on shelves, for decorating display boards, etc.

Facilities and Operations - School Building

Theme Waste: Composting systems, equipment, pits for different types of waste,

like vermicomposting for dry garden waste, can be created by mixing garden waste with cow dung. A channel on the top of the sidewall can be filled with water to keep ants away from the composting pits. Also, put a metal mesh or net above the composting unit to keep insects and flies away. Similarly, biogas plant for wet waste, and microbial culture composting facility for residential waste.

Theme Energy: Install renewable energy generation systems like solar panels for a certain percentage of the total energy requirements.

Facilities and Operations - Surrounding Natural Environment

Theme Biodiversity: Creating theme-based gardens in schools, like colour-based garden (rainbow garden), cactus garden, floriculture plants for smells and textures (sensory garden), specific use like edible garden or kitchen garden or vegetable garden (food garden for growing vegetables like aubergines, lady's finger, cucumbers, green chillies, amaranth, banana, tapioca, etc); a medicinal garden with herbs, flowers and plants used for healing like cardamom, orchid, aloe vera, etc.

Theme Food: A Seed Propagation Challenge is undertaken. In small groups, students collect a range of local indigenous seeds. These could be sourced from a local indigenous nursery, collecting seeds from existing plants at the school or contributions from community members from the fruits and vegetables that they eat.

Facilities and Operations - Resources Flowing through the School

Theme Food: A Healthy Foods Campaign is launched to increase access to healthy foods in school by replacing bottled soft drinks with fresh lemonade or fruit juice, packaged chips with fruit chaat or vegetable salads, etc., thereby increasing fruit and vegetable consumption on campus. Thus, healthy and freshly prepared food items are served like fruit juice, vegetable sandwich,



egg/omelette, rice, roti/poori, pulses/dal, vegetables, porridge, upma, khichdi, curd/buttermilk, lemonade, lassi, etc.

Theme Energy: Switch from LPG to biomass pellets (made of agricultural waste) as cooking fuel. This is done to reduce the carbon footprint as well as the expenses incurred on the cooking fuel.

Conclusion

To make schools green, strong leadership is needed to act purposefully, collaboratively and committedly for the fulfilment of this agenda. Policymakers need to introspect with a new lens to answer questions like what motivates the modern-day student to learn, do contents like waste management, biodiversity conservation, greenhouse gas

emissions, malnutrition and others seem more appealing and relevant today; what are we trying to achieve with education, what should our ultimate learning outcomes be, what competencies or skills are needed by the present learners; and lastly, how to stimulate those capabilities?

The study proposes a 'Green School Model' suggesting strategies that schools can adopt on five themes namely, water, energy, waste, biodiversity and food to make themselves green. Further, to create exemplary models of schools exhibiting environmental responsibility in their day-to-day activities, schools need to adopt the whole-school approach, which means embedding 'green themes' in every aspect of the school culture—governance, teaching and learning, community partnerships and facilities, and operations.

References

- CENTRE FOR ENVIRONMENT EDUCATION. 2017. *Paryavaran Mitra Teacher's Handbook*. Ahmedabad, India.
- CENTRE FOR SCIENCE AND ENVIRONMENT. 2019. *Paving the Path: A Selection of Best Environmental Practices in Schools across India*. Delhi, India.
- GOSWAMI, M. AND K. CHHOKAR. 2014. *Whole School Approach Manual*. WWF India, New Delhi.
- KENSLER, L. AND C. ULINE. 2017. *Leadership for Green Schools: Sustainability for Our Children, Our Communities, and Our Planet*. Routledge, New York.
- SHARMA, K. 2014. *Towards a Green School: A Manual on ESD for Elementary Schools*. National Council of Educational Research and Training, Delhi, India.
- . 2016. *A Study of Good Practices on Greening of the Schools: A Report 2015–16*. National Council of Educational Research and Training, Delhi, India.
- UNITED NATIONS EDUCATIONAL, SCIENTIFIC AND CULTURAL ORGANIZATION. 2006. *Education for Sustainable Development Toolkit*. Education for Sustainable Development in Action: Learning and Training Tools No. 1. UNESCO, Paris.
- . 2006. *United Nations Decade of Education for Sustainable Development (2005– 2014): Education for Sustainable Development Toolkit*. UNESCO, Paris.
- UNITED NATIONS EDUCATIONAL, SCIENTIFIC AND CULTURAL ORGANIZATION AND UNESCO ASSOCIATED SCHOOLS. 2016a. *Schools in Action: Global Citizens for Sustainable Development: A Guide for Students*. UNESCO, Paris. Retrieved on January 2017 from <http://unesdoc.unesco.org/images/0024/002463/246352e.pdf>
- . 2016b. *Getting Climate-Ready: A Guide for Schools on Climate Action*. UNESCO, Paris. Retrieved on January 2017 from <http://unesdoc.unesco.org/images/0024/002467/246740e.pdf>
- WIPRO. 2014. *Sustainability and Water: An Activity-based Learning Program for Schools*. Earthian: Wipro's Sustainability Education Program for Schools and Colleges, Bangalore, India.
- . 2016. *Sustainability and Biodiversity: An Activity-based Learning Program for Schools*. Earthian: Wipro's Sustainability Education Program for Schools and Colleges, Bangalore, India.
- WWF. 2018. *Delhi: Ek Prithvi – Conservation Leadership through Education. Student Workbook for Class 1 to 12*. WWF-India.

Critical Pedagogy and Issue of Social Liberation: A Policy Perspective

Abstract

The need of the hour is to make our children more informed not only in terms of their pedagogical subject knowledge but also to critically engage themselves in their social surroundings. It is the place where they can try to build their future as socially efficient citizens. The critical engagement of school children with their social life demands a new transformative educational structure, different from the present existing educational structure. Here, the role of a teacher with a new curriculum model driven by the critical pedagogy of social liberation would be the only hope of transformation of an undesirable society to a desirable one. In this context, the National Curriculum Framework 2005 and National Education Policy 2020 emphasise the development of a new model of educational curriculum that is, a critical pedagogy. Thus, the onus of responsibilities lies on our teachers to develop critical thinking and problem-solving skills among school children with the help of proper guidance to assist them to 'prepare for life' in dynamic situations.

Keywords: Critical thinking, Problem-solving, Critical Pedagogy, School Children

Introduction

The high literacy rate of a country is one of the strongest indicators of national development. While emphasising multiple definitions of a literate person, the Indian educational discourse in our time has not been able to provide adequate attention to the process of improving quality teaching in the interior and exterior levels of the school education system. We are simply not aware that the literacy figure in India is not a very significant one; a vast majority of parents are still illiterate. The data from empirical studies have indicated that basic education is very positively correlated with the literacy rate in the country. If children do not have access to the basic skills at an elementary stage, then how can we imagine having a remarkable literacy rate in the country? Half of the children passing out from the government schooling system at the primary and upper primary levels have acquired very limited literacy and numeracy skills. As a result, India's school education system

has miserably failed to achieve the primary objective of education that is, helping students to know what to learn, enabling them to relate classroom learning with the cosmology of life reality and also developing critical thinking, which may help them to be good citizens. Nevertheless, the pedagogical practices of our schooling system revolve around the concept of rote learning rather than a pedagogy of critical thinking, a student-centred and democratic discourse, dialogue, empowerment, and liberation, etc., as propounded by the great educationists and theorists such as from Paulo Freire, Ivan Illich, John Dewey, and Mahatma Gandhi. In this conjecture, many questions are raised as to what does education mean for the masses? How does pedagogy work in our school system? How much critical pedagogy is relevant to the concept of the social liberation of the child? Basing on the underlying theoretical premises of "social constructivism" of Vygotsky and "pedagogy of oppressed" as propounded by Paulo Freire, the present paper is an attempt to critically

analyse the concept of engagement of critical literacy to achieve the pedagogy of social liberation in the school contexts through NCF 2005 and NEP 2020 to lay down the foundation in achieving mass literacy in India.

Concept of critical pedagogy in the socio-psychological perspectives

It is a general belief that education brings upliftment of the child in every realm of his/her life. It is also clearly reflected in the tenets of the Hindu belief that education brings someone from darkness to light (*Sa Vidya Ya Bimuktaye*). However, it is still not clear or one can say that what education educating is itself is a perennial question. No doubt, out of many social and philosophical prescriptions, the basic aim of education is to help the child make a sense of life and consequently develop his/her potential which is concretised by the pedagogical practices. Pedagogy has also been defined in a restricted sense as “the art and science of teaching.” It determines how a teacher thinks and acts in a formal set-up that affects students’ lives and expectations. But it is a more inclusive and complex term. In the words of Henry Giroux (1997), who has defined pedagogy from a broader perspective, “pedagogy is not defined as simply something that goes on in schools. On the contrary, it is posited as central to any political practice that takes up questions of how individuals learn, how knowledge is produced, and how subject positions are constructed. In this context, pedagogical practice refers to forms of cultural production that are inextricably historical and political.” Here one can see how the concept of simple pedagogical practices is transformed into critical pedagogical practices. Moreover, the concept of critical pedagogy has been derived and viewed by diversified thinkers and educationists in the domain of education. Many classical thinkers like Paulo Freire, John Dewey, Ivan Illich, John Holt, Henry Giroux, and Ira

Shor have defined critical pedagogy in their major works from different perspectives. For instance, Paulo Freire (1970; 78; 2005) and John Dewey and Lev Semenovich Vygotsky have defined critical pedagogy in socio-psychological perspectives, whereas other thinkers or pedagogues like Ivan Illich, Reimer, and John Holt has analysed the pedagogy of schooling in a very radical way and are known from anti schooling or de-schooling perspectives. Further, theorists like Ira Shor (1992a, 1996b), Patricia Bizzel (1996), Berlin (1996), Butler (1991, 1997), Giroux (1988), Gramsci (1971) have viewed critical pedagogy in postmodern perspectives.

Paulo Freire and Critical Pedagogy

In the academic sphere “critical pedagogy is a teaching approach which attempts to carve a space for students to question and challenge domination, and the beliefs and practices that dominate” (Babu, 2007, p. 6). Critical pedagogy was developed in congruence with the emergence of critical theory at Frankfurt School and the late 19th century’s social and political movements in the Western world. In fact, critical theory highly influenced the commanding works of Paulo Freire who is popularly known as a critical pedagogue. However, the theoretical invention of Brazilian pedagogue, Paulo Freire towards the 20th century pedagogical problems in education has been very substantial and relevant. The innovative and the potential concepts like “Dialectics”, “Empowerment”, and “Praxis”, “Conscientization”, “Dialogue” are the most fundamental to his thesis of social liberation.

According to Freire, the teaching-learning process in the formal setting of the classroom must stimulate the minds of the students critically to see the objects and issues through applying one’s conscientization where the teacher and the taught “both participate in the meaning-making” events.

Criticising the autocratic nature of the teacher’s authority in the class, Freire argues that teaching implies working together, rather than simply talking down to the

students. For Freire, the banking concept “the teacher’s prescription” in the classroom contexts makes the students the passive recipients. Jean-Paul Sartre calls it the “digestive” or “nutritive” concept of education. This concept negates humanisation because it works on the principle of oppression.

There it was said that the problem-solving teaching approach in classroom contexts is directly related to the “*pedagogy of the oppressed*” or “*pedagogy of hope*” (Freire, 1970a; 1978b). It refers to the idea of “conscientization”. To put it another way, “conscientization” can be stated as “developing consciousness, but a consciousness that is understood to have the power to transform reality” (Freire,

1970; 78). Freire’s basic assumption was “that man’s ontological vocation (as he calls it) is to be a subject who acts upon and transform his world, and doing so moves towards ever new possibilities of fuller and richer life individually and collectively” (Shaul 1972;12). Freire’s critical literacy in his pedagogy of the oppressed follows the steps of construction, deconstruction, and reconstruction of the objective world into a subjective world. The details and the systematic steps of Freire’s literacy training are well explained in the model developed by Gerhardt (1997). We can see his model for a better understanding of critical pedagogy (See Box-1).

Freire’s Method of Literary Training

Step 1: *The educators observe the participants in order to ‘line in’ to the universe of their vocabulary.*

Step 2: *An attempt to search for generative words and themes takes place at two levels— syllabic richness and high degree of experimental involvement.*

Step 3: *A first codification of these words into visual images, which stimulated people ‘submerged’ in the culture of silence to ‘emerge’ as conscious markers of their own culture.*

Step 4: *The de-codification of the generative words and themes by a ‘culture circle’ under the self-effacing stimuli of a coordinator who is not a ‘teacher’ in the conventional sense, but who has become an educator-educatee in dialogue with educatees-educators.*

Step 5: *A new codification or re-codification, which is explicitly critical and aimed at action, wherein those who were formally illiterate now began to reject their role as mere ‘objects’ in nature and social history. They undertake to become ‘subjects’ of their own destiny.”*

Source: Gerhardt, 1997, p. 445

Vygotsky and Critical Pedagogy

In spite of that, the execution of critical consciousness depends on the learning and development of the child in the initial years of education which is closely associated with the social background of the child, as argued by psychological theories of learning. In this regard, the social constructivist perspective in the psychological domain of child learning has a root to explain the critical thinking of the child. As Vygotsky argued, “It is through

others that we develop into ourselves.” What is important in his theory is the relationship between learning and the child’s social and cultural worlds.

The theoretical basis of problem posing as a framework for critical pedagogy rests in the Vygotskian notion of *Zone of Proximal Development (ZPD)*. Vygotsky believes that “thought and speech turn out to be the key to the nature of human consciousness.” Further, one can draw the lines that child thinking as a *process of enculturation* is

implicitly emphasised in Vygotsky's theory of learning.

Critical Literacy in National Curriculum Framework, 2005

The *National Curriculum Framework for School Education-2005* implicitly reflects a deep understanding of the traditional values, cultures, and socio-psycho structures of Indian society that constitute India today. Moreover, the document is fixed in such a way to act as an important tool of social change in the Indian society. In this context, a question arises—does the document have the ability for larger social transformation as well as for social liberation? To answer this, it is better to critically see the major principles underlined in *NCF-2005* first and then *NEP 2020*.

Essentially, there are five guiding principles as proposed in the *NCF-2005* document. The first two principles of it have recommended connecting knowledge to life outside the school which means incorporating the experiences of the child into the teaching-learning discourse. Another principle ensures that the learning shifts away from the rote methods which are often practised in the daily classroom discourse. Another quintessential feature of NCF is its constructivist approach to teaching-learning. The basic principle of the constructivist approach is that knowledge over a subject can't grow in isolation. Knowledge relies on the human capacity and "recognising the active capacity of the cognising subject." Thus, it is pertinent to critically examine the concept of critical pedagogy in the recent policies like *NCF-2005* and *NEP 2020* in the light of "Social Constructivist" and Freire's "Pedagogy of Social Liberation" against the vast socio-cultural contexts of the Indian education system.

The national curriculum for schools is essentially a social document, which states not only the directions that the teaching-learning process, syllabus, textbooks,

evaluation and school design will have to take place but also the basic social objectives placed in a given context. that is, *mass literacy*. India is a pluralistic as well as multicultural society with different religious, caste, gender and economic divergences and contradictions.

Taking cognisance of the complex social processes in India will have profound implications for the suggested learning and teaching process of mass literacy. If we accept that the child coming to school is not a "*tabula rasa*" (blank slate), and the teacher is not a behaviourist practitioner, then this means that the complex reality that exists outside the school into which the child is born, and which has shaped the attitudes and dispositions of the parents, neighbours, peer groups, siblings or whatever, will have to be taken into account. Echoing Freire's principles of a dialogical mode of classroom interactions, the NCF emphasises the voices of children. It should be remembered that while children construct knowledge inside the classroom, they are being given values, dispositions, social codes, and even knowledge as finished products outside the classroom—in the world of the adults—which they are simply asked to obey and not ask questions. This supports the "banking concept" given by Paulo Freire. In this context, it is quite observable to see the remarks of the National Focus Group on Aims of Education: "Teaching should be in the conversational mode rather than in the mode of authoritarian monologue. It is in the conversational mode that the child is likely to grow in self-confidence and self-awareness and will and more easily establish connections between the teachings and his own experience." Emphasising education as a lived experience embedded in the *NCF 2005*, Freire points out the classroom teaching in terms of conscientization, which is one of the main tenets of mass literacy in India. In Freireian terminology, the NCF is an action-oriented programme that propels students to become active in the learning process. Furthermore, students and teachers "both

learn, both question, both reflect and both participate in meaning-making.”

The principle of dialogue as defined by Paulo Freire is one of the significant aspects of critical pedagogy that helps in building critical consciousness as discussed in NCF 2005. According to Freire, “dialogue in the academe becomes a civilizing and humanizing agency of beneficial social consciousness, thereby enhancing the idea of community and justice with wider social concerns and effects” (Freire, 1970, p. 65).

Similarly, in regard to construction of knowledge in the teaching learning process, NCF-2005 is based on the theoretical principles of the Social Constructivist approach.

NCF-2005 states that critical pedagogy emphasises the interconnection between classroom knowledge and worldly life. This implies that critical pedagogy accomplishes the social goal of education in the process of knowledge construction in classroom pedagogical practices. This causes one to ponder on some questions: whose knowledge is disseminated by school education? How can culturally defined symbols be transmitted in the same process? Can all these processes of transmission be possible in a classroom? What does NCF-2005 mean to convey in its Social Constructivist pedagogy?

Further, one can draw the lines that child thinking as a process of enculturation is implicitly emphasised in Vygotsky’s theory of learning in NCF-2005.

However, it could be said that the overall underlying principles of Paulo Freire in NCF-2005 are based on progressive education in which “oppression” is a basic variable in the model of human society that education has to deal with. More or less, the major principle of social constructivism in NCF is reflected in *constructing knowledge* from the child’s socio-cultural contexts and experiences. More broadly and explicitly binding all the major perspectives of teaching-learning theories including Paulo Freire’s *Pedagogy of Social Liberation* and Vygotsky’s *Social*

Constructivism, the NCF-2005 defines Critical Pedagogy as follows:

“*Critical pedagogy provides an opportunity to reflect critically on issues in terms of their political, social, economic and moral aspects. It entails the acceptance of multiple views on social issues and a commitment to democratic forms of interaction. This is important in view of the multiple contexts in which our schools function. A critical framework helps children to see social issues are connected to their lives. For instance, understanding of democracy as a way of life can be chartered through a path where children reflect on how they regard others (e.g. friends, neighbours, the opposite sex, elders, etc), how they make choices (e.g. activities, play, friends, career, etc.), and how they cultivate the ability to make decisions. Likewise, issues related to human rights, caste, religion and gender can be critically reflected on by children in order to see how these issues are connected to their everyday experiences, and also how different forms of inequalities become compounded and are perpetuated. Critical pedagogy facilitates collective decision making through open discussion and by encouraging and recognising multiple views.*” (NCF, 2005, p. 23)

An Epilogue

Freire talked about the banking system of education four decades ago, but to date, the Indian educational system practices the same without any inhibition. Our “education system is indeed suffering from narration sickness.” This system takes away all the creativity that would otherwise be the basis for a transformative society.

Achieving mass literacy will not be possible if we won’t restructure the scheme of what is to be taught, what has to learn, what and how has to be evaluated in the classroom. The teaching-learning processes in our educational institutions that begin from pre-primary to higher secondary levels are considerably actionless and unreflective academic drive. A striking feature is that at



the elementary level, our children struggle to memorise the formulae and procedures as instructed by our teachers and elders both inside and outside the schools. Hence, the mammoth task is to facilitate a critical thinking and practical, skill-based pedagogy in academic curriculum and institutions eyeing over a greater social transformation rather than emphasising only over ineffective rote learning system.

In this context, the recent NEP 2020 suggestions are highly appreciable that focus not only on the need for the flexibility to learn but also hopes for critical thinking, rather than rote learning to form the basis for designing the curriculum of social liberation. NEP 2020 promises to integrate critical thinking and problem-solving skills in the curriculum from the foundation level, creating a new generation of creative thinkers and critical writers which will help prepare to tackle the upcoming life reality and will also be useful to conquer the uncertainties of future life. Here, the role of teachers is very imperative as NEP 2020 document implicitly pointed out that the onus of responsibilities will have to lie on our teachers. The teachers will create such an opportunity to the same values of critical perspective and innovative thinking process in their respective classroom teachings. The primary objective of NEP 2020 is to provide quality teaching and also to make teachers the leader of social change and social liberation. Translating this vision of NEP 2020 into reality, the teachers will need to follow the two-step

model in their pedagogical approaches to produce critical thinkers in our classrooms. First, teachers must have to use a 'multi-disciplinary' perspective in the teaching of their pedagogical subjects. By pursuing a multidisciplinary learning method, students will be able to understand and analyse the social problems from various aspects. It would enable them to adopt an integrated approach to the learning method. In the process, teachers can play an important role by making the learning system interactive, promoting students to share knowledge among themselves, and help them develop their thinking ability through classroom debates and dialogues. Second, teachers must have to focus their teaching styles to produce "lifelong learners" rather than producing simple class graduates. For this, teachers will have to constantly engage themselves in the process of adjusting the re-skills and up-skills of their students to prepare themselves for better future roles. In conclusion, it can be said that the hope of having a curriculum of social liberation would be possible only when our teaching will be driven by a critical pedagogical school of thought. To achieve this, teachers can set themselves as a model of social change and leaders for our students.

In such situations, it is important to recall the words of our former president Dr. A.P.J Abdul Kalam, who emphatically said that "learning needs freedom to think and freedom to imagine, and both have to be facilitated by the teacher".

References

- BABU, B. RAMESH. 2007. Schooling for Social Transformation: Need for Critical Pedagogy. *Indian Journal of Education*. Vol. XXXIII, No. 1, May. pp. 5–15.
- BROOKS, J.G. AND MARTIN G. BROOKS. 1999. *In Search of Understanding: The Case for Constructivist Classrooms*. Association for Supervision and Curriculum Development, Alexandria, VA.
- FREIRE, P. 1970. *Pedagogy of the Oppressed*. [trans. M.B. Ramos, 1982]. Seabury Press, New York.
- . 1973. *Education for Critical Consciousness*. Seabury Press, New York.
- . 1994. *Pedagogy of Hope: Reliving Pedagogy of the Oppressed*. [trans. R.R. Barr]. Continuum, New York.

- GERHARDT, HEINZ-PETER. 1997. Paulo Friere. In Zaghoul Morsy (Ed.), *Thinkers on Education*. Vol. 2. UNESCO Publishing / Oxford & IBH Publishing, New Delhi.
- GIROUX, H. 1997b. *Pedagogy and the Politics of Hope: Theory, Culture, and Schooling*. Westview, Boulder, CO.
- ILLICH, I. 1971. *Deschooling Society*. Harper & Row, New York.
- IRA, SHOR. 1992. *Empowering Education: Critical Teaching for Social Change*. Heinemann, Portsmouth, NH.
- National Education Policy, 2020: Ministry of Human Resource Development, Government of India, New Delhi (2020).
- NATIONAL COUNCIL OF EDUCATIONAL RESEARCH AND TRAINING. 2005. *National Curriculum Framework – 2005*. NCERT, New Delhi.
- VYGOTSKY, LEV S. 1978. *Mind in Society: The Development of Higher Psychological Processes*. Harvard University Press, Cambridge, MA.
- . 1986. *Thought and Language*. The MIT Press, Cambridge, MA.
- WERTSCH, JAMES V. 1988. *Vygotsky and the Social Formation of Mind*. Harvard Press, Cambridge, MA.
- WIEDER, ALAN. 2003. Voices from Cape Town Classrooms: Oral Histories of Teachers Who Fought Apartheid. *History of Schools and Schooling Series*. Vol. 39. New York.



Rahul Mukhopadhyay
rahul.mukhopadhyay@apu.edu.in

Archana Mehendale
archana.mehendale@tiss.edu

Policy Shifts in School Education

This study explores the two decades of publication of research articles related to Teacher Education through Open Distance Learning in research journals of distance education and find out the type of delivery modes used, frequency of delivery modes and the communication approaches it follows for the delivery of instructional activities. It further examines the research method, sampling techniques, tools for data collection used in the articles and also the authorship pattern of the articles. The study presented here is a basis towards understanding of the current level of research in the field of Teacher Education through ODL. Keywords: Teacher Education, Open and Distance Learning, Instructional activities, delivery modes, Communication approach, Synchronous learning approach, Asynchronous learning approach, Blended learning approach.

The short version of this paper was presented at national Seminar on conference on Teacher Education through Open and Distance Learning: Challenges and the Road Ahead' at New Delhi from March 27–29 2017 organised by School of Education, IGNOU.

Introduction

The Open and Distance Learning organisations cautiously look for the platforms and appropriate technology-based course delivery modes before launching any new course to cater its learners/users effectively. Heirdsfield, Davis, Lennox, Walker, & Zhang (2007) state that “rapid advances in technology have recently made access to higher education more readily available” (as cited in Amanda R. Hurlbut, 2018, p. 249). The purpose of this review is to put forth the current state and trends of research in the field of Teacher Education through open and distance learning and set future vision in front of the providers of Teacher Education through open and distance learning. To this intention the researcher conducted a review and identified the emerging delivery modes used for instructional activities, communication approaches followed for delivery of instructional activities, research method, sampling techniques and tools for data collection, and the authorship pattern of the articles of Teacher Education through open and distance learning. The comparison

of research articles is carried out to find the trends in Teacher Education through open and distance learning at national and international level.

There are many research topics related with review undertaken in the field of distance education. Mishra (1997) critically analysed the Open Learning, American Journal of Distance Education, Indian Journal of Open Learning, and Distance Education “to reveal the state and status of the subject and research activities on it.” Mishra (1998) reviewed the distance education research literature from the viewpoint of its structure, methodological concerns and priority areas. Mishra (2002) has reviewed the *Indian Journal of Open Learning* from Vol. 1 to Vol.10 (spanning 10 years) and found out the authorship pattern, leading contributors, country-wise and topic-wise distribution of papers, research method, data collection techniques and reference characteristics. Lee, Driscoll and Nelson (2004) have examined research topics, methods, and citation trends using content analysis. Zawacki-Richter, Backer & Vogt (2009) reviewed distance education research from 2000 to 2008 and

analysed the research areas, methods, and authorship patterns. Davies, Howell and Petrie, J. (2010) have explored and summarised trends in research in the topics addressed, research designs utilised, and data collection and analysis methods used in the area of distance education. Ritzhaupt et al. (2010) examined “distance education research by implementing a co-word analysis methodology to identify themes, trends, and structural characteristics in North American distance education literature.” Halverson et al. (2011) analysed the “*American Journal of Distance Education* between the years 2001 and 2010 and found out the trends in topics and categories, methodologies, authors, and word frequency in abstracts and titles.” All the above research reviews/studies have carried out in the area of distance education as a whole. This researcher has not come across the specific review of the articles related with the subject Teacher Education through open and distance learning. This study will put forth the current scenario and trends and set future vision in front of the providers of Teacher Education through open and distance learning.

Methodology

The content analysis technique is used for reviewing the research articles in the area of Teacher Education through Open and Distance Learning. For the purpose, one refereed journal of distance education published in India namely the *Indian Journal of Open Learning* (IJOL) and one refereed journal of distance education published in USA namely the *American Journal of Distance Education* (AJDE) available online in World Wide Web is chosen. All the research articles were studied to collect the required data. In total, 20 volumes of IJOL from 1999 (Vol. 08) to 2018 (Vol. 27) were reviewed and 276 published research articles were analysed. Similarly, 20 volumes of AJDE from 1999 (Vol. 13) to 2018 (Vol. 32) were reviewed and in total, 301 published research articles were analysed. The total number of samples from both the research articles was 577.

Keeping the research objective in mind to investigate the research articles related with Teacher Education (pre-service and in-service) through ODL the units were chosen. The articles which are directly related to Teacher Education or have studied any aspects of Teacher Education through ODL were selected. To minimise the possibility of exclusion of articles related with Teacher Education through distance education, the researcher scanned the title, abstract, participants, data collection and sampling part of the articles and included the article if it relates to the teacher/faculty/academic education. The articles related with other professional training programmes, doctoral programmes or general education courses are not included in this review.

These selected articles were then classified into different categories. They are: the mode of delivery used for instructional activities, communication approaches followed for delivery of instructional activities, research method, sampling techniques and tools for data collection they used and the authorship pattern of the articles. The researcher used the same terminology/expressions of the delivery mode, communication approach, research method, sampling techniques used and tools for data collection as used by the author/authors in the title, abstract and methodology portion of the articles. While reviewing the article, if any of the above elements were specifically not mentioned or visible then it is reported as ‘Not Mentioned’ in the review.

The IJOL had a total of 32 research articles and AJDE had a total of 15 articles which fulfill the inclusion criteria related to Teacher Education through open and distance learning.

Analysis

Publication frequency of Articles

Table 1 shows that out of 577 research articles published from 1999 to 2018 in both the research journals IJOL and AJDE, 47



articles (8.14 per cent) are related to Teacher Education through ODL. Further, it can also be seen that *IJOL* (11.59 per cent) has published more research articles than *AJDE* (4.98 per cent) as far as the publication of research articles related to Teacher Education through ODL is concerned.

Table 1: Classification of Articles of *IJOL* and *AJDE* related to Teacher Education through ODL

Re-search Journal	Total no. of Articles Published	Frequen-cy (Teacher Educa-tion)	Per-centage (approx-imate)
<i>IJOL</i>	276	32	11.59
<i>AJDE</i>	301	15	4.98
Total	577	47	8.14

Delivery modes used

Out of 32 research articles of *IJOL* related to Teacher Education through ODL, only 12 articles (37.5 per cent approximately) have mentioned the delivery mode used in instructional process as per Table 2.

Table 2: Classification of Articles of *IJOL* in Different Delivery Modes Used

S.No.	Delivery Mode	Total article	Percent
1	Computer	1	3.12
2	ICT/education-al/ learning/ teaching technology	1	3.12
3	Multimedia	1	3.12
4	Online/Web/Internet	5	15.62
5	Print	3	9.37
6	Tele-conference	1	3.12
Total		12	37.5

Table 2 shows that the delivery mode 'Online/ Web/Internet' has been used the most (5 articles) for instructional process as far as the articles related to Teacher Education through

ODL is concerned. The delivery mode 'print' is used in three articles for instructional purpose. The delivery modes computer, ICT, multimedia and teleconference also have their presence with 1 article each. From the above observation it can be said that at the national level, the provider of instructional activity for Teacher Education have given the priority to the delivery mode 'online/web/ internet' in comparison to 'print' or other delivery mode.

Table 3 shows that out of 15 research articles of *AJDE* related to Teacher Education through distance education, 14 articles (93.3 per cent) have mentioned the delivery mode used in instructional process.

Table 3: Classification of Articles of *AJDE* in Different Delivery Modes Used

S.No.	Delivery Mode	Total article	Percent
1	Online/Web/Internet	13	86.66
2	Virtual world/ LMS	01	6.66
Total		14	93.3

Table 3 shows that 13 articles have used 'online/web/internet' for instructional process and only one article has used the 'virtual world/LMS' mode for delivery of instructional process.

Communication approach

Table 4 shows that out of 12 articles (37.5 per cent approximately, N=32) of *IJOL* only 11 articles (91.66 per cent approximately, N=12) were found establishing communication approach.

Table 4: Articles of *IJOL* with Regard to Communication Approach

S. no	Delivery Mode	Synchro-nous	Asynchro-nous	Blended/ Mixed	Not men-tioned	Total ar-ticle
1	Com-puter	-	1	-	-	1

2	ICT/IT	-	-	-	1	1
3	Multi-media	-	1	-	-	1
4	On-line/ Web/ Inter- net	-	4	1	-	5
5	Print	-	3	-	-	3
6	Tele-conference	1	-	-	-	1
Total		1	9	1	1	12

Table 4 shows that out of 11 articles, the communication approach of delivery modes of 1 article (9.09 per cent) were synchronous, whereas the approach of the delivery mode of 9 articles (81.81 per cent) were asynchronous. Further delivery mode of 1 article (9.09 per cent) has the mixed or blended communication approach.

Table 5 shows that out of 14 articles (93.33 per cent approximately, N=15) of *AJDE* related with Teacher Education through distance education which mentioned the delivery mode used for instructional process, the communication approach is mentioned in 13 articles (92.85 per cent, N=14).

Table 5: Articles of *AJDE* with Regard to Communication Approach

S. No	Delivery Mode	Synchronous	Asynchronous	Blended/Mixed/	Not mentioned	Total article
1	Online/ Web/ Internet		6	6	1	13
2	Virtual world/ LMS			1		1
Total			6	7	1	14

Table 5 shows that out of 13 articles which mentioned the communication approach of delivery modes, 6 articles (46.15 per cent) were asynchronous and the communication approach of 7 articles (53.84 per cent) were blended/mixed.

Research Method

Out of 32 research articles of *IJOL* related to Teacher Education through distance education, only 25 articles (78.12 per cent approximately) have mentioned the research method used as per Table 6.

Table 6: Articles of *IJOL* with Regard to Research Method

Research Method	Frequency	Percentage (approximately) N=32
Descriptive	12	37.5
Survey	6	18.75
Experimental	3	9.37
Qualitative	2	6.25
Evaluative	1	3.12
Developmental-cum-experimental	1	3.12
Total	25	78.12

It can be observed from Table 6 that out of 25 articles which have mentioned the research method, a majority of the research articles, that is 12 (48 per cent) have used the descriptive research method in the articles of *IJOL* related to Teacher Education through ODL. The survey research method has its presence in 6 articles (24 per cent) followed by the experimental design with 3 articles (12 per cent) and qualitative research method with 2 articles (8 per cent). The evaluative and developmental-cum-experimental research method is used in 1 article (4 per cent) each.

Table 7 shows that out of 15 research articles of *AJDE* related to Teacher Education through distance education, only 11 articles (73.33 per cent) have mentioned the research method.

Table 7: Articles of AJDE with Regard to Research Method

Research method	frequency	Percentage (approximately) N=15
Experimental/ quasi experimental	3	20
Qualitative	2	13.33
Quantitative	2	13.33
Descriptive	2	13.33
Evaluative	1	6.66
Developmental	1	6.66
Total	11	73.33

It can also be seen from Table 7 is that in AJDE out of 11 articles which mentioned the research method the experimental/quasi experimental research method is used in three articles (27.27 per cent) followed by qualitative, quantitative and descriptive method with two articles (18.18 per cent) each. The evaluative research and developmental research method has also showed its presence with one article each (9.09 per cent).

Sampling techniques

Out of 32 research articles of *IJOL* related to Teacher Education through distance education, only 15 articles (46.87 per cent approximately) have mentioned the sampling technique used in the research as can be seen in Table 8

Table 8: Articles of *IJOL* with Regard to Sampling Techniques

Sampling Techniques	Frequency	Percentage (approximately) N=32
Random sampling/ simple random sampling	9	28.12
Stratified random sampling	3	9.37

Purposive sampling	2	6.25
Systematic random sample	1	3.12
Total	15	46.87

It is also observed from Table 8 above that out of 15 articles which have mentioned the sampling techniques used in the articles, the researcher used the random sampling/simple random sampling techniques the most, that is 60 per cent (9 articles). Stratified random sampling technique is used in three articles (20 per cent), purposive sampling in two articles (13.33 per cent) and Systematic random sampling in only one article (6.66 per cent).

Table 9 shows that out of 15 research articles of *AJDE* related to Teacher Education through distance education, only 1 article (6.66 per cent) has mentioned the sampling technique used in the research article.

Table 9: Articles of *AJDE* with Regard to Sampling Techniques

Sampling Techniques	Frequency	Percentage (approximately) N=15
Criterion sampling	1	6.66
Total	1	6.66

Tools for data collection

Out of 32 research articles of *IJOL* related to Teacher Education through distance education, only 22 articles (68.75 per cent approximately) have mentioned the tools for data collection used in the research as can be seen in Table 10

Table 10: Articles of *IJOL* with Regard to Tools for Data Collection

Tools for Data Collection	Frequency	Percentage (approximately) N=32
Questionnaire/ structured questionnaire/ opinionnaire	10	31.25

Scale/standardised scale / reaction scale	2	6.25
Multiple-2 tools	3	9.37
Multiple- more than 2 tools	3	9.37
Interview	1	3.12
Test/test Items	3	9.37
Total	22	68.75

It can be seen from Table 10 that out of 22 articles which mentioned the tools for data collection, a major number of articles, that is 10 (45.45 per cent) of *IJOL* have used 'questionnaire' as a tool for data collection. Interestingly 6 articles (27.27 per cent) have made use of multiple tools, that is two or more than two tools for data collection.

Table shows that out of 15 research articles of *AJDE* related to Teacher Education through distance education, 14 articles (93.33 per cent) have mentioned the tools for data collection used in the research article.

Table 11: Articles of *AJDE* with Regard to Tools for Data Collection

Tools for Data Collection	Frequency	Percentage (approximately) N=15
Interview	2	13.33
Questionnaire	3	20
Online questionnaire	2	13.33
Document Analysis	2	13.33
Essays	1	6.66
Pre-test post-test	1	6.66
Multiple tools (Interview and questionnaire)	2	13.33
Social Network Analysis (SNA)	1	6.66
Total	14	93.33

It can be observed from Table 11 that out of 14 articles of *AJDE*, which have mentioned the tools for data collection, five articles

(33.33 per cent) used the 'questionnaire/online questionnaire' tool in the research articles. Further, the researcher used other tools for data collection such as interview, document analysis and multiple (interview and questionnaire) tools in two articles (13.33 per cent) each. Essays, pretest post-test and social network analysis (SNA) tools are also used in 1 article each (6.66 per cent).

Authorship pattern

The authorship pattern of research articles of *IJOL* related to Teacher Education through distance education in Table 12 shows that single authors have contributed the major number of articles, that is 18 (56.25 per cent). There are 13 articles (40.62 per cent) contributed by 2 authors. Interestingly, there is 1 article (3.44 per cent) contributed by 5 authors.

Table 12: Authorship Pattern in *IJOL*

Number of Authors	Frequency	Percentage (approximately)
1	18	56.25
2	13	40.62
5	1	3.44
Total	32	100

The authorship pattern of research articles of *AJDE* related to Teacher Education through distance education in Table 13 shows that the articles contributed by single authors shares the space equally with the articles contributed by 2 authors with 4 articles (26.66 per cent) each. Three authors each have contributed 5 articles (33.33 per cent), whereas 2 articles (13.33 per cent) are authored by 4 authors each.

Table 13: Authorship Pattern in *AJDE*

Number of Authors	Frequency	Percentage (approximately)
1	4	26.66
2	4	26.66
3	5	33.33

4	2	13.33
Total	15	100

Result and Discussion

1. The data related to the publication frequency of research articles related to Teacher Education through ODL published at the national and international levels in distance education revealed that in total, both the research journals are giving adequate space (8.14 per cent) to the research articles related to Teacher Education through distance education. However, the *IJOL* (11.59 per cent) has far ahead from *AJDE* (4.98 per cent) in giving space to the research articles related to Teacher Education through ODL.
2. The data related to finding out the most used delivery modes in published research articles at the national and international levels for Teacher Education through ODL shows that out of 47 articles (32 articles in *IJOL* and 15 articles in *AJDE*), only 26 articles (55.31 per cent) have mentioned the delivery mode. However, research articles of *AJDE* with 14 articles (93.33 per cent) is far ahead from *IJOL* with 12 articles (37.5 per cent) mentioning the name of delivery mode. Almost all the articles of *AJDE* (14 out of 13) have used 'online/web/internet' delivery mode for Teacher Education through ODL. From the above observation, it can be said that at an international level the providers of instructional activities for Teacher Education are mostly using advanced delivery mode (in terms of technology and communication approach) with the help of new media technologies and the use of conventional delivery modes such as 'print', 'audio/video' 'CD/DVD', 'radio', 'television', etc. has declined drastically. However, at the national level, out of 12 articles of *IJOL*, 5 articles have used 'online/web/internet' which is followed by 'print' delivery mode with 3 articles. It can be ascertained from the analysis
3. The data related to communication approach revealed that the providers of the instructional activity in published articles of *IJOL* related to Teacher Education through ODL preferred the asynchronous approach over synchronous or blended/mixed approach. Whereas in *AJDE* published articles related to Teacher Education through ODL used the asynchronous approach (6 articles) and blended/mixed approach (Using both synchronous and asynchronous approach) having 7 articles in it. It is also observed that asynchronous approach is the most used approach (62.5 per cent) at the national and international levels with 15 articles out of 24.
4. The data related to the research methods used revealed that the majority of the research articles, that is 12 in number, (48 per cent) have used the descriptive research method in the articles of *IJOL* related to Teacher Education through ODL. This result is consistent with other results reported. Mishra (2002) reported that descriptive method (34.12 per cent) was the major approach adopted in the papers published in *IJOL*. In his review of articles published between 1991 and 1996 in *AJDE*, *DE*, *JDE*, and the *Indian Journal of Open Learning*, Mishra (1997) reported a percentage of 47.6 per cent of descriptive papers. However, in the articles of *AJDE* the experimental/quasi experimental research method is used the most in 3 articles (27.27 per cent). This result is not similar to the result of Halverson et al. (2011) who have found the most frequently used methodology to be survey-based research, the method used in more than one-quarter (26.2 per cent) of the studies published by *AJDE*.
5. The data related to the sampling techniques used reveals that in the articles published in *IJOL* related to

that 'online/web/internet' is the most used (69.23 per cent) delivery mode for Teacher Education through ODL at the national and international level.

Teacher Education through ODL, the researcher used the random sampling/ simple random sampling techniques the most, that is 60 per cent (9 articles, N=15) whereas in *AJDE*, only 1 article (7.69 per cent) has mentioned the sampling technique used in the research article.

6. The data related with tools for data collection reveals that a majority of articles of *IJOL*, that is 10 (45.45 per cent) have used the 'questionnaire' as a tool for data collection. When compared, this result shows similarity with Mishra (2002) which reports that the use of questionnaire and scale was in 82.44 per cent cases in the articles of *IJOL*. Similarly, in research articles of *AJDE* researcher have used questionnaire/online questionnaire in 5 articles (33.33 per cent). In both the journals, a total 36 articles have mentioned the tools for data collection and majority of articles (41.66 per cent) have used 'questionnaire/online questionnaire' for data collection.
7. The data related to authorship pattern of research articles of *IJOL* reveals that the single authors have contributed the majority articles, that is 18 (56.25 per cent) whereas 14 articles (43.75 per cent) were contributed by multiple authors. This result demonstrates consistency with the results reported by Mishra (1997) single authors' contributions in Distance Education are more common (61.49 per cent). Mishra (2002) again reported that single authors have contributed 69.45 per cent of papers whereas multiple

authored papers constitute 30.55 per cent. The data related to authorship pattern of research articles of *AJDE* revealed that the majority of research articles, that is 11 in number (73.33 per cent) were contributed by multiple authors. This result is consistent with the result reported by Mishra (1997) that in *AJDE* multiple author papers constitute 53.75 per cent, indicating a trend in collaborative research.

Conclusion

An analysis of 20 years for *AJDE* and *IJOL* shows that both the research journals are giving adequate space to the research articles related to Teacher Education through distance education. 'Online/web/internet' is the most used delivery mode for Teacher Education through ODL at the national and international levels. It is also observed that asynchronous communication approach is the most used approach at the national and international levels for Teacher Education through ODL. At the national level, the trends for research is inclined towards a descriptive research method whereas experimental/quasi-experimental research method is used for Teacher Education at the international level. The random sampling/simple random sampling technique is used the most at the national level. 'Questionnaire/online questionnaire' is the preferred tool for data collection in *IJOL* and *AJDE*. Single authorship pattern is more prevalent in *IJOL* whereas *AJDE* is consistent in showing a trend towards collaborative research.

Reference and Bibliography

- Hurlbut, 2018. Online vs. Traditional Learning in Teacher Education: A Comparison of Student Progress. *American Journal of Distance Education*. Vol. 32, No. 4, pp. 248–266. Retrieved on 10-08-2020 from: <https://doi.org/10.1080/08923647.2018.1509265>
- Davies, R., S. Howell and J. Petrie. 2010. A Review of Trends in Distance Education Scholarship at Research Universities in North America, 1998–2007. *The International Review of Research in Open and Distance Learning*. Vol. 11, No. 3. pp. 42–56. Retrieved in 02-03-2017 from: <http://www.irrodl.org/index.php/irrodl/article/view/876>

- Halverson, Lisa R. Jay A. Bostwick., Shawn R. Cates & Richard E. West (2011). The American Journal of Distance Education, 2001-2010, Educational Technology/july-August 2011 retrieved on 02-03-2017 from: https://www.academia.edu/2538162/The_American_Journal_of_Distance_Education_2001-2010
- Lee, Y., M.P. Driscoll and D.W. Nelson. 2004. The Past, Present, and Future of Research in Distance Education: Results of a Content Analysis. *American Journal of Distance Education*. Vol. 18, No. 4. pp. 225–241. Retrieved on 12-12-14 from: http://dx.doi.org/10.1207/s15389286ajde1804_4
- Mishra. S. 1997. A Critical Analysis of Periodical Literature in Distance Education. *Indian Journal of Open Learning*. Vol. 6, No. 1&2. pp. 39–53. Retrieved on 01-03-2017 From: <http://journal.ignouonline.ac.in/iojp/index.php/IJOL/article/viewFile/235/134>
- Mishra, S. 1998. Distance Education Research: A Review of its Structure. Methodological Issues and Priority Areas. *Indian Journal of Open Learning*. Vol. 7, No. 3. pp. 267–282. Retrieved on 01-03-2017 from <http://journal.ignouonline.ac.in/iojp/index.php/IJOL/article/viewFile/226/125>
- Mishra, S. 2002. Ten Years of Indian Journal of Open Learning. *Indian Journal of Open Learning*. Vol. 11, No. 2. pp. 279–290. Retrieved on 01-03-2017 from: <http://journal.ignouonline.ac.in/iojp/index.php/IJOL/article/viewFile/539/412>
- Ritzhaupt, A.D., M. Stewart, P. Smith and A.E. Barron. 2010. An Investigation of Distance Education in North American Research Literature using Co-word Analysis. *The International Review of Research in Open and Distance Learning*. Vol. 11, No. 1. Retrieved on 17-03-2017 from: <http://www.irrodl.org/index.php/irrodl/article/view/763/1483>
- Zawacki-Richter, O., E.M. Baecker and S. Vogt. 2009. Review of Distance Education Research (2000 to 2008): Analysis of Research Areas, Methods, and Authorship Patterns. *International Review of Research in Open and Distance Learning*. Vol. 10, No. 6. Retrieved on 08-10-2020 from: <http://www.irrodl.org/index.php/irrodl/article/view/741/1461>

Values in Education: An Astounding Wealth of a Nation in the Contemporary World

Abstract

If education is the right of every learner in equipping himself to face challenges in life, then the values are the individual principles or qualities that guide his journey through the rough and tumbles of life. The education in its full essence is the process of transmitting values in the learner and developing human personality in all its dimensions as physical, intellectual, social, ethical and moral development. Good education is inconceivable if it fails to inculcate values essential to social well-being for an honourable life. Values are the great foundations on which our society dwells and an organisational culture is constructed and a social decorum is maintained. They are the invisible wealth of a community and of a nation in determining, guiding and reforming behaviour of the citizens of the country. The history of humanity is to a large extent the history of values and where education defines the methodical unified efforts made towards learning basic facts about humanity. Any educational process devoid of such values will ultimately tarnish the glory of a nation in coming times. Exemplary citizens are made and not born. Education paves the way for captivating values. It would be rather difficult to build a dignified nation without adding values in their resources say human too. True power of value-education lies in ethical principles such as respect, honesty, empathy, equality, solidarity and critical thinking signifying quality tags that should be exemplified and dissipated at every phase during learning cycle of pupils. This research article is focused on the perspectives of value laden quality teaching that manifests intellectual depth, self-reflection, rational thinking that are fundamentals to live in harmony and sustaining overall progress. The article addresses the positive correlational approach among value education, quality education and development of human resources. It advocates to address the loopholes in education system thus, ensuring a schematic framework full of resources for building well-mannered, emotionally-balanced, scholarly-productive, ethically and spiritually value-enriched future society contributing towards morally strong and academically skilled learners beyond the surface factual learning. Hence insights of value education offer newer probes in curriculum and academic agendas of present world. Keywords: Value education, Quality education, Human resources, Organisational culture, Curriculum

Background and Rationale of the Study

Value education can contribute immensely to a culture of peace, cohesion and collaboration in the society. Society inculcates values in individuals through its various tools and institutions at each stage of life. The different aims of education are the organised efforts to transform a learner into a form of life that is

deemed fit to be called wealth in the society and a heritage of a nation to be preserved and promoted for future generation. In 1938, Murray defined values as being the cognitive representation of internal needs mediated by external presses. Kluckhohn (1951) defined values as “a concept of desirability.” “A value is a concept, explicit or implicit of the desirable which influences the selection from available modes, means, and ends of action.”

Levy in 1993 defined values as “preference for a certain form of conduct”. In general, we can say that values are principles or rules to lead a responsible and civilised life. Value education is an interchangeable word with Moral education, Ethics Education, Character education and Life skills. Though each variant bears a specific meaning, yet they share the commonalities in a wider context. Earlier beliefs connote that the values being instilled in a child are due to the family rearing practices, the beliefs and religious deeds followed in their culture, and school functioned in value-neutral mode. But it overlooked the fact that the school is a miniature of society and it plays a major role in inculcating values in all realms of the learners, including academic achievement and advancement (Zajda, 2014 ; Mondal, 2017). Such insights promote educational system as well as teachers to disseminate the essential values as an integral part of curriculum (Yazdani et al., 2015). It is an essential component with the greatest responsibility of the education system to inculcate values in students and explore the gradual depleting values in all realms, emphasising the holistic personality development of pupil.

Recent research has unveiled the efficacy of teaching practices at different levels to provide values that enrich learning. Various studies explored what actually works in value education and highlighted that interactional-practices, professional-development, parental-involvement, role-modeling, and community service-opportunities has major importance in inculcating values among young growing lads. Effective pedagogies, and democratic classroom environment accentuate values within learners in the schools. It fosters positive, ethical, social inclinations and competencies in youth, along with academic-achievement and advancement (Berkowitz, 2011). Education is not mere a cognitive and practical skills enhancement but it is an amalgamation of the personal morality and cohesive citizenry. Essential edge in educational global

scenario is now focused on value based holistic development of children along with an academic structure. This underscores a present need to integrate ethics, civics, citizenship and value education trailed in diverse forms into mainstream curricula or can be imbibed as free standing pillar (Ledden et al., 2007; Lovat, 2005; McLean, 2012)the closest possible links need to be found between it and the world of teachers and schools. Teaching has undergone a revolution over the past decade or so. Updated research into the role of the teacher has uncovered the true potential of the teacher (and, through the teachers, the school. Transmitting value education sensitizes human wisdom to understand the different perspectives of life and to move ahead in a life with successful vision (Vijaya & Paul, 2018). It strengthens relationships and bonding in a society and makes a person a responsible citizen of nation. Education revolutionizes the way of thinking, transforms the young minds and make them to think out of the box and liberate them from mental slavery to develop a rational behaviour and all-round development (Terry Lovat & Toomey, 2009). Values in education is analogy of a gem in ornament which adorns brightly the essence of its existence.

Highlights of Value Education in the Global Context

Pursuing a modest agenda, educationists argued for which factors constitutes the values and which values should be given priority to be emphasised during schooling (Yazdani et al., 2015). Major views hold a strength in following a coherent approach to value education for efficient and operative transmission and take up of values among learners (Hofer et al., 2007)students (N = 704, mean age: 13.5 years. A severe decline in ethical and moral values in many societies worldwide especially youngsters who in fancies of materialistic world has contributed towards deformities of the democratic competence and value conformity

(Stephenson & Killeavy, 1998). Throwing light over socio-global perspectives indicates values distortion and moralistic issues universally. Due to value crisis (Halstead & Taylor, 1996) education has repercussions for a civilised society in the long run. In lust of wealth for speedy monetary gain by fair-foul means, values are distorted by being driven by a self-centered attitude. Values are destroyed and deformed fully by educated technically smart minds who execute cyber-crime, financial-frauds etc. using their knowledge for wrong means in wrong way, similarly in medical field where doctors while keeping humanity aside do the black marketing of organs for transplantation. Keeping above views, here is an urgent necessity to glorify the education scenario with bright-light values (Hyttten, 2015). In this pursuit, World Education Forum in collaboration with UNESCO, UNICEF, UNDP, UN, UNHCR, World Bank and UNFPA in 2015 set a new vision for education in the next 15 years till 2030 with a promising note of quality education with improved learning outcomes (UNESCO). The mandate includes empowered teachers and Teacher Educators, who must be professionally qualified, well-trained, enthusiastic, supplied with sufficient resources, adequately recruited in a well-organised and governed education system. Forum ensured an education with quality fostering creativity, augmented knowledge and assure foundational literacy and numeric skills along with meta cognitive, interpersonal and social skills. Values based education were prioritised to enable learner's transformation into a responsible citizen to live and sustain in a cultured civilised life, and to take up the challenges through education for sustainable development (ESD) and global citizenship education (GCED). UNESCO report focuses largely upon "Learning: The treasure within" to explore how an education in 21st century shape the future of humanity and the planet. South east Asian countries like Malaysia, Indonesia, Philippines, Singapore, Japan increased their attention towards

moral based education in schools (Thomas, 1991). Each nation's motive is to improve value education through development of spiritual, social, character, cognitive and moral dimensions. An education which develops concerns and sensitivity towards environment, society and global community, and an education which promotes cultural as well as democratic values among citizens of the nation is targeted as an ultimate agenda to strive for (Thomas, 1991). These nations share common targets and are in continuing process to implement value-instructions in the schools to tackle the tremendous challenges and opportunities to bring desired changes in thought patterns and behaviour of learners, thus moving towards achievement of the predicted, possible and preferred brighter times.

A continent like Australia (Lovat, 2007; Lovat, 2005) the closest possible links need to be found between it and the world of teachers and schools. Teaching has undergone a revolution over the past decade or so. Updated research into the role of the teacher has uncovered the true potential of the teacher (and, through the teachers, the school also realised the importance of value-based education and constituted framework for a value-laden curriculum. A national value-education policy was launched by the Australian government in 2005 called the National Framework for Values Education in Australian Schools (NFVEAS) that highlights the student's centric international education movements and focused on particularly civics-citizenship education, values inculcation and character education in their national curriculum (Jones, 2009). In American public schools, significant emphasis is given to the transmission of values with upheaval in academic excellence amid some existing inner conflicts in the arena of values education. The confusing point is that which values need to be taught, focused, and prioritized more. Civic education deals with training in citizenship for responsible civilised nationals (Eskew, 2004). Education in America focuses for



moral behaviour and ethical responsibility with civic values (Bower, 1952). Teacher education development in Ireland and United Kingdom explores the attitudinal dispositions to the values dimensions of teaching and their real practice in schools and classrooms with regard to values education. The study concluded that values are remote-control, checks the evils and vices and unacceptable behaviour through the counter-productive teaching styles (Stephenson & Killeavy, 1998). A study of Sweden wherein Robert Thornberg investigated teacher's perception towards value education and highlighted their considerations that values are unplanned, integral part of habits, reflecting the pupils' behaviour and are unconsciously performed. Further professional knowledge among these teachers in the domain of values education was found missing (Thornberg, 2008).

Further in Islamic countries spiritual, moral, character and religious education is transmitted for developing quality features in personality as a whole (Nuriman & Fauzan, 2017). As a matter of fact, these countries hold a base that religious and civic education has an integral linkage of spiritual and moral development. It opens up the mind to set target over being responsible citizenship, and focus on human rights, respect and duties towards each other (Farooq et al., 2015). Islamic nations seek a wider acceptability for inclusion of religious and ethics-based education in school curriculum to build socially responsible, sound and morally boosted-up behaviour to lead peace in nations and entire world (Nuriman & Fauzan, 2017). It was noted that moral values-based education has brighter implications for human existence and survival (Hyttén, 2015). It gives a glimpse of hope for positive change in society where people can live together with peace and harmony (Syarif, 2020). Considering the fact, it is of utmost importance to conjunct polar dimensions of knowledge i.e. Conceptual-framework, Techniques/Procedure, and lastly a moral insight, all three reflecting "know that, know how to, and know why". Union of these three

will give better clarification and indication of type of education to be transmitted within a society for living with harmony and peace in a state.

A Nation's Commitment Towards Values in Education

National framework enshrines a vision for value education in Indian schools and pointed out few core values that should be articulated in the curriculum framework viz. pursue excellence, care and compassionate nature, fair deal, freedom, honesty, trustworthiness, forgiveness, integrity, respect, responsibility, understanding, religious-tolerance and inclusion (NCERT, NCF 2005). Government envisages the inculcation of these values in curriculum, plans and policies to attain an explicit goal of education (Ministry of Human Resource Development, Govt. of India, 2016). Government initiatives for assimilating values in education to make human resources as potential worth will reckon on through a provision of providing a safe and optimal learning environment with positivity within and beyond the classrooms which assists in developing social, moral and civic ethical values among learners. Values instilled in learners reflects an effective pedagogy introduced within curriculum and is a mirror image of the appropriately implied quality teaching procedures by the teachers with appropriate resources during teaching learning process to monitor the values endurance (CBSE, 2012). National Policy of Education (NPE) has formulated many programmes, plans and strategies with time to empower the active participation of students to foster their local, national and global responsibilities to build resilience and civic values in them (Ministry of Human Resource Development, Govt. of India, 2020). It also addresses towards behavioural management, discipline, violence, bullying, tolerance to other religious values, humility, loyalty, justice, adjustment and compromise, health and well-being, intra and inter-personal communications and relations

and student’s personal achievement. NPE in chapter VIII, encrypted about the re-orientation of educational content and processes. NPE drew attention towards the gradual depletion of essential values from man-kind and upraising cynicism in society (MHRD, Govt. of India, 1998; 2016). It accentuates education as a powerful tool for readjustments within curriculum to cultivate ethical, social and moral values. Further NPE grows concern towards value enriched education in culturally rich Indian society which could better develop universal and eternal values orienting towards the union and national integration in citizens. Such value education eradicates obscurantism, religious fanaticism, violence, superstitions and fatalism prevailing in society. Apart from this, it prioritises the heritage, national and universal goals and perceptions (Government of India, NPE 2020).

Table 1: Value Education: The Scenario in 20th Century

Commissions / Policies / Committees	Salient Features Addressed
MUDALIAR COMMISSION (1952–1953)	<p>Figured out the defects in education system and reoriented the aims and educational objectives to develop qualities of discipline, cooperation and leadership to transform learners to useful productive citizens.</p> <p>Democratic, intellectual and aesthetic values were emphasised along with social sensitivity, and sense of global-citizenship rather than national citizenship to discharge duties of humanity.</p> <p>Emphasis laid on religious-moral instructions on a voluntary basis with parent and management consent after school hours. Character making education was targeted.</p>

SRI PRAKASA COMMITTEE (1959)	Central Advisory Board of Education organised a special committee on religious and moral instruction and focused on adoption of active measures to redirect value-orientation to education without which holistic development is not possible.
KOTHARI COMMISSION (1964–1966)	Work experience and national service programmes as an integral part of education to serve community and reconstruct nation through a sense of social commitment, self -help, and character-formation. Commission pointed towards inculcation of right values among learners for cultivating moral and spiritual values and strengthening and deepening of social concerns and responsibility.
NATIONAL POLICY ON EDUCATION (1986)	Reconstruction of national core curriculum and focus towards eroded essential values and refurbishing learning with secular, scientific, spiritual and moral values.
PROGRAMME OF ACTION (POA-NPE) (1992)	Recommended value education as a core discipline of course-curriculum with focus on values enriched learning towards observance of national goals, universal perception, ethical considerations and character building and simultaneously curbing obscurantism, religious fanaticism, exploitation and injustice. Main emphasis on education developing citizens with sound character and a healthy personality who can explore essence of dignified life with virtues, goodness, moral conduct, humanity for living in peace and harmony.



S.B. CHAVAN COMMITTEE (1999)	In-depth analysis of value-based-education highlighted on molding of national character and multifaceted spiritual, intellectual, physical and ethical development of learners.
------------------------------	---

Source: Compiled from existing reports of MHRD (now Ministry of Education), Govt. of India.

Heralding Value Education in the 21st Century

Education is deeply rooted within the physical, cultural and moral fabric of a society since infancy stage of the upbringing of an individual. It is not just lesson delivery but long-lasting lessons for life to lead the world for good. Post-2020, several plans and policy initiatives of government of India enunciated upon an education for real learning and a better livelihood for one rather than idealizing oneself of being educated superficially. Some of the important key policies and government led schemes of 21st century are discussed below.

National Curriculum Framework (NCF)-2005

The National Council of Educational Research and Training (NCERT) developed the National Curriculum Framework (NCF) in 2005 and sets guidelines to develop syllabus and textbooks for all grades and focus on fostering ethical values. The framework highlights the education for peace, development of life skills and ethics, inculcating values, attitudes, skills for character building, peace and harmony with the self and others. NCERT developed Value-Education-Framework called “Education for Values in Schools” which enlists the guidelines to identify the priorities of appropriate values to disseminate at different grades in schools through distinct approaches and effective pedagogy. It highlights the interplay of varied cultural environment in which the learner

is reared. It intends to prepare learners to appreciate the beauty of diversity and to live in a multi-lingual, multi-cultural and multi-religious nation with harmony and peace. This framework also designed a “Resource Book for Teachers” titled *Ways to Peace*. It opens avenues for professional development of in-service teachers through various online courses, training packages, capacity building programmes, e-content development, seminars, etc., to augment the potential of teachers as they shape the future of a young growing generation (NCERT, 2005).

National Curriculum Framework for Teacher Education (NCFTE)-2009

It proposed a process-based Teacher Education programme with emphasis on equipping individuals with content-enriched, value-oriented education. It re-organised Teacher Education curriculum highlighting the vision of education in India: its issues and concerns. It also proposed to organise workshop on issues of gender, identity, social and personal conflicts and recommended intensive internships with schools to integrate general education with professional development of teacher (NCFTE, 2009). The framework identifies the symbiotic relationship existing between the two departments of Teachers Education and School Education, as both these mutually deal with the entire spectrum of education. It was realized that success lies in strengthening these two systemic pillars, and ignoring anyone will not entail the quality product in education sector. Moreover, ICT and e-learning is a cardinal point in this framework in addition to the inclusive education, equitable and sustainable development and role of community in education (NCFTE, 2009).

Central Board of Secondary Education (CBSE)-2012

The Value Education Manual and Values Education Kits framed by CBSE contain Value Cards and a CD of songs symbolising peace, value, solidarity and respect for nature. This

is for Classes I–VIII and a Teacher’s Manual on Environmental Education and Adolescent Education has also been framed to accentuate values among learners and organise capacity building programmes in value education for teachers at frequent intervals in a year (CBSE, 2012). Considering value education as a core component of quality education, the Board issued guidelines to assess students at the summative assessment level for 5 marks in every subject through questions integrated with content and the value it shall reflect to provide a holistic education.

National Policy on Education (NPE)-2016

It recommended mandatory value education to promote equity, social justice, tolerance, social cohesion, national integration and to disseminate information, knowledge, skills and values in a way to instill social attitude for developing a good proud citizen. It further emphasised on inculcating core universal values of satya (truth), dharma (righteous-conduct), shanti (peace), prem (love) and ahimsa (non-violence). Teachers, parents and community leaders must join hands together in instilling ideal values among pupils. Owing to the demand and necessity of the present social milieu, it is an indispensable requisite for schools to inculcate not only skills but values and attitudes to live an honourable and civilised life. Schools are directed to take up the responsibility of instilling values like regularity, punctuality, cleanliness, good conduct, humility, respect for women, compassion and care for disadvantaged sections of society (Ministry of Human Resource Development, Govt. of India, NPE 2016).

5. National Policy on Education (NPE)-2020

This policy proposes holistic and multidisciplinary education with innovative and flexible value-laden curricula by recommending project work in the field

of community services, environmental education and value-based education so as to imbibe the values of humanity, ethics, Indian constitutionalism and universal human values, scientific temperament, life skills, moral, spiritual and citizenship values. It raises several concerns towards Global Citizenship Education (GCED) to get insights of global challenges and to promote peaceful, tolerant, inclusive, secure and sustainable societies. Teacher Education programmes with multidisciplinary perspectives, focusing on formation of dispositions and values are imperative in strengthening educational functionality. Teachers must be grounded in Indian values, ethos, traditions and cultural values, and must be well versed with latest advancement in education and pedagogy. The policy undertakes to set an agenda for sustainable development to ensure equitable quality education by 2030. It reconfigures the education system as a whole to develop and foster character, ethical, rational, compassionate and caring values among learners. It embodies a vision of India for 2040 to “Transform India into an equitable and vibrant knowledge society as a global knowledge superpower” (MHRD, Govt. of India, NPE-2020).

Societal Transformation Enunciated by Value-based Education

Education is not a destination but a lifelong journey of learning where the highway is transacted with several learning notes engraved on every milestone passed by. The quality of education that one receives is a marker of the future it can lead (Farooq Shah et al., 2015; Halstead & Taylor, 1996; Holdsworth, 2009). As Nelson Mandela put it, “Education is the most powerful weapon through which you can change the world”. He proclaimed that education can be the greatest tool to shape our thoughts. But such education should holistically be filled with an ethical education to support one in all phases of one’s later life. If a



national curriculum embodies the quality of knowledge dissipated then the values are the precious jewels that decks the education of a prosperous nation. Value-based education is a potent panacea to curb anti-social threats and evils prevalent in Indian society. Transfusing character values in learners paves the way of utilizing the knowledge for benefits to whole mankind (Adams, 2011). It provides a skeletal framework for holistic development towards moulding a child into a winning personality and cherishing everlasting attitude of victory leading the way of all human endeavours. Values entails a radical change in perception and behaviour of a child. Values in education makes the students responsible and sensible towards society and nurtures every individual as a well-balanced personality with strong values inherent in their habits and praxis (Hofer et al., 2007) students (N = 704, mean age: 13.5 years. An educated society is like a silver line in the black clouds where a socially acceptable individual immersed with moral and ethical values shall cherish and uphold the duties as a responsible citizen of a progressive country. Nothing can beat a nation and deter its essence if the education finds its roots soaked in values which enable an individual to counter forces of the outer world with an optimistic frame of mind (Terry Lovat & Toomey, 2009).

Values Education as a Hallmark of Quality Education

Scientific and technological advancement has made this world a materialistic society which is simultaneous recreation at one end while loss of immense values at the other end. A change in life style from joint to nuclear family pattern has led a drastic change in behavioural pattern of the growing chaps. Working culture of both parents in present times has brought up varying differences in inculcating values among their children as they are unable to spend a desirable optimal time with their wards. At the other

side, schools are also withering away from their missions and mottos with fragmented transactions of values among the learners. Value-crisis is now a global episode because of improper dissemination and avoidance of value-based education. Though government plans and policies has articulated many initiatives and developed mechanisms in protection to it but are been overlooked by schools competing to earn the money under business ideology and inclination for market gains. Indeed, there is an imperative need for values-based education that connotes an insignia of quality education integrated with core and peripheral values of human integrity.

Values-based education in different dimensions viz. character, ethical, moral, spiritual, aesthetic, environmental, democratic, cultural, emotional and personal values for holistic development of pupils should be focused for all round development. But the fact lies within this treasure that values are not just a content of mere delivery, taught, lectured about or professed, they are to be exemplified and demonstrated for yielding quality product. Therefore, value-oriented teacher education is the urgent necessity of the global education scenario (Ministry of Human Resource Development, Govt. of India, 2016; 2020; Mondal, 2017; NCERT, 2005). Here comes a challenge to prepare efficient teachers who can act as a role model for growing minds. The two challenges of stability and change must be concentrated upon, stability towards the preserving of cultural and ethical values and change deals with the technological advancement. To knock-off these challenges, National Council for Teacher Education (NCTE), promotes the use of ICT as a change agent in schools towards revamping the teaching learning processes alongside persistence of human values befitting to a democratic society like India.

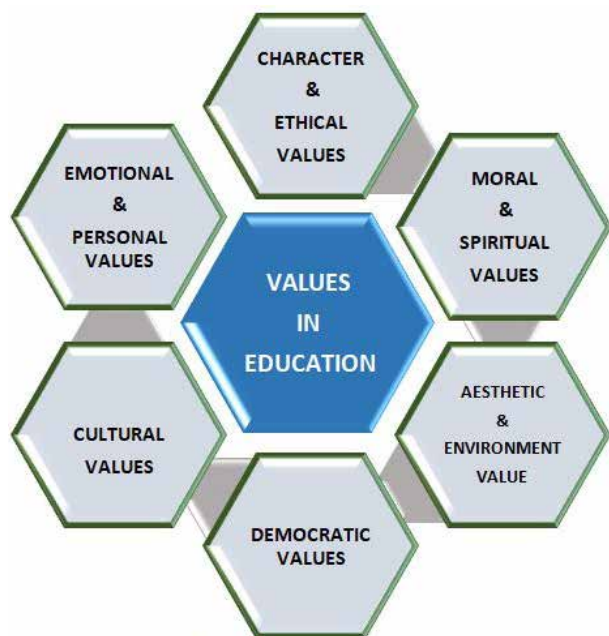

Figure 1: Dimensionality of value education

Pursuit of material wealth, self-centeredness, westernisation, lack of social concerns, moral vacuum and communalistic sensitivities all have eroded the value-enriched Indian culture. A reformation in education can pave the way for quality education. Value education and quality teachings are interwoven just like a double helix of DNA, with both strands being counterpart of each other loses their cardinal virtues if separated out—the half Helical part symbolising value education and other half the quality education (Lovat & Toomey, 2009). Technical, managerial and effective teaching strategies assist in bountiful consequences in terms of academic and personal development. Teaching with suitable pedagogies will help more. Values are laden in pupils when a quality teaching aimed for excellence in targets towards achievements are explicitly outlined. Teaching in a small heterogenous group when engaged under an energetic and inter-personal learning task with application of various skills like cooperation, discussions, discipline within classroom structure, will make learning meaningful and novel with quality adjustments and enhancements

among learners (Lovat & Schofield, 2004). Cooperative learning-based modern practices in classrooms teach students to work and learn together with inclusive and cohesive learning. Effective pedagogy escalates thoughtful knowledge, metacognition and self-discourse among learners, providing for many opportunities in value-and-goal oriented learning. Quality teaching is value-laden where dynamic interactions among contents, teacher-students and optimal learning environment stimulate affirmative learning outcomes. This transforms a man into a human entailing nobilities and gentleness with superior benchmark values (Sahin, 2019). Missing links between value education and quality education are targeted now to bridge the gap by implementing diverse teaching technologies. The idea behind this strategy is not to lose focus of peer support through which values can be better inculcated within their characters and dispositions. A positive relationship with peers, a calm and contemplative learning environment, emotional and spiritual spaces, and ethics in learning habits will significantly bestow values on them (Berkowitz, 2011; Bilgiler & Araştırmaları, 2013; Kay, 2006; Lovat & Schofield, 2004). Directive planning towards value-oriented education explores the ways for a groomed citizen in a developed society wherein values are looked upon as the gems embedded in human character and its perfection.

Bridging Gaps in Value-Oriented Education in the Indian Context

Due to globalisation of education, the world has now turned into a village where it has become very easy to gather information at the click of a mouse. Due to rapid advancement, an education system has traversed through its original approach under a business orientation. India is a land of diversity with variations in caste, creed, religious faith, traditions, rituals, festivals, languages, cultural practices etc. Because of extreme diversity the value bears many inner

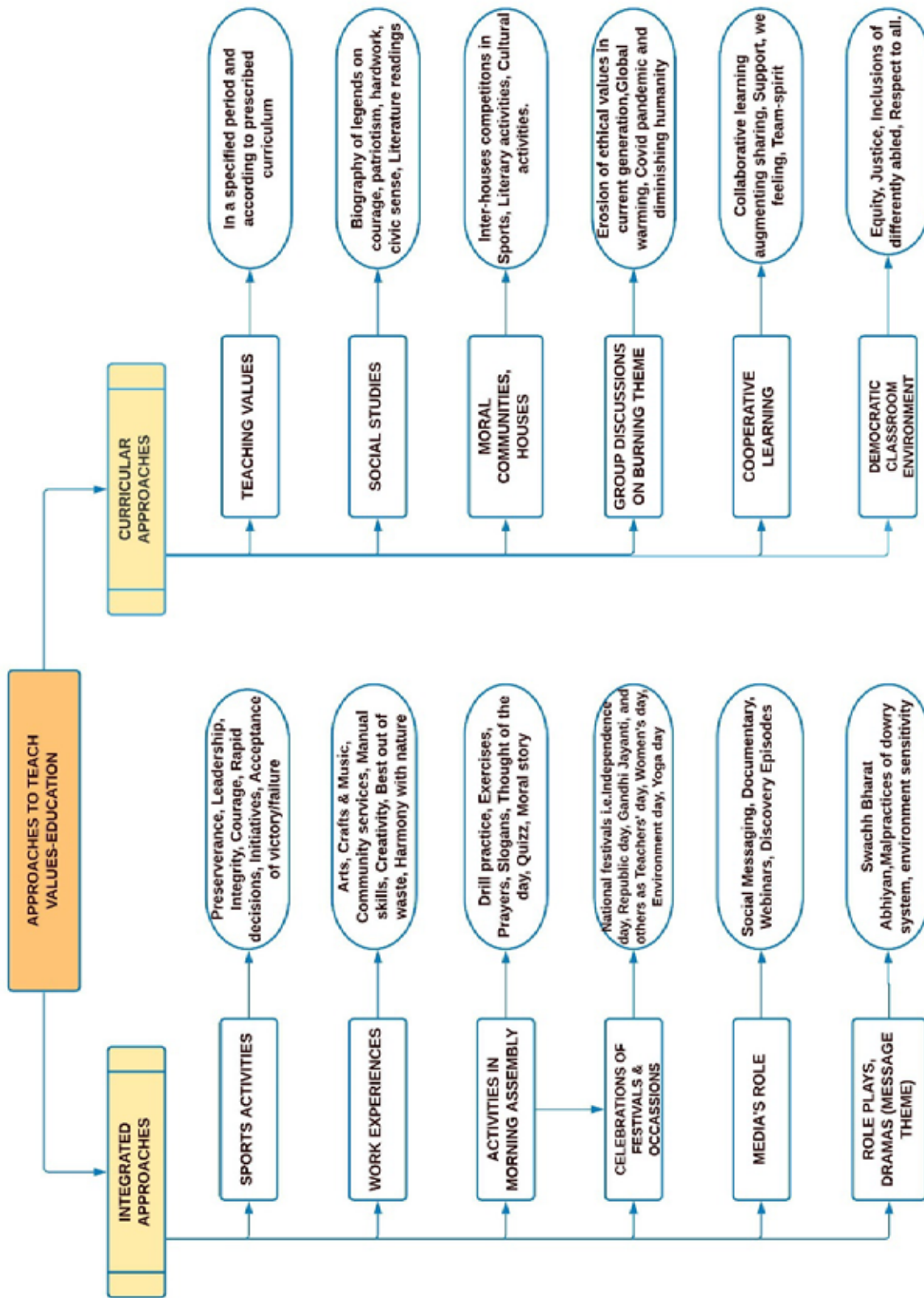

Figure 2: Distinctive approaches to foster values among learners

conflicts within society, and so our country is struggling hard to get control of fractured moral landscape. Here lies an urgent need to nurture a mindset which is self-introspective, self-critical, self-decisive for right or wrong, one with zeal, a strong craving for knowing the truth, one with respect for diversity of societies and the ability to accept unity in diversity.

Values are the determinants of educational objectives where Bloom's taxonomy involving cognitive, psychomotor and affective domains are the targets to achieve. An effective pedagogical approach has to acquire through which values can be inherent to the students. Foremost thing is to give due weightage for opening up new ways to make teachers resourceful so that they can critically reflect their roles as a value educator (NCERT, 2005). For this, Teacher Educators, in-service teachers should be provided structured and reflective curriculum having incorporation of subject matter with varied dimensions for teaching values. Strategies which are found more suitable and appropriate should be involved in renewal of pedagogical processes in schools (NCTE, 2009). It calls upon an emergent need to train teachers by equipping them with skills needful for value-based teachings. Teacher Educators are ensured towards a binding commitment that they pass these values in the generations ahead during their professionalism.

Further, pre-service teachers shall be put under an obligation that they could identify the diversity among learners, pinpoint values to be instilled and focused more while they shall teach in the classroom throughout their career. Equipping pre-service teachers with quality teaching through some specified programmes shall upgrade their proficiency and competencies in an enriched and skillful teaching profession. Internship programmes during practice teaching period should be given ample timespan to firmly imbibe the values that augment intellectual thinking in trainees (Kay, 2006; NCTE, 2009; Zajda, 2014). Since last few decades,

quality teaching is given prime attention to improve students' academic as well as holistic development. Varied approaches to foster values can be represented through a flowchart (Figure 2). Value-based pedagogy creates affirmative impressions with wide implications for teacher development. Teacher Education programmes require a focus for value education through content knowledge and pedagogical knowledge inclined towards values education (NCTE, 2009). Quality teaching acts as a potential tool to integrate content, teaching strategies and value-based education for students' holistic development alongside academic advancement. An aspirational teacher having zeal to bring a genuine transformation in society will utilise the adequate teaching resources to augment learning and fostering values in learners. Developing right attitude is key factor of imbibing values for well-balanced personality development. Praise and pat over the right act strengthen the moral character with an upright morale for leading a life full of human values.

Positive reinforcement develops public relationships and societal behaviour in an individual (MHRD, Govt. of India, 1998; Sahin, 2019; Yazdani et al., 2015). Short training/certificate courses on value education must be organised in schools and higher educational institutes to help develop conscience towards morality and humanity. Also, personality development programmes can be organised in summer vacations in schools to disseminate the values among learners and transcend the ways of becoming a respectable functional member of the society. Similarly, school students may be asked to write articles based on their insights, thoughts, imaginations on some titles like "Society: A mirror image of individuals", "Vices and Virtues", "Purity of heart and soul", "Power of truth", "World as a global village" and so on. This shall illuminate their thinking to see the outer world with an eye for justice and equality, morality, values, concerns, sensitivity, respect, responsibilities towards each other.



In a similar fashion, extempore, debates, role play, drama and seminars can be organised in annual functions of the educational institutes introducing a lesson focusing on values and its essence in life. In a pluralistic society like India with diverse traditions, beliefs, cultural practices, values education is debated relentlessly as a core discipline in Indian education system. Social change with vertical mobility has led continuous depletion of values from individual's behaviour and from society as well. Therefore, personal perspectives have to be regulated and introspected. Glass half filled with water may be seen as half-filled or half-emptied, eyes are different but perception is yours. The way we look into, influences our vision, attitude, choice etc. Hence, while teaching it is focused that students must gain insights into the content being taught, maintain their conceptual clarity to finally assimilate the positive values adhered with the knowledge attained. Value education is nothing but training of heart for developing right feelings and emotions with moral behaviour and virtues. According to (UNESCO, 2015), integration of sports in curriculum can fairly improve the inculcation of values among learners. Sports activities offer a platform for learning plethora of values like camaraderie and team-union, esprit-de-corps, impartiality, equality, discipline, mutual respect, inclusion and determination, thus acting as a cornerstone of any nation at the forefront of progression in the hands of civilised countrymen. Value Education Through Sports (VETS) amid active learning fortifies concentration, participation, cognition and a better sense of responsibility. It assists students to exhibit values through their actions outside the schools reflecting their self-confidence, moral uprightness and responsible behaviour in a symbiotic society of the contemporary world (UNESCO, 2015).

Conclusion

A society that lacks values in its education of children and youth and has not adapted to such a conceptualisation, is surely on a

regressive path towards the days in dark ages of history. The cognitive domain of value education is in the training the heart rather than the mind since its core lies in developing the right feelings and emotions in morally upright atmosphere and finally, emerging out after an ideal by imitation or learning by example. After all, the values can be caught but not taught is the cardinal point envisaged in value education. The analogy is like a poet where the value of beauty of nature is caught in his eyes through the nature itself instead of enforcing it upon him. The motto behind value education lies in the cultivation of essential values of high social and spiritual significance in human beings and mobilizing a civilisation where the actions are based on moral judgements taken in the right spirit of sustained national development. Human values are closely integrated with human life and education is a means to deliver this, transmitting them over generations after generations and sustaining a life enacted with every nobility of human conscience. The perspectives of value education in the world is wholly recognized and is undisputedly the greatest instrument of transforming the youths of the country into a more organised, morally reputable dutiful citizens prepared to perform on the global stage. The imprints and impacts of it set the background of a developed society which foresees the inculcation and preservation of its cherished values. Accordingly, the paramount role of values dissipated through education is to facilitate a national transformation by placing its knowledge and expertise at the disposal of the society to be harnessed for the common good. The value education is indeed an enterprising methodology inextricably linked with the development of values deeply impacting the socio-economic fabric of the nation as a whole. Devoid of the potential to nurture values, education loses its heart and soul. The constructs of a society and the nation at the forefront lie in shatters if it has no education and if education has no values like a garden in gloom, with no flowers and bloom.

References

- Adams, A. 2011. The Need for Character Education. *International Journal of Social Sciences and Humanity Studies*. Vol. 3, No. 2. pp. 23–32.
- Berkowitz, M.W. 2011. What Works in Values Education. *International Journal of Educational Research*. Vol. 50, No. 3. pp. 153–158. <https://doi.org/10.1016/j.ijer.2011.07.003>
- Bilgiler, S. and E. Arastirmalari. 2013. The Place and Importance of Values Education in 4th and 5th Grade Primary School Social Studies Textbooks. *Journal of Social Studies Education Research*. Vol. 4, No. 2. pp. 79–102.
- Bower, W.C. 1952. *Moral and Spiritual Values in Education : A Challenge to Every American. Social and Philosophical Foundations of Education*. 2. University of Kentucky Press LEXINGTON. Last retrieved April 25, 2020 from https://uknowledge.uky.edu/upk_social_and_philosophical_foundations_of_education/2
- Central Board of Secondary Education. 2012. *Values Education - A Handbook for Teachers*. Central Board of Secondary Education, Government of India, Shiksha Kendra, Delhi. Retrieved July 18, 2020 from <https://www.google.com/search?client=firefoxbd&q=Values+Education+A+Handbook+for+Teachers>
- Eskew, D.S. 2004. *Values Education in American Public Schools: An Overview with Implications for the Future*. University of Georgia.
- Farooq Shah, S., S. Rehman Ghazi,, D. Miraj-ud-din, S. Shahzad and I. Ullah. 2015. Quality and Features of Education in the Muslim World. *Universal Journal of Educational Research*. Vol. 3, No. 4. pp. 243–257. <https://doi.org/10.13189/ujer.2015.030401>
- Halstead, J.M. and M.J. Taylor. 1996. *Values and Values Education in Schools*. Falmer Press, Taylor & Francis, London.
- Hofer, M., S. Schmid, S. Fries, F. Dietz, M. Clausen and H. Reinders. 2007. Individual Values, Motivational Conflicts, and Learning for School. *Learning and Instruction*. Vol. 17, No. 1. pp. 17–28. <https://doi.org/10.1016/j.learninstruc.2006.11.003>
- Holdsworth, R. 2009. *Values Education and Quality Teaching The Double Helix Effect*. (Terry Lovat & R. Toomey, Eds.), Springer. Dordrecht: Springer Netherlands. <https://doi.org/10.1007/978-1-4020-9962-5>
- Hytten, K. 2015. Ethics in Teaching for Democracy and Social Justice. *Democracy & Education*. Vol. 23, No. 2. pp. 1–10.
- Jones, T.M. 2009. Framing the Framework: Discourses in Australia’s National Values Education Policy. *Educational Research for Policy and Practice*. Vol. 8, No. 1. pp. 35–57. <https://doi.org/10.1007/s10671-008-9058-x>
- Kay, J. 2006. Social and Moral Responsibility, 1–17 Retrieved December 12, 2019 from https://archive.org/details/social_and_moral_responsibility/page/n15/mode/2up.
- Lakshmi Vijaya V., M.P. 2018. Value Education in Educational Institutions and Role of Teachers in Promoting the Concept. *International Journal of Educational Science and Research*. Vol. 8, No. 4. pp. 29–38. <https://doi.org/10.24247/ijesraug20185>
- Ledden, L., S.P. Kalafatis and P. Samouel. 2007. The relationship between personal values and perceived value of education. *Journal of Business Research*. Vol. 60, No. 9. pp. 965–974. <https://doi.org/10.1016/j.jbusres.2007.01.021>
- Lovat, T.J. 2007. Values Education: The Missing Link in Quality Teaching and Effective Learning. In : George Isac; Sándor Zoltán Németh (Ed.). *Values Education and Lifelong Learning* (pp. 199–210). Dordrecht: Springer Nature. https://doi.org/10.1007/978-1-4020-6184-4_11
- Lovat, Terence. 2005. Values Education and Teachers’ Work: a Quality Teaching Perspective. *New Horizons in Education*. 112(May), 13.
- Lovat, Terence and N. Schofield. 2004. Values Education for all Schools and Systems: A Justification and Experimental Update. *New Horizons in Education*. 111, 4–13.
- Lovat, Terry and R. Toomey. 2009. *Values Education and Quality Teaching: The Double Helix Effect*. Springer. <https://doi.org/10.1007/978-1-4020-9962-5>
- McLean, C. 2012. The Yellow Brick Road: A Values Based Curriculum Model. *Nurse Education*

- in Practice*. Vol. 12, No. 3. pp. 159–163. <https://doi.org/10.1016/j.nepr.2011.11.002>
- Ministry of Human Resource Development. 1998. *NPE-1986, Programme of Action -1992*. Retrieved May 17, 2020 from http://mhrd.gov.in/sites/upload_files/mhrd/files/upload_document/npe.pdf
- Ministry of Human Resource Development. 2016. National Policy on Education 2016 Report of the Committee for Evolution of the New Education Policy. *Ministry of Human Resource Development*. 1–217. Retrieved May 25, 2020 <http://www.nuepa.org/New/download/NEP2016/ReportNEP.pdf>
- Ministry of Human Resource Development. 2020. *National Education Policy 2020: Government of India*. Last retrieved June 5, 2020 https://www.mhrd.gov.in/sites/upload_files/mhrd/files/NEP_Final_English.pdf
- Mondal, B.C. 2017. Inculcating Human Values among School Students through Effective Teaching. *Journal of Social Sciences*. Vol. 13, No. 2. pp. 102–107. <https://doi.org/10.3844/jssp.2017.102.107>
- National Council of Educational Research and Training. 2005. *National Curriculum Framework. New Delhi*. Retrieved March 20, 2020 <https://www.google.com/search?client=firefox-b-d&q=NCF+2005>
- National Council for Technical Education. 2009. *National Curriculum Framework for Teacher Education: Towards Preparing Professional and Humane Teacher*. Document Press, New Delhi. Retrieved June 7, 2020 <https://www.google.com/search?client=firefox-b-d&q=NCFTE+2009>
- Nuriman, N. and F. Fauzan. 2017. The Influence of Islamic Moral Values on the Students' Behavior in Aceh. *Dinamika Ilmu*. Vol. 17, No. 2. pp. 275–290. <https://doi.org/10.21093/di.v17i2.835>
- Rajya-Sabha, Parliament of India. 1999. 81st Report on Value-Based Education (Presented). Retrieved July 18, 2020, from <http://164.100.47.5/rs/book2/reports/HRD/81reportvbe.html>
- Sahin, U. 2019. Values and Values Education As Perceived By Primary School Teacher Candidates. *International Journal of Progressive Education*. Vol. 15, No. 3. pp. 74–90. <https://doi.org/10.29329/ijpe.2019.193.6>
- Stephenson, J. and M. Killeavy. 1998. Teaching Values Education in Schools: The Attitudes, Beliefs and Practices of Teachers in Schools in the Republic of Ireland and the United Kingdom - Pointers for the Future. *Citizenship, Social and Economics Education*. Vol. 3, No. 3. pp. 115–126. <https://doi.org/10.2304/csee.1998.3.3.115>
- Syarif. 2020. Building Plurality and Unity for Various Religions in the Digital Era: Establishing Islamic Values for Indonesian Students. *Journal of Social Studies Education Research*. Vol. 11, No. 2. pp. 111–119.
- Thomas, R.M. 1991. The Nature of Values Education in Southeast Asia. *Educational Resources Information Center (ERIC)*. 1–19.
- Thornberg, R. 2008. The lack of professional knowledge in values education. *Teaching and Teacher Education*. Vol. 24, No. 7. pp. 1791–1798. <https://doi.org/10.1016/j.tate.2008.04.004>
- United Nations Educational, Scientific and Cultural Organization. 2015. UNESCO “Building Peace in the Minds of Men and Women” Retrieved June 10, 2020, from <https://en.unesco.org/themes/sport-and-anti-doping/preventive-education>
- Yazdani, S., M.A. Lakeh, S. Ahmady, S.A. Foroutan and L. Afshar. 2015. Concept Analysis: Value based Curriculum. *Biomedical and Pharmacology Journal*. Vol. 12, No. 3. pp. 123–130. <https://doi.org/10.13005/bbra/1614>
- Zajda, J. 2014. Values Education. In D. Phillips (Ed.), *Encyclopedia of Educational Theory and Philosophy*. Thousand Oaks, Sage (in print).

Investigating Conceptual Changes and Difficulties in Learning Mathematics during the Transitional Phase from Arithmetic to Algebra

Abstract

The sequential nature of mathematics is well known, and prior knowledge makes it more prominent in the process of mathematical learning, especially in the phase when mathematics shifts from the basic concepts of arithmetic to algebra. While learning mathematics students start with the basic concepts of arithmetic and then proceed to further mathematical learning. Thus, these all are dependent on each other in a sequential pattern. This study tries to identify the main difficulties faced by students in this particular phase along with the intent to explore the transitional phase of mathematics. The present study was conducted with the aim to identify the difficulties faced by students in the learning of algebra. The study has also tried to identify its causes with the help of a process-based approach.

Keywords: Difficulties, Algebra, Transition

Introduction

In the present era teaching and learning of mathematics is an issue of debate across the whole teaching and learning of algebra. Teaching of algebra offers a serious challenge due to its problem solving and symbolic issues become a major concern in the transitional phase of learning mathematics (Subramaniam & Banerjee 2011).

This study was focused on the transitional phase of learning mathematics. Therefore, Grade VI was taken for the study. In our country, algebra is formally introduced for the first time in this grade and before this class no such introduction and exposure of algebra was given in the curriculum of mathematics. Since most of the students have come with their prior knowledge of arithmetic they have studied at the previous classes. Teaching Learning of mathematics is an issue which should always be taken for the research. In the present times researches have revealed that difficulty in learning algebra proves to be a barrier in the later stage of learning higher mathematics

(Bazzini and Tsamir, 2004; Subramaniam & Banerjee, 2004.) Since algebra is the gateway for higher mathematics, difficulties in algebra ultimately add to the difficulties (Sugiarti & Retnawati, 2019). Since algebra is introduced in Grade VI in our country, prior to this students have previous knowledge of arithmetic alone. Therefore, during this phase of transition from arithmetic to algebra, it becomes necessary to understand and which kind of difficulties have been faced by the students while learning. The present study is based on these fundamental issues, that is why are students not able to cope with the problems of algebra.

Concept and Concerns of the Transitional Phase of Mathematics

In the schooling system, the curriculum is designed with the intent to link the concepts to the maximum extent. The problems of learning in algebra arise not only due to its nature as well as traditional management of course and curriculum (Lodholz, 1990).

Various researches have shown that there is a gap between the arithmetic and algebraic knowledge and this gap creates serious problems in algebra learning (Pillay, Wilss & Boulton-Lewis, 1998). They have also suggested arithmetic and algebraic knowledge from a cognitive perspective in an effort to determine what constitutes a pre-algebraic level of understanding and also suggest a model for the transition from arithmetic to pre-algebra to algebra to prompt the students' understanding of algebraic knowledge.

According to Warren (2003), students' understanding of the associative law, commutative law, and addition and division as general processes when they have completed their primary school education. The understanding of all these related concepts have assisted in the successful learning of algebra during the transition phase from arithmetic to algebra. This discussion from makes a clear sense that after completion of primary education students understanding of basic arithmetical concepts has laid the strong foundation in the process of developmental stage of algebra have also supported the issues that during the transitional phase of the arithmetic to algebra, the identification of operators and variables with the dualities in equality (operator– equivalent) are also challenging task for the students along with the duality of zero and non-acceptance of the negative solution (Gallardo & Hernández 2005).

Research has reported that while attempting the questions of arithmetic and algebra students use a different approach. While in arithmetic students' approach can work from the known conditions and find intermediate numerical solutions to arrive at the solution to the problem, in algebra, they are faced with the challenge of understanding symbols and handling variables to arrive at a meaningful conclusion.

In India, the teaching of algebra generally follows arithmetic in the curriculum generally in class VI. Since in the learning of algebra, students' prior experience in primary school

arithmetic comes into play, therefore, it becomes necessary for the mathematics teacher and curriculum writer to understand the gap between the arithmetic and algebra. The present study is directly related to this issue that how students starts to learn and solve the various algebraic problems and which type of conceptual changes and difficulties they face during this transition phase of leaning mathematics and on the above ground the present study was taken.

Research Questions

1. What kind of conceptual changes have occurred during the transitional phase to algebra among Class VI students?
2. What are the difficulties faced by the students of Class VI while learning algebra?

Objective of the Study

1. To identify the conceptual changes among students of Class VI while learning algebra
2. To study the difficulties faced by the students of Class VI while learning algebra

Research Design

The present study uses the survey method to research the abovestated questions. This is a qualitative study, where the researcher has collected data to ascertain the students' difficulties in learning, with the help of a test. Furthermore, the researcher felt that face-to-face interaction would be the most beneficial method for data collection. Therefore, a focus group discussion was conducted with students. Each group comprised 5 students was done in terms of extracting the exact figure.

Sample

In the present study, a total of 170 students of Class VI from different CBSE board schools have been selected as a sample for the study.

Tools Used

In the present study, the researcher has developed two tools to collect data. Both the tools were self-constructed by the researcher. Since the study was primarily based on the difficulties in learning algebra, so the researcher has constructed a test in which different items like fill in the blanks, match the column, error identification, MCQ and process orientation were asked. This test contains 14 different types of questions on algebra of Class VI NCERT syllabus.

Overall, the aim of this is to examine the process-based solution of different types of questions and learning difficulties that had occurred in the transitional phase of learning algebra while shifting from the arithmetic.

The second tool constructed by the researcher was focus group discussion (FGD). This tool was prepared for obtaining the view points of the students and experiences regarding learning algebra and difficulties in learning algebra.

This tool contains 10 different open-ended questions related to the above. Validity of both the tools was established by experts in the field of education and mathematical education.

Description of the Tools

Diagnostic Test

Fourteen items comprising the Diagnostic Test (DT) such as open-ended questions, fill in the blanks type questions, match the following type questions, word problems, objective type question and question based on complete the growing patterns (reasoning), all items were process orientation questions (Carpenter & Levi 2000). Overall aim of this questionnaire was examine the process based solution of the different types of questions along with the conceptual changes that had been occurred in the transitional phase of learning algebra while shifting from the arithmetic (Lian & Yew 2012)

Item wise discussion of the test is presented in the Table 1.

Table 1

Question Number in DT	Content it Covers	Area which it Targets to Inspect	Key Mathematical Ability Required to Solve the Question
1.	Basic concept of constant and variables	Identification of variable and constant	Understanding the concept of constant and variables in addition to their differences in algebra
2.	Basic Structural understanding of figures	Structural arrangement	Ability to understand and execute the structural arrangement properly
3.	Equation	Formation of an equation with one variable	Ability to understand the word puzzle and formation of an equation
4.	Solving an equation for any variable	Solving an equation with one variable	Understanding the transposition rules, concept of sign change during the transposition and calculating the value of an unknown quantity

5.	Solving an equation for any variable with sign complexity	Solving an equation with one variable with more sign complexity	Understanding the difficult transpositions, concept of sign change during the transposition and calculating the value of an unknown quantity
6.	Solving an equation with same variables on the both side of the equation	Understanding of relationship between the operations and function	Understanding the concept of similar variable
7.	Solving an equation	Understanding of relation between the operations and function in a detailed process based structure	Ability to solve an more complex equation by using the understanding of the transposition and complex variable addition
8.	Variable addition and multiplication	Adding the same variables together and their multiplication	Understating of the variable addition and function of coefficient in its addition and multiplication
9.	Concept of coefficients	coefficients and its use in addition and solving the equation	Understating of the variable addition and function of coefficient in its addition and multiplication in more complex equations
10.	Word problem	Forming an equation of word problem and obtaining its solution	Thinking about word structure and applying mathematical generalisations
11.	Variable, constant, and expression	Difference between variable, constant, and expression	Understanding the concept of constant, variables and formation of expression in algebra
12.	Solving an equation	Solving an equation with particular value of an variable	Understanding the way to solve an equation for the particular value of variable, as well as putting the value of variable in an equation to solve
13.	Multiplication of different variables together	Understanding of the multiplication of variables ($a \times b$)	Ability to open brackets, and do the multiplication of different variables like $a \times b$ as well as making meaning of $a.b$ and $a \times b$
14.	Growing patterns	Understanding of Growing Patterns	Ability to understand, visualise and analyse the structure and patterns (pictorial-based reasoning)

Focus Group Discussion (FGD) Schedule

The second tool was also constructed by the researcher. This schedule was prepared for obtaining the viewpoints of students in order to know the way in which they want to learn algebra, their ideas regarding algebra, how they approach various kinds of problems

and their rudimentary understanding about the basic concepts of algebra. This schedule contains 10 open-ended questions related to the above concerns.

Data Analysis

Since data was obtained with the help of a Diagnostic Test and an FGD schedule, it was

qualitative in nature. Also, the data obtained with the help of a Diagnostic Test was based on the process-oriented responses. Therefore, a qualitative analysis of data obtained was done.

Findings of the Study

Findings related to objective 1

Analysis of the conceptual changes and difficulties was done with the help of a Diagnostic Test and supported by the responses of the students on FGD.

The conceptual changes that were identified from all the questions were classified in five broad categories.

Table 2

No.	Conceptual Changes
1.	Basic understanding of variables and their use in solving various equations
2.	Understanding of algebraic structure and knowledge of equation formation
3.	Understanding of the sequences and patterns
4.	Transposition and its use to solve equations (when the variables are involved)
5.	Use and understanding of growing patterns and generalisation of patterns

Basic understanding of variables and their use in solving various equations

Since students have previous knowledge of addition from arithmetic and other mathematical operations, it carries forward from there to algebra. This is quite natural, but algebraic operations are not as similar as arithmetic. Variable addition and its multiplication both have the different concepts. Students did not understand the concept of variable addition and multiplication and were unable to solve the questions. Overall, conceptual changes found under this heading are changes that occur in terms of understanding the variables,

students were not able to understand that how number acts with variables and the role of coefficient in variable addition and multiplication.

Understanding of algebraic structure and knowledge of equation formation

An analysis of the responses on the Diagnostic Test and FGD revealed that students misinterpreted every different letter to stand for a different number. They believed that different letters cannot take the same numerical value. Even students who are good at mathematics often struggle to solve word problems. To be able to form equations with the help of word, students are required to use the knowledge of algebraic structure and syntax. Conceptual change identified in this category: when words and letters are matched from left to right when transposing literal sentences to form algebraic expressions or equations students again after transposition mistake is handling the variables with constant.

Transposition and use of its rules of to solve various equations

Brackets are an essential component of mathematical notation in both arithmetic and algebra. However, algebra requires more flexible understanding of brackets. In arithmetic, brackets are generally used as a sign to indicate which operation is to be performed first. The order of operation plays a key role in simplifying expressions and equations.

Many students find it difficult to understand brackets in algebra. Therefore, students simply overlook it. To some students, parenthesis means just a cover of variables in algebra. This is another conceptual changes identified related to parenthesis, transposition and its use.

Use and understanding of growing patterns as well as in the context of the generalisation of patterns



Under this category, the difficulty that students face is related to understanding a pattern. As we know, the general arrangement of numbers is different as compared to structural arrangement. Here maximum students have used a good reasoning ability but, here students have to produce a general rule to express a relationship between different patterns. Along with this, generating a symbolic expression for the general term of patterns is also required. Therefore, as observed here too, there were conceptual changes as well as generalisation of patterns, which was misunderstood by students.

Findings Related to Objective 2

On the basis of the responses obtained by the students and its analysis, the difficulties faced by students have been classified into five major categories. These difficulties have been reported on the basis of the response and solution of the question given by the student in the test. These are broadly classified in five different categories.

1. Difficulties related to use of operator and symbols
2. Difficulties related to formulation of algebraic expression or equation
3. Difficulties related to understanding of variable and constant
4. Difficulties related to structural understanding of figures/growing patterns
5. Difficulties related to solving an equation

S. No.	Concept/ Topic	Difficulties Faced by Students
1.	Use of operator and symbols	Most of the students faced difficulty in understanding the concept of equal sign in an equation.
2.	Formulation of algebraic expression or equation from information presented in words	Question 3 and 10 primarily focused on this concept. Most of the students were unable to understand the information and form the equation on the basis of it.

3.	Difference between variable, constant, and expression	Most of the students suffered to identify the expression, but maximum students were able to identify the constant and variable.
4.	Basic structural understanding of figures / growing patterns	Here too, most students identified the structures and figures, and applied their reasoning to arrive at the conclusion, but in some cases, students misunderstood the question and were unable to recognise the patterns and solve it
5.	Solving an equation with same variables on the both side of the equation	Students struggled to understand the process to arrive at solutions.

Analysis of Responses of Students obtained through the FGD

Overall, the responses of students obtained through the FGD revealed that students have basic misconceptions regarding algebra. Apart from this, students have also reported that while solving most of the equations of algebra, they were confused when they had to deal with parenthetical elements like $(x + 7y)(x + 2)$. Another aspect of learning algebra which they reported was understanding the concept of variables and constant, especially the difference of operations on constant and variables.

During the discussion with students, the most important issue identified was that they felt a difference between algebra and arithmetic, and it was found that there was a kind of cognitive gap between the two branches of mathematics (significant issue of transitional phase of learning mathematics).

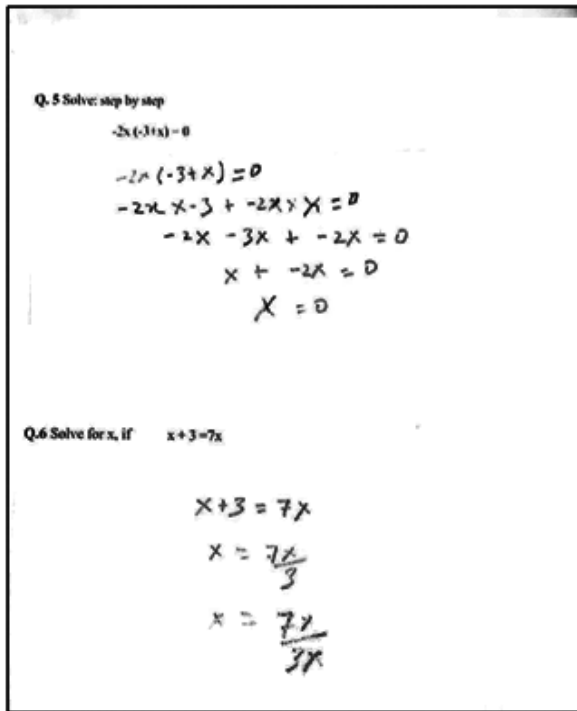

Fig. 1

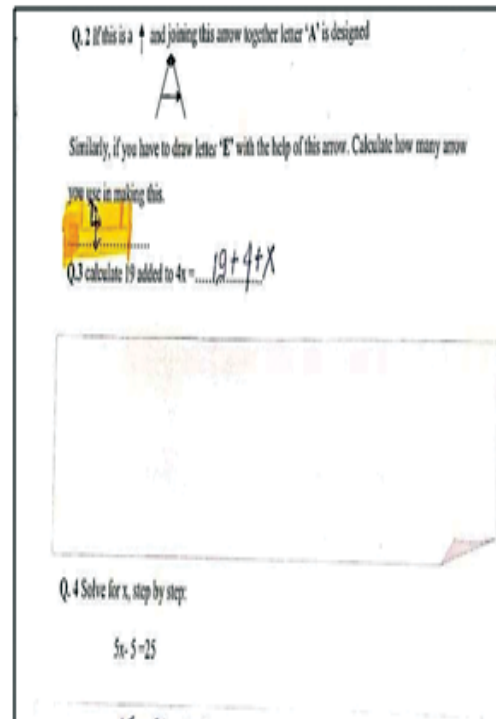

Fig. 3

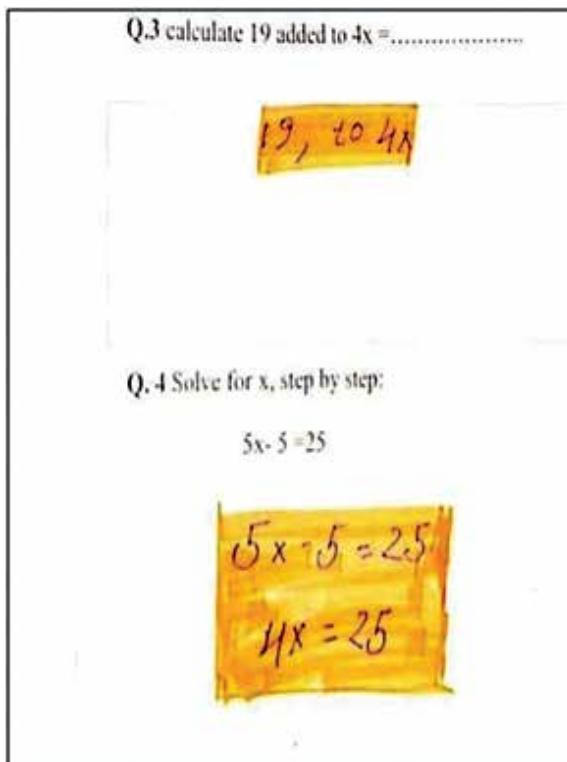

Fig. 2

Some key responses of the students

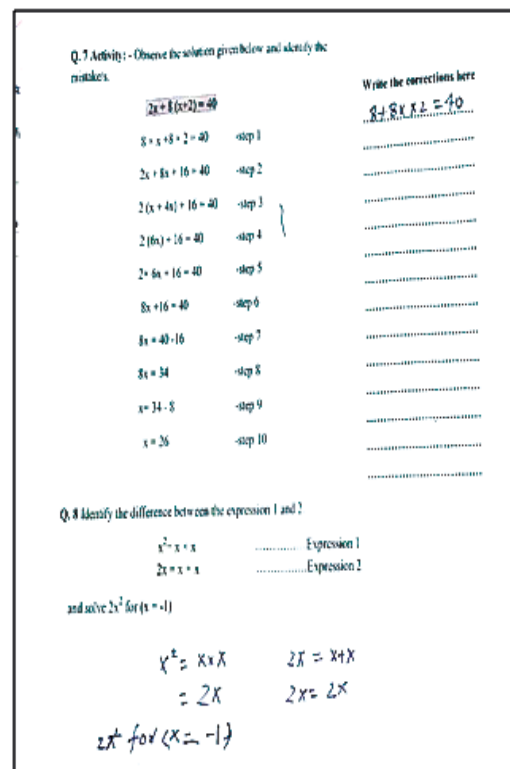

Fig. 4

Discussion

The findings of the study reveal that students have some major difficulties in learning algebra. Problems in learning algebra are not only due to the nature of algebra, but it also seems to be influenced by the conceptual changes occurring during this transitional phase. During the transitional phase from arithmetic to algebra, students have a basic understanding of arithmetic to handle algebra. These newly building concepts require algebraic thinking to cope up with this new learning situations (Blanton, M. et al. 2015, Subramaniam & Banerjee 2011). The recorded responses have also attracted attention towards the different types of difficulties faced by the students. These difficulties have occurred probably due to the symbolic nature of algebra and its abstractness. Few mistakes made by students were due to their arithmetic knowledge, which they have applied to handle the variables, constants and equations, understanding of word-problems and articulating them into the equation, which seems to be a major challenge for students.

Conclusion

Most of the students were facing the difficulty in understanding the concept of equal sign in an equation. Students have also suffered to identify the expression and use of transposition in an equation, but most of the students were able to identify constant and variable. Some difficulties were identified in

recognising the patterns and solving it, but most of the students were unable to solve the equation. Overall, process based questions have exposed difficulties related to the functional issue of operators while solving the various question of algebra (Koedinger & Terao, 2002). These issues can be kept in mind while developing a lesson plan and regular classes of algebra, especially at class VI level. At this level algebra appears to be a generalised form of arithmetic. Due to this, prior knowledge of arithmetic always plays a vital role in algebra learning. Since, the numbers are still used but their role are changed when dealing with the variables. Therefore, with the use of understating of symbols and way of its use along with constants and variables in the algebra becomes very prominent to be understood by the students.

Educational Implications of the Study

The findings of the present study can be utilised as:

- Diagnostic teaching can be developed on the basis of identified conceptual changes and difficulties.
- Teachers can use the result in their regular classroom teaching.
- The identified student's difficulties and conceptual changes in the transition phase of learning mathematics can be utilised to overcome the challenges of algebra learning.

References

- BAZZINI, L. AND P. TSAMIR. 2004. Algebraic Equations and Inequalities: Issues for Research and Teaching. In Proceedings of the 28th Conference of the International Group for the Psychology of Mathematics Education (pp. 152–155). Bergen, Norway.
- BEATTY, R. AND C. BRUCE. 2012. From Patterns to Algebra: Lessons for Exploring Linear Relationships. Nelson Education, Toronto, ON.
- BEST, JOHN W. AND JAMES V. KAHN. 2007. Research in Education (9th Ed.). Prentice Hall of India Pvt. Ltd., New Delhi.
- BOOTH, L. 1988. Children's Difficulties in Beginning Algebra. In A. Coxford (Ed.), The Ideas of Algebra, K–12 (pp. 20–32). National Council of Teachers of Mathematics, Reston.
- CAI, J. 2004. Developing Algebraic Thinking in the Earlier Grades: A Case Study of the Chinese Elementary School Curriculum. *Mathematics Educator*. Vol. 8, No. 1. pp. 107–130.
- CAI, J. AND E.J. KNUTH. 2005. Introduction: The development of students' algebraic thinking in earlier grades from curricular, instructional and learning perspectives. *ZDM-The International Journal on Mathematics Education*. Vol. 37, No. 1. pp. 1–4.
- Carpenter, T.P. and L. Levi. 2000. Developing Conceptions of Algebraic Reasoning in the Primary Grades. Res. Rep. 00-2) . National Center for Improving Student Learning and Achievement in Mathematics and Science, Madison, WI.
- Gallardo, A. and A. Hernández. 2005. The Duality of Zero in the Transition from Arithmetic to Algebra. *International Group for the Psychology of Mathematics Education*. 3 , pp. 17–24.
- KIERAN, C. 1992. Learning and Teaching of School Algebra. In D.A. Grows (Ed.), Handbook of Research on Mathematics Teaching and Learning (pp. 390–419). Macmillan, New York.
- . 2004. Algebraic Thinking in the Early Grades: What is It? In *The Mathematics Educator*. Vol. 8, No. 1. pp. 139–151.
- Koedinger, K.R. and A. Terao. 2002. A Cognitive Task Analysis of Using Pictures to Support Pre-algebraic Reasoning. In Proceedings of the Annual Meeting of the Cognitive Science Society 24 (24).
- LIAN, L.H. AND W.T. YEW. 2012. Assessing Algebraic Solving Ability: A Theoretical Framework. *International Education Studies*. Vol. 5, No. 6. pp. 177–188.
- LODHOLZ, R.D. 1990. The Transition from Arithmetic to Algebra. *Algebra for Everyone*. pp. 24–33.
- PILLAY, H., L. WILSS AND G. BOULTON-LEWIS. 1998. Sequential Development of Algebra Knowledge: A Cognitive Analysis. *Mathematics Education Research Journal*. Vol. 10, No. 2. pp. 87–102.
- SUBRAMANIAM, K. AND R. BANERJEE. 2011. The Arithmetic Algebra Connection: A Historical Pedagogical Perspective. In Jinfa Cai and Eric Knuth (Eds.), *Early Algebraization* (pp. 87–107). Springer, New York.
- SUGIARTI, L. AND H. RETNAWATI. 2019. Analysis of Student Difficulties on Algebra Problem Solving in Junior High School. In *Journal of Physics: Conference Series*, IOP Publishing. Vol. 1320
- USISKIN, Z. 1988. Conceptions of School Algebra and Uses of Variable. In A.F. Coxford and A.P. Shulte (Eds.), *The Ideas of Algebra, K-12 1988 Yearbook of the National Council of Teachers of Mathematics* (pp. 8–19). NCTM, Reston, VA.
- WARREN, E. 2003. The Role of Arithmetic Structure in the Transition from Arithmetic to Algebra. *Mathematics Education Research Journal*. Vol. 15, No. 2. pp. 122–137.

Dr. R. Suryakala, Assistant Professor
rskmapril2010@gmail.com

Research Productivity of Teacher Educators

Abstract

Research is an effort to bridge theory with practice. It also helps in refining the existing practices. Research must be an integral part of the Teacher Educators' work as educational research has a trickle-down effect that leads to quality at all levels of education. This article documents the research productivity of Teacher Educators and the factors affecting their research productivity. The findings reveal the research productivity of a sample of teachers in Thoothukudi district, Tamil Nadu tabulated on a scale prepared for measuring engagement with research. The findings also throw light on the factors that impact the research productivity of Teacher Educators.

Keywords: Research productivity, Teacher Educators

Introduction

The landscape of higher education in the country has been changing tremendously in recent years with significant implications for the work to be done by its faculty members. Higher education teachers are expected not only to deliver lectures in the classroom but to take up research, extend services to the community and more recently, also be familiar with digital pedagogic tools. There has been a sharp increase in the number of private institutions in higher education and there is a noticeable difference in the way teachers perform their roles in private, aided and government institutions. With the growing emphasis on accreditation, global demands on higher education and opening up of the higher education sector to global players, the role of the faculty members keeps transforming every day.

Teacher Education in India is the responsibility of the Department of Education in universities and Teacher Education colleges. Teacher Education has witnessed significant changes in the last decade. NCTE, the chief regulatory

body for Teacher Education institutions, notified revised regulations and norms and standards in 2014. Composite Teacher Education institutions, introduction of four-year integrated programmes, introduction of the B.Ed.-M. Ed. integrated programme and increase in the duration of B. Ed. and M. Ed. programmes to two years were the key features of the revised regulations. There was a change in the accrediting body of Teacher Education institutions from NAAC to QCI in the year 2017 with the development of a new framework for ranking and accreditation. NAAC has now once again taken up accreditation of Teacher Education institutions. All these changes have reverberations on the expected roles of Teacher Educators in universities and colleges of Education.

A rumination of how the role of Teacher Educators in colleges and universities is different from other college and university teachers becomes essential at this point. The minimum qualification for a college or university teacher is a postgraduate degree and National Eligibility Test qualification. To become a Teacher Educator, an additional

post-graduation in Education is required as the Teacher Educator is expected to have not only a strong foundation of a discipline but also a foundation in pedagogy to teach the discipline. The Teacher Educators engage those aspiring to become teachers in planning and implementing instruction in the classroom. In order to prepare teachers, they have to base their knowledge of behavioural sciences to strengthen the conceptual understanding and pedagogical skills of prospective teachers. With continuous and radical transformations in teaching and learning, Teacher Educators have to be involved in research and development activities for better training of prospective and practicing teachers. The research of Teacher Educators may seem to be easy compared to the pure research being done in laboratories. This does not mean that their research is of lesser importance. The research of Teacher Educators has the potential of redefining the way we teach and learn all other disciplines. The scope for community engagement is greater for Teacher Educators as they are engaged not only in guiding and improving school practices but also networking with other informal agencies of education and creating ripples of changes in the society at large. Reflective practice, empirical investigations and action research are more ways in which a teacher educator's engagement with research can be described.

Faculty members with greater volume of research activities are often admired by other faculty and students as being on the cutting edge of their field and are regarded as knowledgeable about recent trends in their field. These faculty members are seen as powerful educators and often serve as a frame of reference for others who are interested in research. Growing trends in research tend to be multidisciplinary drawing inputs from different disciplines. There is a burgeoning interest in STEM-based research worldwide, including our country. The role of university education departments is greater with regard to the quantum of research in Teacher Education.

Those working in universities are driven by the "publish or perish" culture borrowed from the western world. Since scholarly activities and research productivity are used to measure the success of universities, the Teacher Educators from universities prioritise research among other academic responsibilities. With the introduction of new aspects for career advancement that include e-content development and MOOCs, university teachers show interest in relating these to research.

The accreditation framework for colleges of Teacher Education and university Education departments vary in terms of weightage given to research. More weightage for research is given to university departments and the need for research work in colleges of Teacher Education has been stressed recently for a better institutional score. Given the predominance of teaching, practicum components and intensive teaching practice, colleges of Teacher Education find it hard to find time for research related activities. Being pulled in different directions, it is challenging for colleges of Education to satisfy all the requirements of the accreditation framework and the one that is all the more demanding is research.

Research Competence and Research Productivity are two aspects that gravitate greater attention. Research Competence refers to the possession of knowledge and skills for doing research. Research competence is a prerequisite for any kind of research activity. A competent researcher makes use of research knowledge and skills to formulate questions and seek answers that either explain the existing realities or find ways to improve the existing conditions. Research performance refers to the accomplishment of the set goals of the research being pursued. Research performance is usually used interchangeably with research productivity to refer to the quality and quantity of research outputs. (Li Bai, 2010). Although there are different operational definitions of research productivity, the majority of studies measure research productivity in terms of



research publications. Research productivity is, therefore, a more tangible manifestation of research work in the form of research outputs like publications, research grants and patents. The research competence, performance and productivity of Teacher Educators are variables that need to be explored.

Scholarly work of Teacher Educators in the form of research products is imperative as it not only enhances individual and institutional reputation but also serves as a precondition for quality in education at large. The research outputs of Teacher Educators serve to bring in changes in the entire education system of the country and its benefits trickle down to all levels of education. The Interim Report of the British Educational Research Association and The Royal Society for the Encouragement of the Arts, Manufacturing and Commerce (2014) explains that education systems such as those in Singapore and Finland that consistently 'come out on top' develop capacity from the bottom-up, and rely heavily on methodologically rigorous, research-based knowledge to inform their practice. Smith (2015) argues that practice-oriented research by Teacher Educators, which is useful to the practice field and can lead to changes in schools and Teacher Education, is of great relevance to the Teacher Education community, school teachers and leaders, and policymakers. Therefore, understanding the research ecosystem that prevails in the Teacher Education system needs greater attention in our country.

Review of Related Literature

There are a number of studies done to explore the research productivity of the faculty in higher education systems of different countries. The studies that have been undertaken have focussed on two areas: development of models to assess and conceptualise research productivity of academics and examination of predictors or factors that relate to research productivity of academics.

Bezley (2010) built a conceptual model of research performance by collecting data from a structured survey in which academics elaborated on eight different attributes of high-performing researchers. The data from 295 teaching academics from Australian universities were analysed using NVivo software and a conceptual model of research performance was proposed. Research performance was seen to comprise two basic components, with six secondary level dimensions and a range of potential indicators. Four essential (necessary and sufficient) dimensions, relating to the research activity component of research performance were: engagement, task orientation, research practice and intellectual processes. Two alternative dimensions (of which at least one is necessary) relating to the performance, or making research visible, component of research performance were: dissemination and collegial engagement. Research performance was seen to occur within conditions provided by an institutional context (education and training; opportunity and resources), and to bring about a range of outcomes (product, impact and reputation).

Jung (2012) studied the faculty research productivity in Hong Kong across academic disciplines. The individual and institutional factors that contribute to productivity and compare determinants of productivity across academic disciplines were explored. Data were taken from The Changing Academic Profession (CAP) project conducted in 2007. It was found that Hong Kong academics were highly internationalised in terms of research activities. Moreover, research productivity was influenced by a number of factors, including personal characteristics, workload, differences in research styles, and institutional characteristics. In addition, considerable variation existed regarding the determinants of research productivity across disciplinary categories.

Gilavand (2017) analysed the research productivity of Humanities faculty members in universities of Ahwaz, Southwest of Iran. The data was collected from a sample of

100 faculty members through a researcher made questionnaire. The research score was derived from the data based on Regulations for the Promotion of the faculty members of the Educational and Research Institutions, No. 8727.9.15.89 dated 22.2.2011 in Iranian Ministry of Science, Research and Technology. The research productivity was then calculated by dividing the research score by the number of years of service. The mean index of research productivity of humanities faculty members employed at universities of Ahvaz was 9.94 and the median was 7.30, indicating that the research point of 50 per cent of the faculty members was less than 7.30 annually. There was a significant difference among different groups of faculty members in terms of academic degree and academic rank. However, there was no significant difference between them in terms of gender, the university employed at and length of service.

Nasser-Abu Alhija & A. Majdob (2017) examined the relationship between Teacher Educators' research productivity and their background and professional characteristics, attitudes, motives, obstacles and time devoted to research. The sample included 161 Teacher Educators from four Teacher Education colleges in Israel. The volume of RP was calculated using a combination of Fox's (1992) formula and the weights proposed in HLS/APT (2000) guidelines. A questionnaire with subsections to measure Teacher Educators' attitudes towards research, motives for engaging in research and perceptions of obstacles to practicing research. The findings indicate the significance of five variables for predicting research productivity: academic degree, rank, administrative position, desire to develop new knowledge and learn from research findings and perceived insufficient research competence and self-confidence.

The present study focuses on the development of an index to measure research productivity of Teacher Educators and also to ascertain the personal factors and environmental factors that affect research productivity of Teacher Educators.

Need for the Study

Teaching in higher education includes four components namely teaching, evaluation, research and extension. Of these the teaching and evaluation components are taken care of adequately in Teacher Education institutions. The extension component receives a certain degree of attention as it has been a criterion of accrediting bodies. The research component, although being a criteria for accreditation, remains poorly attended to, especially in colleges of education. This is primarily because Teacher Educators in colleges of education find it hard to take up research with limited resources at their disposal. It poses a challenge for them to make visible any research that they do amidst their teaching, training and administrative loads. The research publications of Teacher Educators, especially those working in colleges, are fewer and very few Teacher Educators publish papers in journals of national and international repute. A culture of research is the missing element in Teacher Education colleges. An enquiry into the factors that contribute to the research productivity is required to strengthen the research component. Therefore, the study of the factors affecting the research productivity of Teacher Educators is intended by the researcher.

Operational Definition of the Key Terms

Research Productivity

It is defined in terms of the research product and research effort a researcher produces (Williams, 2003). In this study, research productivity refers to the number of research degrees, research publications, research guidance and research projects of a researcher.

Teacher Educators

It refers to the faculty working in the department of Education in universities, affiliated colleges of Teacher Education and

District Institutes of Education and Training. In this study, Teacher Educators refer to faculty of colleges of education.

Objectives of the Study

1. To find the research productivity of Teacher Educators
2. To ascertain the factors affecting the research productivity of Teacher Educators

Methodology

For the purpose of conducting this study, the survey method was used which attempts to describe the prevailing conditions. The population of the study was Teacher Educators from Thoothukudi district in Tamil Nadu. Stratified random technique was employed. The population was divided into strata on the basis of aided and private colleges in the district. Sixty-four Teacher Educators from Thoothukudi district formed the sample.

Research Tools

1. The following tools were used for the study:
2. Research Productivity Index

Factors Affecting Research Productivity Scale

Both the tools were developed by the researcher. The Research Productivity Index was developed on the following dimensions namely research degrees, research publication, research projects and research guidance. Generally, research productivity is measured in terms of publications. There are many other efforts put forth by academics for research purposes. In order to take into account all those largely invisible dimensions, research degrees, research projects and research guidance have also been considered. As research publications and research projects are matters of individual and institutional prestige, they are given higher scores than research degrees and research guidance. The weightage given to the various dimensions of the Research Productivity Index are as follows:

Table 1: Dimensions of Research Productivity Index

S. No.	Dimensions of Research Productivity Index	Weightage
1	Research degree	2
2	Research publication	3
3	Research projects	3
4	Research guidance	2
	Total	10

The description of the weightage given to different research degrees is as follows:

Table 2: Weightage to Research Degrees

S. No.	Research Degree	Status of Research Degree	Score
1	M.Phil.	Completed	0.25
2	M.Phil.	Pursuing	0.10
3	Ph.D.	Completed	0.75
4	Ph.D.	Pursuing	0.35
5	Post-doctoral	Completed	0.75
6	Post-doctoral	Pursuing	0.35
7	Any Other	Completed	0.25
8	Any Other	Pursuing	0.10

Doctoral and postdoctoral degrees are given more weightage than M. Phil and other degrees like Post Graduate Diploma in Higher Education (PGDHE) that require completion of a research project.

The description of the weightage given to research publications is as follows:

Table 3: Weightage to Research Publications

S. No.	Type of Publication	No. of Publication	Score
1.	Regional refereed	Less than 5 5 to 10 Above 10	0.3 0.4 0.5

2.	National refereed	Less than 5 5 to 10 Above 10	0.5 0.6 0.75
3.	International refereed	less than 5 5 to 10 Above 10	1 1.2 1.5
4.	Seminar/ Conference Proceeding	Less than 5 5 to 10 Above 10	0.15 0.2 0.25

Publications in International Refereed journals are given the highest weightage as they make the research more visible. Publications in seminar/conference proceedings are given lesser weightage.

The description of the weightage give to research projects is as follows:

Table 4: Weightage to Research Projects

S. No.	Projects	No. of Proj-ects	Score
1.	Completed/ ongoing	Less than 3 3 to 6 Above 6	2 2.5 3

The weightage is greater for more research projects.

The description of the weightage given to research guidance is as follows:

Table 5: Weightage to Research Guidance

S. No.	Level/Degree for which research is guided	No. of scholars guided / being guided	Score
1.	Post Graduate (M.Ed.)	less than 5 5 to 10 Above 10	0.1 0.2 0.25
2.	M.Phil	less than 3 3 to 6 Above 6	0.5 0.6 0.75
3.	Ph.D.	Less than 3 3 to 6 Above 6	0.6 0.8 1.0

The weightage for Ph.D. research guidance is greater as it requires more time and effort.

A maximum score of 10 could be obtained in the Research Productivity Index.

Factors Affecting Research Productivity Scale consisted of 18 statements, 9 each for the dimensions personal factors and environmental factors. The personal factors covered the following aspects:

- Research Knowledge
- Research Skills
- Research Confidence
- Time for Research
- Research Interest
- Motivation
- Statistical Knowledge
- Expert Advice
- Data Collection Assistance

The environmental factors covered the following aspects:

- Administrative Responsibility
- Research Culture
- Institutional Support
- Research Funds
- Resources
- Teaching Load
- Monetary Benefits
- Research Workshops
- Research Performance Assessment

Each of the items in the scale was responded to on a four-point scale that expressed the occurrence of the factors.

Results

Research Productivity of Teacher Educators

Table 6: Research Productivity Index of Teacher Educators

Score Category	Number	Percentage
Low (below 4)	47	73.4
Moderate (4 to 6)	13	20.3
High (Above 6)	4	6.3
Total	64	100

Personal Factors Affecting Research Productivity of Teacher Educators

Table 7: Personal Factors Affecting Research Productivity

S. No.	Personal Factors	Degree of Favourable Affect							
		To a great extent		To a certain extent		To a small extent		Not at all	
		N	%	N	%	N	%	N	%
1.	Research Knowledge	24	37.5	22	34.38	15	23.44	3	4.69
2.	Research Skills	2	3.13	18	28.13	25	39.06	19	26.69
3.	Research Confidence	26	40.63	17	26.56	18	28.13	3	4.69
4.	Time for research	11	17.19	18	28.13	22	34.38	13	20.31
5.	Research Interest	7	10.94	9	14.06	26	40.63	22	34.38
6.	Motivation	11	17.19	24	37.5	22	34.38	7	10.94
7.	Statistical Knowledge	19	26.69	24	37.5	15	23.44	6	9.38
8.	Expert Advice	2	3.13	20	31.25	19	29.69	23	35.94
9.	Data Collection Assistance	26	40.63	23	35.94	9	14.06	6	9.38

Environmental Factors Affecting Research Productivity of Teacher Educators

Table 8: Environmental Factors Affecting Research Productivity

S. No.	Environmental Factors	Degree of Favourable Effect							
		To a great extent		To a certain extent		To a small extent		Not at all	
		N	%	N	%	N	%	N	%
1.	Administrative Responsibility	7	10.94	16	25	27	42.19	14	21.88
2.	Research Culture	21	32.81	19	29.69	16	25	8	12.5
3.	Institutional Support	1	1.56	12	18.75	14	21.88	37	57.81
4.	Research Funds	10	15.63	16	25	19	29.69	19	29.69
5.	Resources	3	4.69	10	15.63	13	20.31	38	59.38
6.	Teaching Load	19	29.69	22	34.38	16	25	7	10.94
7.	Monetary Benefits	15	23.44	21	32.81	14	21.88	14	21.88
8.	Research Workshops	28	43.75	18	28.13	12	18.75	6	9.38
9.	Research Performance Assessment	6	9.38	16	25	16	25	26	40.63

Findings

- 73.4 per cent of Teacher Educators have low research productivity, 20.3 per cent of them have moderate and 6.3 per cent of them have high scores on research productivity.
- The personal factors that are perceived to positively affect research productivity to a great extent are research confidence and data collection assistance. The personal factors perceived by Teacher Educators to be the least favourable are research interest and lack of expert advice.

3. 'Opportunities to participate in research workshops' was the environmental factor that was perceived to be favourable to a great extent by Teacher Educators. 'Resources for research' and 'institutional support' were the environmental factors that were perceived to be least favourable by Teacher Educators.

Interpretation

73.4 per cent of Teacher Educators have low scores in their research productivity. This is due to the helplessness of Teacher Educators in colleges of education who are burdened with many professional responsibilities that leave them with little or no time for research. They also have limited or no access to digital resources for research. Moreover their limited exposure to emerging trends in research places them in a disadvantaged position in terms of research productivity. There are very few private colleges of education that promote a culture of research and majority of them are obsessed with admission and fee collection and it is pathetic to find teachers being engaged in promotional activities. The finding that research productivity of Teacher Educators is low supports the finding of Nasser M. Fadia, Alhija Abu, Majdob Arin. (2017) that research output of Teacher Educators is negatively skewed.

The personal factors that positively affect the research productivity of Teacher Educators to a great extent are research knowledge, research confidence and assistance for data collection. The finding that research confidence positively affects the research productivity of Teacher Educators supports the research conducted by Kotrlik, Bartlett, Higgins and Willaims (2002) in which they reported that research confidence explained a major proportion of the variance in faculty research productivity. Teacher Educators have research knowledge and confidence but lack in research interest and research skills. Moreover the non-availability of expert advice while engaged in research makes them disinterested to do research.

The environmental factors that positively affect the research productivity of Teacher Educators to a great extent are opportunities to participate in research workshops and a research culture in Teacher Education institutions. Although there are a number of educational research workshops conducted for Teacher Educators, the institutions do not provide enough infrastructural resources and support to apply the knowledge gained from such workshops. Although a culture of research seems to be present in government Teacher Education colleges and a very few private Teacher Education colleges, the research carried out is often for the sake of career advancement and better job prospects and the real purpose of educational research becomes lost in the race for better career status. The research culture if not supported with supportive practices will lead to decreased research productivity. This is stressed by Griffith, Thompson and Mryniewicz (2009) who reported that there was a need for entitlement to and protection of research time and a range of supportive measures to develop the research identities of Teacher Educators. The findings of this study also indicate that institutional support and resources are not perceived as favourable to research productivity. This is similar to one of the findings by Nasser M. Fadia, Alhija Abu, Majdob Arin. (2017), who reported that Teacher Educators rated lack of resources to be the highest obstacle to research productivity.

Conclusion

The investigation shows that the research productivity of Teacher Educators is low. This shows that the research component has to be strengthened in all Teacher Education colleges. Teacher Education colleges should strive to establish a culture of research where research is done with an intention to contribute to societal development. The impact that educational research can make in terms of policy making and research-informed teaching should be made known to the Teacher Educators. An orientation on



research must be given to the new entrants and the experienced Teacher Educators must share their knowledge in research with the newly recruited Teacher Educators and encourage them to take up research work. It is high time that Teacher Education colleges realise the need for research activities to maintain the standard of Teacher Education institutions in India.

The institutional support for research of Teacher Educators has to be strengthened in Teacher Education colleges. Infrastructural

resources have to be improved for research activities. Library resources for research has to be paid more attention and expert advice must be made available for research. The administrative responsibilities of Teacher Educators have to be reduced so that they get more time for research. Efforts must be made to foster the research interests of Teacher Educators so that research in education can revolutionize the ways in which teaching and learning is being carried out in educational institutions.

References

- Bezley, P. 2010. Conceptualizing Research Performance, *Studies in Higher Education*, 35(8), 889-903
- British Educational Research Association Interim Report. 2014. The Role of Research in Teacher Education: Reviewing the Evidence, Retrieved from <https://www.thersa.org/globalassets/pdfs/reports/bera-rsa-interim-report.pdf>
- Fadia, Nasser M., Abu,Alhija, Arin, Majdob . (2017), Predictors of Teacher Educators' Research Productivity, Volume 42, (Issue 11). Retrieved from <http://dx.doi.org/10.14221/ajte.2017v42i1123>
- Griffith, Thompson, Hryniewicz. 2009. Developing Research Identities: Effective Mentoring for Teacher Educators, Summary of paper presented at the British Educational Research Annual Conference, University of Manchester. Retrieved from http://www.leeds.ac.uk/bei/Education-line/browse/all_items/189278.html
- Jisun, J. 2012. Faculty Research Productivity in Hong Kong. Across Academic Disciplines. *Higher Education Studies*, Volume 2. (Number 4)
- Smith, K. 2015. The Role of Research in Teacher Education, *Research in Teacher Education*. Vol.5, No. 2. pp. 43-46
- Kotrlik, Bartlett, Higgins and Willaims. 2002. Factors Associated with Research Productivity of Agricultural Education Faculty. *Journal of Agricultural Education*. Vol. 43, No. 3. pp. 1-10
- Li Bai. 2010. Enhancing Research Productivity of TEFL Academics in China. Centre for Learning Innovation, Queensland University of Technology. Retrieved from https://eprints.qut.edu.au/41732/1/Li_Bai_Thesis.pdf
- Mohammad Hosseinpour and Abdolreza Gilavand. 2017. Analysing Research Productivity of Humanities Faculty Members in Universities of Ahvaz, Southwest of Iran, *Indo American Journal of Pharmaceutical Sciences*. Vol. 4, No. 09. pp.

Two Decades (1999–2018) Of Research Studies In Teacher Education Through Open And Distance Learning

This study explores the two decades of publication of research articles related to Teacher Education through Open Distance Learning in research journals of distance education and find out the type of delivery modes used, frequency of delivery modes and the communication approaches it follows for the delivery of instructional activities. It further examines the research method, sampling techniques, tools for data collection used in the articles and also the authorship pattern of the articles. The study presented here is a basis towards understanding of the current level of research in the field of Teacher Education through ODL. Keywords: Teacher Education, Open and Distance Learning, Instructional activities, delivery modes, Communication approach, Synchronous learning approach, Asynchronous learning approach, Blended learning approach.

The short version of this paper was presented at national Seminar on conference on Teacher Education through Open and Distance Learning: Challenges and the Road Ahead' at New Delhi from March 27–29 2017 organised by School of Education, IGNOU.

Introduction

The Open and Distance Learning organisations cautiously look for the platforms and appropriate technology-based course delivery modes before launching any new course to cater its learners/users effectively. Heirdsfield, Davis, Lennox, Walker, & Zhang (2007) state that “rapid advances in technology have recently made access to higher education more readily available” (as cited in Amanda R. Hurlbut, 2018, p. 249). The purpose of this review is to put forth the current state and trends of research in the field of Teacher Education through open and distance learning and set future vision in front of the providers of Teacher Education through open and distance learning. To this intention the researcher conducted a review and identified the emerging delivery modes used for instructional activities, communication approaches followed for delivery of instructional activities, research method, sampling techniques and tools for data collection, and the authorship pattern of the articles of Teacher Education through open and distance learning. The comparison

of research articles is carried out to find the trends in Teacher Education through open and distance learning at national and international level.

There are many research topics related with review undertaken in the field of distance education. Mishra (1997) critically analysed the Open Learning, American Journal of Distance Education, Indian Journal of Open Learning, and Distance Education “to reveal the state and status of the subject and research activities on it.” Mishra (1998) reviewed the distance education research literature from the viewpoint of its structure, methodological concerns and priority areas. Mishra (2002) has reviewed the *Indian Journal of Open Learning* from Vol. 1 to Vol.10 (spanning 10 years) and found out the authorship pattern, leading contributors, country-wise and topic-wise distribution of papers, research method, data collection techniques and reference characteristics. Lee, Driscoll and Nelson (2004) have examined research topics, methods, and citation trends using content analysis. Zawacki-Richter, Backer & Vogt (2009) reviewed distance education research from 2000 to 2008 and

analysed the research areas, methods, and authorship patterns. Davies, Howell and Petrie, J. (2010) have explored and summarised trends in research in the topics addressed, research designs utilised, and data collection and analysis methods used in the area of distance education. Ritzhaupt et al. (2010) examined “distance education research by implementing a co-word analysis methodology to identify themes, trends, and structural characteristics in North American distance education literature.” Halverson et al. (2011) analysed the “*American Journal of Distance Education* between the years 2001 and 2010 and found out the trends in topics and categories, methodologies, authors, and word frequency in abstracts and titles.” All the above research reviews/studies have carried out in the area of distance education as a whole. This researcher has not come across the specific review of the articles related with the subject Teacher Education through open and distance learning. This study will put forth the current scenario and trends and set future vision in front of the providers of Teacher Education through open and distance learning.

Methodology

The content analysis technique is used for reviewing the research articles in the area of Teacher Education through Open and Distance Learning. For the purpose, one refereed journal of distance education published in India namely the *Indian Journal of Open Learning* (IJOL) and one refereed journal of distance education published in USA namely the *American Journal of Distance Education* (AJDE) available online in World Wide Web is chosen. All the research articles were studied to collect the required data. In total, 20 volumes of *IJOL* from 1999 (Vol. 08) to 2018 (Vol. 27) were reviewed and 276 published research articles were analysed. Similarly, 20 volumes of *AJDE* from 1999 (Vol. 13) to 2018 (Vol. 32) were reviewed and in total, 301 published research articles were analysed. The total number of samples from both the research articles was 577.

Keeping the research objective in mind to investigate the research articles related with Teacher Education (pre-service and in-service) through ODL the units were chosen. The articles which are directly related to Teacher Education or have studied any aspects of Teacher Education through ODL were selected. To minimise the possibility of exclusion of articles related with Teacher Education through distance education, the researcher scanned the title, abstract, participants, data collection and sampling part of the articles and included the article if it relates to the teacher/faculty/academic education. The articles related with other professional training programmes, doctoral programmes or general education courses are not included in this review.

These selected articles were then classified into different categories. They are: the mode of delivery used for instructional activities, communication approaches followed for delivery of instructional activities, research method, sampling techniques and tools for data collection they used and the authorship pattern of the articles. The researcher used the same terminology/expressions of the delivery mode, communication approach, research method, sampling techniques used and tools for data collection as used by the author/authors in the title, abstract and methodology portion of the articles. While reviewing the article, if any of the above elements were specifically not mentioned or visible then it is reported as ‘Not Mentioned’ in the review.

The *IJOL* had a total of 32 research articles and *AJDE* had a total of 15 articles which fulfill the inclusion criteria related to Teacher Education through open and distance learning.

Analysis

Publication frequency of Articles

Table 1 shows that out of 577 research articles published from 1999 to 2018 in both the research journals *IJOL* and *AJDE*, 47

articles (8.14 per cent) are related to Teacher Education through ODL. Further, it can also be seen that *IJOL* (11.59 per cent) has published more research articles than *AJDE* (4.98 per cent) as far as the publication of research articles related to Teacher Education through ODL is concerned.

Table 1: Classification of Articles of *IJOL* and *AJDE* related to Teacher Education through ODL

Re-search Journal	Total no. of Articles Published	Frequen-cy (Teacher Educa-tion)	Per-centage (approx-imate)
<i>IJOL</i>	276	32	11.59
<i>AJDE</i>	301	15	4.98
Total	577	47	8.14

Delivery modes used

Out of 32 research articles of *IJOL* related to Teacher Education through ODL, only 12 articles (37.5 per cent approximately) have mentioned the delivery mode used in instructional process as per Table 2.

Table 2: Classification of Articles of *IJOL* in Different Delivery Modes Used

S.No.	Delivery Mode	Total article	Percent
1	Computer	1	3.12
2	ICT/education-al/ learning/ teaching tech-nology	1	3.12
3	Multimedia	1	3.12
4	Online/Web/Internet	5	15.62
5	Print	3	9.37
6	Tele-conference	1	3.12
Total		12	37.5

Table 2 shows that the delivery mode 'Online/ Web/Internet' has been used the most (5 articles) for instructional process as far as the articles related to Teacher Education through

ODL is concerned. The delivery mode 'print' is used in three articles for instructional purpose. The delivery modes computer, ICT, multimedia and teleconference also have their presence with 1 article each. From the above observation it can be said that at the national level, the provider of instructional activity for Teacher Education have given the priority to the delivery mode 'online/web/ internet' in comparison to 'print' or other delivery mode.

Table 3 shows that out of 15 research articles of *AJDE* related to Teacher Education through distance education, 14 articles (93.3 per cent) have mentioned the delivery mode used in instructional process.

Table 3: Classification of Articles of *AJDE* in Different Delivery Modes Used

S.No.	Delivery Mode	Total article	Percent
1	Online/Web/Internet	13	86.66
2	Virtual world/ LMS	01	6.66
Total		14	93.3

Table 3 shows that 13 articles have used 'online/web/internet' for instructional process and only one article has used the 'virtual world/LMS' mode for delivery of instructional process.

Communication approach

Table 4 shows that out of 12 articles (37.5 per cent approximately, N=32) of *IJOL* only 11 articles (91.66 per cent approximately, N=12) were found establishing communication approach.

Table 4: Articles of *IJOL* with Regard to Communication Approach

S. no	Delivery Mode	Synchro-nous	Asynchro-nous	Blended/ Mixed	Not men-tioned	Total ar-ticle
1	Com-puter	-	1	-	-	1

2	ICT/IT	-	-	-	1	1
3	Multi-media	-	1	-	-	1
4	On-line/ Web/ Inter- net	-	4	1	-	5
5	Print	-	3	-	-	3
6	Tele-conference	1	-	-	-	1
Total		1	9	1	1	12

Table 4 shows that out of 11 articles, the communication approach of delivery modes of 1 article (9.09 per cent) were synchronous, whereas the approach of the delivery mode of 9 articles (81.81 per cent) were asynchronous. Further delivery mode of 1 article (9.09 per cent) has the mixed or blended communication approach.

Table 5 shows that out of 14 articles (93.33 per cent approximately, N=15) of *AJDE* related with Teacher Education through distance education which mentioned the delivery mode used for instructional process, the communication approach is mentioned in 13 articles (92.85 per cent, N=14).

Table 5: Articles of *AJDE* with Regard to Communication Approach

S. No	Delivery Mode	Syn- chro- nous	Asyn- chronous	Blended/ Mixed/	Not men- tioned	Total article
1	Online/ Web/ Internet		6	6	1	13
2	Virtual world/ LMS			1		1
Total			6	7	1	14

Table 5 shows that out of 13 articles which mentioned the communication approach of delivery modes, 6 articles (46.15 per cent) were asynchronous and the communication approach of 7 articles (53.84 per cent) were blended/mixed.

Research Method

Out of 32 research articles of *IJOL* related to Teacher Education through distance education, only 25 articles (78.12 per cent approximately) have mentioned the research method used as per Table 6.

Table 6: Articles of *IJOL* with Regard to Research Method

Research Method	Frequency	Percentage (approximately) N=32
Descriptive	12	37.5
Survey	6	18.75
Experimental	3	9.37
Qualitative	2	6.25
Evaluative	1	3.12
Developmen- tal-cum-exper- imental	1	3.12
Total	25	78.12

It can be observed from Table 6 that out of 25 articles which have mentioned the research method, a majority of the research articles, that is 12 (48 per cent) have used the descriptive research method in the articles of *IJOL* related to Teacher Education through ODL. The survey research method has its presence in 6 articles (24 per cent) followed by the experimental design with 3 articles (12 per cent) and qualitative research method with 2 articles (8 per cent). The evaluative and developmental-cum-experimental research method is used in 1 article (4 per cent) each.

Table 7 shows that out of 15 research articles of *AJDE* related to Teacher Education through distance education, only 11 articles (73.33 per cent) have mentioned the research method.

Table 7: Articles of AJDE with Regard to Research Method

Research method	frequency	Percentage (approximately) N=15
Experimental/ quasi experimental	3	20
Qualitative	2	13.33
Quantitative	2	13.33
Descriptive	2	13.33
Evaluative	1	6.66
Developmental	1	6.66
Total	11	73.33

It can also be seen from Table 7 is that in AJDE out of 11 articles which mentioned the research method the experimental/quasi experimental research method is used in three articles (27.27 per cent) followed by qualitative, quantitative and descriptive method with two articles (18.18 per cent) each. The evaluative research and developmental research method has also showed its presence with one article each (9.09 per cent).

Sampling techniques

Out of 32 research articles of *IJOL* related to Teacher Education through distance education, only 15 articles (46.87 per cent approximately) have mentioned the sampling technique used in the research as can be seen in Table 8

Table 8: Articles of *IJOL* with Regard to Sampling Techniques

Sampling Techniques	Frequency	Percentage (approximately) N=32
Random sampling/ simple random sampling	9	28.12
Stratified random sampling	3	9.37

Purposive sampling	2	6.25
Systematic random sample	1	3.12
Total	15	46.87

It is also observed from Table 8 above that out of 15 articles which have mentioned the sampling techniques used in the articles, the researcher used the random sampling/simple random sampling techniques the most, that is 60 per cent (9 articles). Stratified random sampling technique is used in three articles (20 per cent), purposive sampling in two articles (13.33 per cent) and Systematic random sampling in only one article (6.66 per cent).

Table 9 shows that out of 15 research articles of *AJDE* related to Teacher Education through distance education, only 1 article (6.66 per cent) has mentioned the sampling technique used in the research article.

Table 9: Articles of *AJDE* with Regard to Sampling Techniques

Sampling Techniques	Frequency	Percentage (approximately) N=15
Criterion sampling	1	6.66
Total	1	6.66

Tools for data collection

Out of 32 research articles of *IJOL* related to Teacher Education through distance education, only 22 articles (68.75 per cent approximately) have mentioned the tools for data collection used in the research as can be seen in Table 10

Table 10: Articles of *IJOL* with Regard to Tools for Data Collection

Tools for Data Collection	Frequency	Percentage (approximately) N=32
Questionnaire/ structured questionnaire/ opinionnaire	10	31.25

Scale/standardised scale / reaction scale	2	6.25
Multiple-2 tools	3	9.37
Multiple- more than 2 tools	3	9.37
Interview	1	3.12
Test/test Items	3	9.37
Total	22	68.75

It can be seen from Table 10 that out of 22 articles which mentioned the tools for data collection, a major number of articles, that is 10 (45.45 per cent) of *IJOL* have used 'questionnaire' as a tool for data collection. Interestingly 6 articles (27.27 per cent) have made use of multiple tools, that is two or more than two tools for data collection.

Table shows that out of 15 research articles of *AJDE* related to Teacher Education through distance education, 14 articles (93.33 per cent) have mentioned the tools for data collection used in the research article.

Table 11: Articles of *AJDE* with Regard to Tools for Data Collection

Tools for Data Collection	Frequency	Percentage (approximately) N=15
Interview	2	13.33
Questionnaire	3	20
Online questionnaire	2	13.33
Document Analysis	2	13.33
Essays	1	6.66
Pre-test post-test	1	6.66
Multiple tools (Interview and questionnaire)	2	13.33
Social Network Analysis (SNA)	1	6.66
Total	14	93.33

It can be observed from Table 11 that out 14 articles of *AJDE*, which have mentioned the tools for data collection, five articles

(33.33 per cent) used the 'questionnaire/online questionnaire' tool in the research articles. Further, the researcher used other tools for data collection such as interview, document analysis and multiple (interview and questionnaire) tools in two articles (13.33 per cent) each. Essays, pretest post-test and social network analysis (SNA) tools are also used in 1 article each (6.66 per cent).

Authorship pattern

The authorship pattern of research articles of *IJOL* related to Teacher Education through distance education in Table 12 shows that single authors have contributed the major number of articles, that is 18 (56.25 per cent). There are 13 articles (40.62 per cent) contributed by 2 authors. Interestingly, there is 1 article (3.44 per cent) contributed by 5 authors.

Table 12: Authorship Pattern in *IJOL*

Number of Authors	Frequency	Percentage (approximately)
1	18	56.25
2	13	40.62
5	1	3.44
Total	32	100

The authorship pattern of research articles of *AJDE* related to Teacher Education through distance education in Table 13 shows that the articles contributed by single authors shares the space equally with the articles contributed by 2 authors with 4 articles (26.66 per cent) each. Three authors each have contributed 5 articles (33.33 per cent), whereas 2 articles (13.33 per cent) are authored by 4 authors each.

Table 13: Authorship Pattern in *AJDE*

Number of Authors	Frequency	Percentage (approximately)
1	4	26.66
2	4	26.66
3	5	33.33

4	2	13.33
Total	15	100

Result and Discussion

1. The data related to the publication frequency of research articles related to Teacher Education through ODL published at the national and international levels in distance education revealed that in total, both the research journals are giving adequate space (8.14 per cent) to the research articles related to Teacher Education through distance education. However, the *IJOL* (11.59 per cent) has far ahead from *AJDE* (4.98 per cent) in giving space to the research articles related to Teacher Education through ODL.
2. The data related to finding out the most used delivery modes in published research articles at the national and international levels for Teacher Education through ODL shows that out of 47 articles (32 articles in *IJOL* and 15 articles in *AJDE*), only 26 articles (55.31 per cent) have mentioned the delivery mode. However, research articles of *AJDE* with 14 articles (93.33 per cent) is far ahead from *IJOL* with 12 articles (37.5 per cent) mentioning the name of delivery mode. Almost all the articles of *AJDE* (14 out of 13) have used 'online/web/internet' delivery mode for Teacher Education through ODL. From the above observation, it can be said that at an international level the providers of instructional activities for Teacher Education are mostly using advanced delivery mode (in terms of technology and communication approach) with the help of new media technologies and the use of conventional delivery modes such as 'print', 'audio/video' 'CD/DVD', 'radio', 'television', etc. has declined drastically. However, at the national level, out of 12 articles of *IJOL*, 5 articles have used 'online/web/internet' which is followed by 'print' delivery mode with 3 articles. It can be ascertained from the analysis

that 'online/web/internet' is the most used (69.23 per cent) delivery mode for Teacher Education through ODL at the national and international level.

3. The data related to communication approach revealed that the providers of the instructional activity in published articles of *IJOL* related to Teacher Education through ODL preferred the asynchronous approach over synchronous or blended/mixed approach. Whereas in *AJDE* published articles related to Teacher Education through ODL used the asynchronous approach (6 articles) and blended/mixed approach (Using both synchronous and asynchronous approach) having 7 articles in it. It is also observed that asynchronous approach is the most used approach (62.5 per cent) at the national and international levels with 15 articles out of 24.
4. The data related to the research methods used revealed that the majority of the research articles, that is 12 in number, (48 per cent) have used the descriptive research method in the articles of *IJOL* related to Teacher Education through ODL. This result is consistent with other results reported. Mishra (2002) reported that descriptive method (34.12 per cent) was the major approach adopted in the papers published in *IJOL*. In his review of articles published between 1991 and 1996 in *AJDE*, *DE*, *JDE*, and the *Indian Journal of Open Learning*, Mishra (1997) reported a percentage of 47.6 per cent of descriptive papers. However, in the articles of *AJDE* the experimental/quasi experimental research method is used the most in 3 articles (27.27 per cent). This result is not similar to the result of Halverson et al. (2011) who have found the most frequently used methodology to be survey-based research, the method used in more than one-quarter (26.2 per cent) of the studies published by *AJDE*.
5. The data related to the sampling techniques used reveals that in the articles published in *IJOL* related to Teacher Education

through ODL, the researcher used the random sampling/simple random sampling techniques the most, that is 60 per cent (9 articles, N=15) whereas in *AJDE*, only 1 article (7.69 per cent) has mentioned the sampling technique used in the research article.

6. The data related with tools for data collection reveals that a majority of articles of *IJOL*, that is 10 (45.45 per cent) have used the 'questionnaire' as a tool for data collection. When compared, this result shows similarity with Mishra (2002) which reports that the use of questionnaire and scale was in 82.44 per cent cases in the articles of *IJOL*. Similarly, in research articles of *AJDE* researcher have used questionnaire/online questionnaire in 5 articles (33.33 per cent). In both the journals, a total 36 articles have mentioned the tools for data collection and majority of articles (41.66 per cent) have used 'questionnaire/online questionnaire' for data collection.
7. The data related to authorship pattern of research articles of *IJOL* reveals that the single authors have contributed the majority articles, that is 18 (56.25 per cent) whereas 14 articles (43.75 per cent) were contributed by multiple authors. This result demonstrates consistency with the results reported by Mishra (1997) single authors' contributions in Distance Education are more common (61.49 per cent). Mishra (2002) again reported that single authors have contributed 69.45 per cent of papers whereas multiple

authored papers constitute 30.55 per cent. The data related to authorship pattern of research articles of *AJDE* revealed that the majority of research articles, that is 11 in number (73.33 per cent) were contributed by multiple authors. This result is consistent with the result reported by Mishra (1997) that in *AJDE* multiple author papers constitute 53.75 per cent, indicating a trend in collaborative research.

Conclusion

An analysis of 20 years for *AJDE* and *IJOL* shows that both the research journals are giving adequate space to the research articles related to Teacher Education through distance education. 'Online/web/internet' is the most used delivery mode for Teacher Education through ODL at the national and international levels. It is also observed that asynchronous communication approach is the most used approach at the national and international levels for Teacher Education through ODL. At the national level, the trends for research is inclined towards a descriptive research method whereas experimental/quasi-experimental research method is used for Teacher Education at the international level. The random sampling/simple random sampling technique is used the most at the national level. 'Questionnaire/online questionnaire' is the preferred tool for data collection in *IJOL* and *AJDE*. Single authorship pattern is more prevalent in *IJOL* whereas *AJDE* is consistent in showing a trend towards collaborative research.

Reference and Bibliography

- Hurlbut, 2018. Online vs. Traditional Learning in Teacher Education: A Comparison of Student Progress. *American Journal of Distance Education*. Vol. 32, No. 4, pp. 248–266. Retrieved on 10-08-2020 from: <https://doi.org/10.1080/08923647.2018.1509265>
- Davies, R., S. Howell and J. Petrie. 2010. A Review of Trends in Distance Education Scholarship at Research Universities in North America, 1998–2007. *The International Review of Research in Open and Distance Learning*. Vol. 11, No. 3. pp. 42–56. Retrieved in 02-03-2017 from: <http://www.irrodl.org/index.php/irrodl/article/view/876>

- Halverson, Lisa R. Jay A. Bostwick., Shawn R. Cates & Richard E. West (2011). The American Journal of Distance Education, 2001-2010, Educational Technology/july-August 2011 retrieved on 02-03-2017 from: https://www.academia.edu/2538162/The_American_Journal_of_Distance_Education_2001-2010
- Lee, Y., M.P. Driscoll and D.W. Nelson. 2004. The Past, Present, and Future of Research in Distance Education: Results of a Content Analysis. *American Journal of Distance Education*. Vol. 18, No. 4. pp. 225–241. Retrieved on 12-12-14 from: http://dx.doi.org/10.1207/s15389286ajde1804_4
- Mishra. S. 1997. A Critical Analysis of Periodical Literature in Distance Education. *Indian Journal of Open Learning*. Vol. 6, No. 1&2. pp. 39–53. Retrieved on 01-03-2017 From: <http://journal.ignouonline.ac.in/iojp/index.php/IJOL/article/viewFile/235/134>
- Mishra, S. 1998. Distance Education Research: A Review of its Structure. Methodological Issues and Priority Areas. *Indian Journal of Open Learning*. Vol. 7, No. 3. pp. 267–282. Retrieved on 01-03-2017 from <http://journal.ignouonline.ac.in/iojp/index.php/IJOL/article/viewFile/226/125>
- Mishra, S. 2002. Ten Years of Indian Journal of Open Learning. *Indian Journal of Open Learning*. Vol. 11, No. 2. pp. 279–290. Retrieved on 01-03-2017 from: <http://journal.ignouonline.ac.in/iojp/index.php/IJOL/article/viewFile/539/412>
- Ritzhaupt, A.D., M. Stewart, P. Smith and A.E. Barron. 2010. An Investigation of Distance Education in North American Research Literature using Co-word Analysis. *The International Review of Research in Open and Distance Learning*. Vol. 11, No. 1. Retrieved on 17-03-2017 from: <http://www.irrodl.org/index.php/irrodl/article/view/763/1483>
- Zawacki-Richter, O., E.M. Baecker and S. Vogt. 2009. Review of Distance Education Research (2000 to 2008): Analysis of Research Areas, Methods, and Authorship Patterns. *International Review of Research in Open and Distance Learning*. Vol. 10, No. 6. Retrieved on 08-10-2020 from: <http://www.irrodl.org/index.php/irrodl/article/view/741/1461>

Prof. Savita Ladage
savital@hbcse.tifr.res.in
Hanza George, Project Scientific officer (B)
hanzageorge@gmail.com
Sugra Chunawala, Professor (H)
sugrac@hbcse.tifr.res.in

Reflections on the Cascade Model for Teacher Professional Development: A Case Study of RSC-Yusuf Hamied Inspirational Chemistry Programme in India

Abstract

The RSC-Yusuf Hamied Inspirational Chemistry Programme was launched in India in 2014 by the Royal Society of Chemistry (RSC, UK). A component of this programme was the professional development of about 8,000 chemistry teachers across India, in five years. This paper reports on an evaluation study conducted in 2018, that reflects on the implementation of the RSC teacher professional development (TPD) programme, via a cascade model. Our analysis of the RSC-TPD programme involved the use of multiple levels of evaluation proposed by Guskey. This study involves data collection from 32 government/ government-aided schools in three states of India. The findings present some evidence of the impact of the programme and highlight the need for sustained interactions with teachers.

Keywords: Teacher professional development, Cascade model, School chemistry education

Introduction

The RSC-Yusuf Hamied Inspirational Chemistry Programme was initiated in India by the Royal Society of Chemistry (RSC, UK) in 2014. This programme had a teacher development component referred to as the RSC-Yusuf Hamied Teacher Development Programme that was conceptualised for a period of five years (till 2018). It aimed to provide Teacher Professional Development (TPD) for around 8,000 chemistry teachers teaching in secondary schools across India. The TPD implemented by RSC was a cascade model that had three phases of transfer (Figure 1).

The three phases of transfer in this cascade model of RSC-TPD involved transfer of information from (i) primary

trainers to secondary trainers/teacher developers (TDs), (ii) TDs to teachers and (iii) teachers to students. As indicated in the figure, five primary trainers from the UK were experienced both in conducting TPD programmes and in the development of instructional materials. Forty-two TDs were trained as part of the programme with almost equal number of males (22) and females (20).

This paper discusses the implementation of the RSC-Yusuf Hamied Inspirational Chemistry Programme and attempts to capture the transfer of the training that occurred in RSC-TPD through different phases. The study is limited to a few government and government-aided schools in three states of India. These three states are located in different regions of India, namely, Karnataka (southwest), Kerala

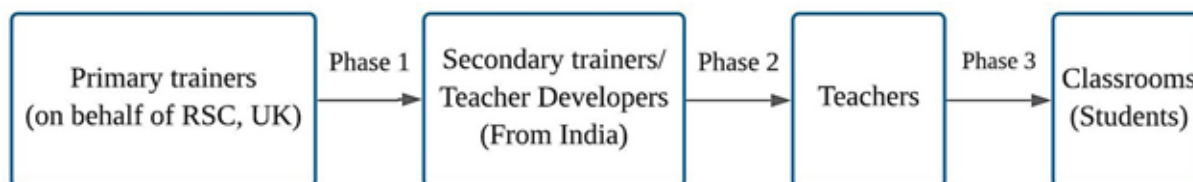

Figure 1. Teacher Professional Development (TPD) model for the RSC-Yusuf Hamied Inspirational Chemistry Programme

Table 1. Year-wise Details of the Number of Teacher Participants and Teacher Workshops Conducted in Karnataka, Kerala and Maharashtra²

State	Year	No. of teachers (2015)	No. of teachers (2016)	No. of teachers (2017)	Total number of teachers	Total number of workshops conducted till January 2018
Karnataka		1571	4052	3901	9524	447
Kerala		362	623	21	1006	76
Maharashtra		598	578	203	1379	91
Total		2531	5253	4125	11909	614

(south) and Maharashtra (west), though the TDs conducted RSC-TPD workshops in 24 states of the country. Table 1 presents some relevant data regarding the TPD workshops conducted by the TDs in the states mentioned above. Between January 2015 and January 2018, a total of 614 TPD workshops, were conducted for teachers from various schools in the states of Maharashtra, Karnataka and Kerala.

Table 1 indicates that the maximum numbers of workshops were conducted in Karnataka. Comparatively fewer workshops were conducted in Maharashtra and Kerala, respectively. Before we present data on the implementation of the TPD programme, we look at the merits and demerits of the cascade model, used for large scale TPD through some representative studies.

Use of the cascade model for TPD programmes

Introduction

The cascade model is widely used for large scale TPD as it can provide rapid diffusion of ideas in a short period (Suzuki, 2008; Karalis, 2016) and thus can be cost-effective (Thair & Treagust, 2003; Henly, 2005; Shezi, 2008). These reasons have often led to the use of the cascade model in developing countries (Lange, 2014). The cascade model is classified under standardized TPD models by Gaible and Burns (2005) who describe it as a model that follows a 'one size fits all' approach for the transfer of knowledge and skills. Kennedy (2005) has classified

TPD models into three main categories, namely, transmission, transitional and transformative, based on the purpose and the increasing capacity of professional autonomy that is provided to teachers.

According to her, a transmission TPD model is similar to the cascade model as it uses a top-down approach for transmission of information, where teachers are often passive participants.

She uses examples of mentoring and communities of practice to explain the transitional models of TPD. Mentoring uses one-to-one interactions between an experienced and a novice teacher, while communities of practice emphasise the role of peer group interactions. The transformative model is similar to action research and requires teachers to act as researchers. In contrast to the models under the transmission category, the transformative model considers the actions of teachers as reflections of their understanding, about classroom situations. Kennedy (2005) and Shezi (2008) further state that the cascade model is closer to a technician/'*teacher as technician*' view of training which emphasises skills and knowledge over attitudes and values. While discussing the key aspects that need to be considered for designing TPD using a cascade model, Hayes (2000) and Prince & Barrett (2014) suggest that gathering inputs from multiple stakeholders as well as harnessing their potential at various stages of the programme and in the development of instructional materials would result in a reflective and flexible approach

to teacher development as compared to the transmission mode of TPD.

The importance of backward planning for effective use of the cascade model has been highlighted by Guskey (2002) who argues that trainers must be aware of the objectives and desired outcomes of TPD at the preliminary stages itself as also organisational policies and favourable environments available to teachers at their workplace. The short duration of workshops, use of transmission mode by trainers, de-contextualization and adoption of the one-shot approach often reduces the effectiveness of cascade model TPD programmes (Aston, 1988; Shezi, 2008; Hunzicker, 2011; Gathumbi et al., 2013; Chigonga & Mutodi, 2019). An important variable for effective TPD, emphasized by various researchers, such as, Thair & Treagust (2003), Henly (2005), Lewin et al. (2009), Uysal, (2012); Prince & Barrett (2014) and Gameda & Tynjälä, (2015) is the provision of continual support to the teachers after they participate in the TPD workshop.

The debate about the use of the cascade model for TPD programmes summarised by Suzuki (2008) highlights two kinds of arguments. One argument asserts that there are inherent lacunae in the cascade model, which make this model unsuitable for TPD while the second argument claims that these lacunae are due to the improper implementation of the model and not due to its innate weaknesses. Consequently, for effective implementation, aspects such as defining the purpose of training, identifying the requirements of teachers, resources to be used, recruitment of trainers, the time allotted for each stakeholder to learn new concepts, the scaffolding of training at different levels and modification of the programmes based on the feedback obtained through regular monitoring are crucial parameters (Suzuki, 2008; Lange, 2013; Prince & Barrett, 2014; Karalis, 2016). The cascade model is based on an ideal scenario which assumes that the transfer of training will take place with almost equal efficiency across different layers of the model. However,

the distortion of information is most likely to happen if the TDs/secondary trainers do not internalise the keys ideas/concepts covered in the workshops or if they are unable to share the same with the teachers due to limited pedagogical experiences (McDevitt, 1998; Shezi, 2008). Thus, the selection of the secondary trainers will significantly affect the TPD programmes.

Some representative case studies of cascade models of TPD

Gaible & Burns (2005) have presented a case study of the use of the cascade model for a TPD programme involving teachers from 20 secondary schools in Tajikistan. In this study, longitudinal training of teachers, the arrangement of periodical cluster meetings and collaborative projects were some of the significant factors that led to the successful implementation of the programme. Also, in this programme, the teacher trainers' remunerations, were directly linked to two factors: (i) performances of the teachers trained by them and (ii) students' learning. Gaible and Burns also highlighted that the facilities available during the training of a limited number of individuals as expert trainers are different from those that are available at the local level, and this can affect the TPD workshops at local levels. Further, the lack of facilities at the classroom level is likely to affect the implementation of new strategies in the classrooms. Thus, awareness about the facilities at grass-root levels is crucial while designing TPD programmes, especially in developing the instructional materials to be used for the training.

A study of the effectiveness of the cascade model for training of in-service teachers in Nepal, using a four-layered cascade model was conducted by Suzuki (2008). This model led to the professional development of an impressive number of primary teachers. The programme was also cost-effective as it could train more than 90 thousand teachers in six months. However, she highlighted the inadequate transfer of concepts to the teachers through the programme. In her

opinion, the trainers at the topmost layers were highly qualified content experts but lacked teaching experiences for primary schools. The trainers at the lower levels had adequate teaching experiences but could not present enriched discussions about the content. In her opinion, identifying such gaps and working towards bridging them is crucial for the successful implementation of the cascade model for TPD programmes.

A qualitative study involving around a hundred Adult Basic Education and Training (ABET) teachers from the north-west province of South Africa was presented by Mokhele & Dichaba (2012). Their study focused on five key areas: content knowledge of trainers, content delivery, the efficiency of transmission of information, confidence of teachers in cascading the information obtained from the training and finally the implementation of the new strategies in classrooms. They found that the teacher participants reported that their trainers were skilled and knowledgeable but believed that crucial information was distorted and even lost through the layers of the cascade programme. Only 29 per cent of the participants strongly agreed that they were confident about cascading information to their colleagues and more than 50 per cent of teachers were not comfortable using the key ideas from the training in their classrooms. Overall, the researchers did not consider the cascade model to be successful at the classroom implementation level.

In 2012, Teacher Educators from a UK University and representatives from the Republic of Kazakhstan while introducing new pedagogical approaches to Kazakhstani teachers, using a three-layered cascade model, incorporated an important component, that is, mentoring of secondary trainers, by the primary trainers, to deal with the dilution effect. The mentors (primary trainers) were expected to analyse their mentees performance, generate reports and provide appropriate feedback. Turner et al. (2017) evaluated this programme, based on the five points listed by Hayes

(2000) and in their opinion, the key factor responsible for adequate transfer of content knowledge throughout the different layers was mentoring.

In the Indian context, Ngeze et al. (2018) evaluated the effectiveness of the cascade model used for TPD of around a hundred and fifty in-service instructors belonging to six technical institutions, during a four-week long, three-layered cascade teacher development programme. They collected data from the primary and secondary trainers through interviews and the study recommended that the primary trainers should attend a few of the sessions conducted by the secondary trainers which could be followed by a feedback meeting. Another recommendation of the study was that opportunities must be provided to secondary trainers to share their experiences as these could create a support system for them, during the implementation of the training.

The cascade model thus appears to be an unavoidable option when a large number of teachers need to be trained. As indicated in the above section, appropriate planning, careful selection of individuals at the first level of training and the inclusion of teacher representatives in the planning stage to increase awareness about classroom realities are some of the crucial factors for the implementation of this model. Any evaluation study for TPD programmes conducted using a cascade model needs to look at aspects such as challenges faced by various stakeholders, distortion of key ideas across phases of transfer, the factors responsible for the same and the impact of the training at the grass-root level. Based on the representative studies from literature, we tried to focus on these aspects while evaluating the teacher development component of *RSC- Yusuf Hamied Inspirational Chemistry Programme* in India.

Theoretical framework

Thomas R. Guskey has developed a framework which is widely adopted for



evaluation of TPD programmes (Guskey, 2002). According to this framework, while evaluating TPD programmes, it is essential to gather and examine the information at five levels: (i) participants' reactions (ii) participants' learning (iii) organisation support and change (iv) participants' use of new knowledge and skills and (v) student learning outcomes.

While evaluating *RSC-Yusuf Hamied Inspirational Chemistry Programme* in India, we applied three levels of Guskey's evaluation framework for both the transfer stages of the programme, that is, training of TDs by primary trainers and training of teachers by TDs. To understand the effectiveness of the programme at Level 1 (that is participants' reactions level), we gathered the feedback *post facto* from TDs and teachers using survey questionnaires and a few personal interviews.

The participants' learning level, is about measuring the skills or knowledge gained by participants. The RSC-TPD programme had focused on developing activities/strategies for active learning in the classrooms. Thus, we tried to gather evidence for whether (i) the TDs/teachers prepared activity-based resources for topics other than those covered in the workshops (ii) any modifications were incorporated, by the participants to the original worksheets/activity templates and (iii) any new resources/activities were designed by participants during and after the RSC-TPD workshops. We could not collect data or evidence for Level 3 of Guskey's framework regarding the organisational support and change. However, the school visits and teachers' interviews presented some glimpses about the sociocultural factors in teachers' work environment. Additionally, the teachers' questionnaire had some questions related to the infrastructure of the schools.

Regarding the level 4, participants' use of new knowledge and skills, we observed the RSC-TPD workshops conducted by the TDs and the teaching-learning processes in

participant teachers' classrooms *post facto*. We tried to gather evidence for whether the illustrated activities and/or new activities were being used effectively by the teachers in the classrooms. The focus group discussions with students provided more clarity regarding the Active Learning Strategies (ALS) in use.

When we started the evaluation, the TDs had already conducted a significant number of TPD workshops in different states. The schools sampled for data collection were located geographically far apart and were also distant from our location. Thus, we could not visit the schools frequently for classroom observations. Even though some teachers mentioned aspects like students' improvement in learning and enhancement in students' confidence levels, we could not gather much evidence to ascertain the actual impact of the RSC-TPD programme on the students' learning outcomes within the short-stipulated duration of time available for the evaluation study. Thus, for our evaluation study, we focused on levels 1, 2 and 4 of Guskey's framework. Table 2 presents the details of the tools and representative questions used for data collection at different levels of Guskey's framework for TDs and teachers.

Table 2: Data Collection from TDs and Teachers for Different Levels of the Model Provided by Guskey

Levels	Data collection	Representative questions for TDs	Representative Questions for teachers
Level 1: Participants' Reactions	Survey/ Questionnaires, workshop observations and interviews	In your opinion, what was different about RSC training? (Aspects you liked/did not like).	What is your opinion about activities learnt at RSC- TPD workshop?

Level 2: Participants' Learning	Survey/Questionnaires, workshop observations and interviews	In what way RSC training has equipped you as a teacher developer? Apart from the units provided by RSC, for TPD workshop, have you developed and used any other activities?	Have you prepared new resources? Have you prepared such activities for subjects other than chemistry?
Level 4: Participants' Use of New Knowledge and Skills	Survey/Questionnaires, workshop observations, classroom observations and interviews	How do you deal with large group of teachers during workshop? How did you handle problems related to content?	Do you use the activities learnt at RSC teacher training workshop? If yes, how frequently?

RSC-Yusuf Hamied Inspirational Chemistry Programme in India: Teacher Development Component: A Case study

Introduction to the programme

In this section, we will discuss the salient features of the TPD programme, conducted

as part of *RSC-Yusuf Hamied Inspirational Chemistry Programme* in India. Figure 2 indicates the progression of the programme since its pre-launch stage to its evaluation. Before the formal launch of the programme in 2014, the primary trainers from the UK, who were a team of members responsible for content development and training of teacher developers, visited a few schools in India. Additionally, they held workshops with in-service chemistry teachers in 2013, to get first-hand experiences about school chemistry education, in the Indian context.

The main purpose of the school visits and workshops in the pre-launch phase was to acquaint the primary trainers with the Indian school system and to gather baseline information, that would be important for the planning and development of instructional materials for use in the teacher development programme. The instructional modules for the RSC-TPD included topics from the chemistry textbooks produced by National Council of Education, Research and Training, (NCERT) India. The three modules were: (i) towards active learning (ii) chemical reactions and equations and (iii) the particle nature of matter. The focus of the first instructional module was on developing ALS to engage learners. These strategies were adaptable for teaching-learning of any subject/topic. Another key area covered by the instructional module was based on experimental activities that are low-cost, require readily available materials and are micro-scale. The module on the particle nature of matter focused on misconceptions in chemistry, which is an important dimension for teaching-learning of

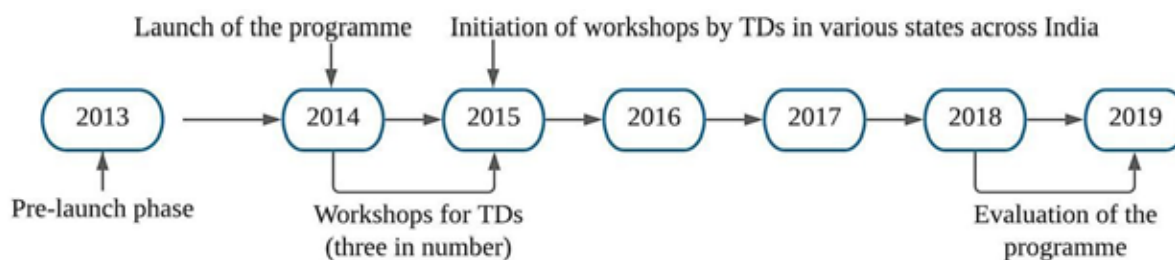

Figure 2. Timeline for the TPD Programme by RSCt

chemistry, at the secondary school level. The topic of chemical reactions and equations is central to the secondary school chemistry syllabus. Thus, the instructional modules developed for the programme addressed the core domains of school chemistry. While designing each module, separate booklets were developed for different layers of the cascade model, namely (a) the primary trainers: experts responsible for the training of teacher developers (b) teacher developers: group of individuals selected for training (TDs) and (c) teachers: participants of the teacher development workshops conducted by TDs.

These booklets differed significantly in terms of complexities and approaches adapted for discussions of the contents, for example, the booklets for teachers tended to be more concrete, simple to understand and contained exemplar worksheets and activity cards for various chemistry topics, which could be used in classrooms directly. Besides, blank templates were available to design similar activities for more chapters. The experimental activities could be performed by teachers as demonstrations or were doable by students. The booklets also included information about useful websites, computer-based simulations and e-resource portals (including RSC website) for the teaching of chemistry at the secondary level. The booklets for TDs incorporated additional discussions about chemistry concepts, experiments and guidelines for using various chemistry softwares useful to generate resources including ICT based resources useful for teacher development workshops. The primary trainers' booklet discussed aspects such as exploring pedagogies in chemistry, development of active learning resources, self/peer-assessment and misconceptions, in addition to the content discussion. Each booklet contained explicitly stated learning objectives and expected learning outcomes. Thus, overall, the instructional booklets covered more reflective and pedagogical aspects for primary trainers and TDs as compared to

that for teachers. Overall, these booklets are good examples of designing instructional materials suitable for the different levels of cascade model TPD programmes.

Selection of a group of Teacher Developers

A critical parameter for the cascade model of TPD is the selection of individuals who act as secondary trainers. The selected group of 42 TDs were from diverse backgrounds and differed substantially in terms of age, years of service, regional language and previous experience with teacher education. Most of the TDs were from Karnataka, Kerala or Maharashtra and were conversant with at least two Indian languages, apart from English and were associated with the teaching of chemistry at the school level. The recruitment of a diverse group of TDs can be advantageous as it can lead to rich peer-interactions and/or primary trainers-TDs interactions during capacity building workshops for TDs.

Workshops for TDs

Three workshops, each of five-day duration, were conducted by the primary trainers for the TDs, during 2014–2015. The first development workshop primarily focused on module 1, that is, the ALS along with group work, reflective thinking and introductory sessions about misconceptions in chemistry. After the first workshop, TDs were encouraged to conduct some pilot workshop/s in their local areas so that they could share their experiences and the challenges faced by them in the subsequent workshop.

During the second workshop, the primary trainers provided the TDs sufficient time for sharing their experiences from the pilot workshops conducted by them. This workshop covered activities and experiments that can be used while teaching various chemical reactions and equations in secondary level chemistry classes. Moreover, TDs were encouraged to develop resources that could be used by them in the workshops they would conduct. The third

workshop, conducted after a gap of a year, focused on content enrichment about some of the core topics in chemistry syllabi at the secondary/higher secondary levels. Also, the focus on generating resources using ICT continued. This workshop included more detailed discussions about misconceptions in chemistry as requested by the TDs. Thus, across these three training workshops, progressively, the TDs were empowered to conduct TPD workshops and reduce their dependence on the primary trainers.

Results

Impressions through interactions with TDs

As part of the evaluation study, we interacted with TDs to understand their impressions about the programme. Through a questionnaire and personal interviews with TDs, we gathered information regarding their capacity building, the number of workshops conducted by them, resources developed, challenges faced and the strategies adopted by them to overcome challenges, etc. Additionally, we observed TPD workshops by seven TDs to understand how they conducted the workshops and what was being transferred in the process to teachers.

Overall, we found that the TDs were highly positive about their capacity building. In our survey, we obtained responses from 20 TDs who were actively conducting TPD workshops and the consensus opinion among these TDs was that the RSC training not only equipped and empowered them for conducting the RSC-TPD workshops but also helped them to mature as facilitators. While evaluating the programme in 2018, we observed that only half the initial number of the TDs were actively conducting TPD workshops. The TDs who could not conduct the workshops were primarily in-service teachers. Informal interactions with a few of these in-service teachers (TDs) indicated that their inability to get leave from their schools/institutions was the primary reason for non-conduct of TPD workshops. This situation also reduced

opportunities for them to visit other schools in order to organise workshops.

We observed seven RSC-TPD workshops conducted by different TDs in the states of Karnataka, Kerala, Maharashtra, Gujarat and Madhya Pradesh. The duration of each workshop was generally two days. The number of teacher participants ranged from thirty to forty. The discussions during the workshops revolved around the RSC booklets for teachers and often the sessions were successful in actively engaging the participants. During these workshops, we observed that the TDs had extended the inventory of resources to other subjects and local languages. The workshops were highly interactive and significant efforts were made by TDs to exemplify the idea of active learning to teachers. Often, the TDs communicated both in English and the local languages.

We also observed that teachers from other disciplines (biology, physics, mathematics etc.) often participated in the workshops originally designed for chemistry teachers. In such cases, experiments from physics and biology, in addition to chemistry, using low cost, easily available materials were demonstrated and discussed by TDs. For a few workshops, the teacher participants also performed the experimental activities on their own. The RSC chemistry experiments were modified by TDs using the materials available at the local level; making these more accessible to teacher participants. Some TDs also ensured that towards the end of the workshops, the teacher participants collaboratively designed lesson plans for any topic from their discipline, using various ALS. All these efforts by TDs demonstrate that they had not only internalized the key ideas introduced to them but were also able to customise them as per the needs at the local levels.

The TDs faced several challenges in organizing the workshops. The list of common challenges faced by TDs is presented in Table 3 along with how TDs dealt with these challenges. One of the main hurdles faced in the initial phase of the programme was to



gain permissions from schools to conduct the workshops. Often, TDs managed to obtain the permissions through personal contacts or by collaborating with NGOs or other Government bodies. When TDs had to curtail the duration of the workshops due to various constraints, the session on misconceptions tended to be compromised. The module on student misconceptions, due to its abstract nature, was generally conducted after the introduction of the ALS and the module on chemical reactions (including experimental activities). As mentioned before sensitization of teachers to student misconceptions, especially about the particulate model of matter, a central explanatory framework in chemistry, is crucial in the adoption of teaching strategies in the chemistry classrooms. However, in some cases, TDs did not have much control over the time allocated to them for the conduct of TPD workshops and thus even though they were keen on conducting the misconception sessions; they were unable to do so.

The teacher participants were positive during the feedback sessions at these workshops and appreciated (i) the active engagements (ii) the concrete activities done by TDs and given in the booklets which according to them would be useful in classrooms and (iii) the conduct of the sessions. Overall, teachers mentioned that these workshops helped to understand the philosophy of ALS.

Impressions through interactions with teachers and classroom observations

To understand the percolation of ideas to the chemistry classrooms, we visited several schools and observed classes. Our sample comprised of 32 Government/Government aided schools, located in urban, semi-urban and rural areas of Maharashtra, Karnataka and Kerala. We kept in mind the time gap between the RSC-TPD workshops and our visits, and this gap varied from a few months to 2 years.

Table 3: Challenges Faced by TDs and the Strategies Adopted by them to Overcome these Challenges³

Challenges faced by TDs	Strategies adopted by the TDs
Organising workshops	Using personal contacts/Public-Private partnerships
Non-availability of proper infrastructure and materials	Carrying essential chemicals, laptops, projectors, UPS and other requirements with them. Substituting glass-wares and apparatus with easily available low-cost materials.
Dealing with a large group of teachers (more than 100)	Increasing the number of TDs per workshop and dividing the teachers into smaller groups.
Teachers who speak regional languages	Using a combination of both English and the regional language whenever possible. Requesting participant teachers to translate some of the technical terms Including games and activity cards in regional languages.
Dealing with a mixed group of teachers (Physics, Biology, Mathematics etc.)	Including a few games and activities related to non-chemistry subjects.

The data collection, from the selected schools, commenced in July 2018 and lasted until January 2019. The states mentioned above exhibited considerable linguistic diversity reflected in the media of instruction, especially at the school level. Regional language and semi-English (that is only science/mathematics taught in English) schools are common in these states in addition to the English language schools. For these three states, we selected a few schools from 3 to 4 districts. Owing to the torrential rainfall and resultant deluge in 2018, we confined the data collection in Kerala to five schools.

In this paper, we are presenting our observations for schools in the states of Karnataka (10 schools), Maharashtra (17 schools) and Kerala (5 schools) where the medium of instruction was either regional language or semi-English. Apart from classroom observations, we conducted semi-structured interviews with teachers and held focus group discussions with students in schools where activities from RSC modules were being implemented in the classrooms. The purpose of the focus group discussion was to understand the acquaintance of students with the activities as an indirect measure of implementation of ALS in the classrooms.

Due to time constraints and geographical locations of the schools, we visited these schools only once post the teacher development workshops. More frequent visits to these schools would have been useful in gaining in-depth insights about the classroom scenarios. This is a limitation of the study.

For Karnataka schools, the gap between our visit and the RSC-TPD workshops was at least one year or sometimes two years. Despite the considerable gap, teachers from schools in Karnataka were able to remember their TPD workshops and were highly positive about them. They were appreciative about both the content and pedagogical expertise of the TDs and the RSC modules. These impressions reinforce the proactive

roles played by TDs for the TPD programme.

In most of our sample schools in Karnataka, teachers were using ALS and other activities from RSC modules in science classrooms. We witnessed the development of resources in both English and regional languages, by teachers for different science topics and their usage in classrooms. However, the teachers used these resources primarily as revision tools or evaluation tools rather than for teaching of new concepts. The activities were implemented as group activities and were engaging for students. In the case of the experimental activities, the demonstration mode was the predominant method used by teachers. During interviews, teachers expressed concerns regarding the safe handling of chemicals by students and stated that monitoring all students in the classrooms (or in laboratory space) is not easy. Thus, teachers perceived the demonstration model to be the 'safe' mode for chemistry experimental activities. The micro-scale model of experimentation was also not considered to be suitable for classroom demonstration purposes by the teachers hence they refrained from using it.

An intriguing development that we noticed in Hejamadi, (from Udupi district on the west coast of Karnataka), was that a group of teachers formed a practice of exchanging the resources developed by them. This collaboration played a vital role in the generation of resources and their continual use. These teachers opined that continual interactions and discussions with the TDs helped them be more confident in integrating the ALS based approach with their classroom teaching practices. During focus group discussions, we observed that most of the students were familiar with the ALS, indicating that these activities were being used in the classrooms fairly regularly. In most of these schools, the number of students in the classrooms was about 40 (or less) and thus the class could be managed by a single teacher using group work. Besides, the teachers had autonomy to execute ALS and other activities in the classroom.



Overall, for the schools visited by us in Karnataka, the presence of motivated teachers, the optimal number of students in the classroom and the positive attitude of the school authorities acted as a catalyst in integrating ALS with the classroom teaching-learning process. However, it is possible that if the cascade model would have included opportunities for sustained interactions between TDs and teachers, the impact of the RSC-TPD programme on the classroom practices would have been better since other favourable conditions were existing.

In Maharashtra, we also collected the post-development workshop data from 17 schools. For these schools, the gap between the RSC-TPD workshops and our data collection varied from two years to a few months. Besides, we also collected baseline data from 9 schools before the occurrence of teacher development workshops. We observed classes of a few teacher participants from Jalgaon district (a district in the northern part of Maharashtra) who had participated in RSC-TPD workshop. These teachers were using the ALS and these schools were more diverse in terms of the students' population and infrastructure as compared to the schools we observed in Karnataka. The number of students per classroom was about 50 to 60 per teacher, in the schools in Maharashtra and with such a student-to-instructor ratio, adapting and using ALS was not easy for teachers.

Of the 5 schools in Jalgaon district, one was a well-established school; the second was a rural school with fairly good infrastructure and facilities, whereas the remaining 3 were residential schools catering to tribal populations and located in tribal-dominated areas. In one of the tribal schools, we observed a few activities being used even at the primary school for teaching environmental studies. This was evidence that the ALS and other activities in RSC modules were adaptable even at primary level. This example also indicated that highly motivated teachers were successful in efficiently adapting the key ideas introduced

through the RSC-TPD workshop for their classes. However, the situation in chemistry classrooms at the secondary level was not as rosy. We observed that even though the activities were being used in secondary classrooms, teachers often did not play the role of facilitators effectively. We saw that often opportunities for appropriate questioning were missed by the teachers and thus, students did not gain much from the activities. At times the activities were performed in a perfunctory manner.

In personal interviews, some of the teachers from the tribal schools stated that they could not internalize the key ideas of the RSC-TPD workshop due to a language barrier. They felt that more TPD workshops and particularly activities/resources in regional languages would have

helped them, to adapt and use these activities in their classrooms. Another fact that emerged through the discussions was that the schools shifted the medium of instruction for science and mathematics from regional to the English language. Thus, teaching-learning in 'English' was a huge challenge, both for the teachers and students and was the central concern for these schools. In such a scenario, innovating with the conventional teaching-learning practices took a back seat. This exemplifies what other researchers such as Thair & Treagust (2003), Wedell (2005), Avalos (2011), Shezi (2008), Gathumbi et al. (2013), Prince & Barrett (2014) and Gameda & Tynjälä (2015) have indicated with respect to the need for individuals at the topmost layers of the cascade to be cognisant of the sociocultural factors in the teachers' work environment as these could impede the implementation of new strategies in classrooms.

Moreover, since the RSC-TPD workshops were being planned for some of the areas of Maharashtra, we collected baseline data from 5 schools of Ratnagiri (a coastal district in the western part of Maharashtra) and 4 schools of Bhor (a town in Pune district towards the western part of Maharashtra).

In these schools, teachers primarily used chalk and talk or the lecture method, in the chemistry classrooms that we observed. In a few of these schools, teachers demonstrated simple experiments while teaching some of the chemistry concepts.

On our visit to these schools, post RSC-TPD workshops (with a gap of 1 to 2 months); we did not witness any significant changes in the chemistry classrooms. Teachers were not implementing ALS and other activities in the classrooms, so we tried to understand the reasons for the same. In the Bhor region, where the class size often ranged between 60-80 students per division, teachers expressed their inability to handle group work. One of the teachers who did make efforts to implement the activities expressed a dilemma about the ideal group size for the activities. He wanted to be able to monitor each group and thus made groups with 10-12 students per group. However, such a large number of members in a group led to the fragmentation of the group into smaller groups and then class control became an issue. Despite this situation, the teacher did not want to make groups with few members (3 to 4 students/group) as monitoring the class would have been a challenging task. Thus, the teacher decided not to use ALS as he did not know how to resolve this problem of group size. Also, the generation of an adequate number of resources for large class sizes demands time; which teachers were unable to allocate with their existing workload in the schools. These are representative examples of how certain factors in the teachers' work environment can hamper the implementation of key ideas covered in TPD. The problems raised by teachers are genuine and need solutions if ALS have to be integrated into classroom teaching. Without sustained interactions between TDs and teachers and no rectifying measures to enhance the student-to-instructor ratio, it was difficult for the TDs to fathom the intensity, at which various factors in the classrooms of the participating teachers were likely to affect

the implementation of the programme. For TDs to understand the various vital factors relevant for the participating teachers and schools, there is a need for them to visit at least a few representative schools, especially before conducting the RSC-TPD workshops and also after.

In Ratnagiri region, apart from time constraints and the perceived infeasibility of ALS for large classrooms, teachers mentioned the vastness of syllabus, content overload and the conventional mode of assessment as additional factors that hampered the implementation of ALS and other activities. Teachers also opined that such strategies are more suitable for teaching science at lower classes rather than at the secondary level. Overall teachers need support if they are to make a shift from conventional teaching to activity-based learning.

As compared to Karnataka and Maharashtra, the sample from Kerala was limited. During the period of evaluation, Kerala was hit by torrential rains and recurrent flooding due to which the school schedules were affected substantially. We were able to visit five schools, located in three districts of Kerala, that is Idukki (a district in the central part of Kerala), Calicut and Malappuram (districts in the northern parts of Kerala). However, the school scenario in this state was significantly different from Karnataka & Maharashtra.

During our visits, we observed the government school classrooms in Kerala, equipped with laptops and projection facilities. In 2017, the Kerala government initiated the *Pothu Vidyabyasa Samrakshana Yajnam* (Mission to Protect Public Education) to improve the quality of education in public schools. As a result, numerous government and government-aided schools had substantial development of infrastructure including laptops and projectors facilities (Varma, 2018).

In addition to this, an e-resource portal called *Samagra* was also launched for school education by the state government.

Through interaction with teachers, we learned that the portal provides them with e-resources and lesson plans that are linked directly to their syllabus. Most importantly, these resources are in regional languages. Teachers frequently used these resources and were satisfied with them, primarily because of the direct connect to the syllabus. Additionally, the content could be edited as per need by the teachers who were also responsible for maintaining records of the usage of e-resources.

The teacher participants from the sample schools in Kerala had attended the RSC-TPD workshops during the year 2015–2016. Even with such a large time gap, we observed that a few ALS activities introduced by the RSC-TPD were being used in classrooms. Similar to teachers from Maharashtra, some of the teachers from Kerala, in the interviews, mentioned the vastness of the syllabus, classroom management and time constraints as the primary factors for non-implementation of activities. In our sample schools from Kerala, the number of students in the classrooms on an average was around 40. This class size is comparable to that in schools of Karnataka where teachers used ALS more frequently. Nevertheless, a few teachers in Kerala mentioned the number of students in the classrooms as one of the factors for non-implementation of ALS.

A crucial factor that affected the implementation of ALS and other activities in Kerala schools was the availability of e-resources through *Samagra*. The ALS and other activities introduced by RSC-TPD were not ICT based and were not linked to school chemistry syllabus directly. Teachers in Kerala had shifted to using technology in classroom teaching and were primarily interested in ICT based resources. With easy access e-resources in regional languages, adapting them for classrooms was a convenient option for teachers. Teachers also mentioned peer group interactions through routine cluster meetings as a valuable support system.

Thus, the evaluation study for the RSC-TPD programme indicates the following: (i) the programme was successful at level 1 of Guskey's model for both TDs and teachers as they were highly appreciative about their development (ii) we witnessed strong evidence, both for TDs and teachers regarding the development of new resources and appropriate adaption of the illustrated resources, indicating the transfer of the key ideas (iii) however, for level 4, the usage of illustrated/new resources and the pedagogical skills by teachers varied substantially across the states and was primarily influenced by the classroom realities, especially, by the number of students in the class (iv) the programme was affected at level 4 due to absence of sustained support to teachers in terms of follow-up/feedback mechanism and (v) awareness about the sociocultural factors at the school level is important for planning and implementation of TPD programmes.

Discussion

For the cascade model implemented by RSC-TPD in India, there was evidence that the capacity- building workshops and the instructional resources helped TDs to develop as facilitators and also build their confidence to conduct workshops independently. Teachers were found to be highly appreciative of the content knowledge of TDs and the manner in which the TPD workshops were conducted. We found the implementation of the ALS by the teachers in chemistry classrooms to be better in Karnataka where maximum workshops had been conducted as compared to other states.

However, we observed that even in Karnataka, the ALS did not take a central position in chemistry (science) classrooms. A critical factor that appeared to hamper the transition of ideas to the classrooms was the lack of a sustained support system for the teachers. The post-workshop interactions between the teachers and Teacher Educators are important as these can help teachers receive appropriate feedback while

planning and implementing new techniques. According to Turner et al. (2017), the mentoring of teachers is vital for the success of the cascade model of TPD programmes. Providing opportunities for the active involvement of teachers in their professional development through action research and peer interactions in the form of collaboration, co-learning, cluster meetings, mentoring of novice teachers by senior teachers etc. are also effective approaches that can enhance positive changes in the classroom teaching-learning process (Guskey, 2002; Thair & Treagust, 2003; Henly, 2005; Shezi, 2008; Lewin et al., 2009; Mokhele & Jita, 2010; Avalos, 2011; Hunzicker, 2011; Ramnarain & Ramaila, 2012; Gathumbi et al., 2013; Bett, 2016).

The RSC-TPD focused primarily on the transfer and propagation of ideas to a pre-set target population of teachers. However, there was no emphasis on post-workshop interactions with teachers. During the initial stages of the programme, the TDs bore the sole responsibility of seeking permission for arranging and conducting RSC-TPD workshops. With limited access to school systems, it was difficult for TDs to learn about the socio-cultural factors and the challenges faced by teachers in the classrooms. Such an understanding would be useful for secondary trainers (TDs in this case) to arrive at plausible solutions.

Some of the positive aspects of the RSC-TPD programme regarding its implementation by the cascade model were: (i) efforts for mapping of instructional material on the National level chemistry syllabus (NCERT) in the Indian context (ii) identification of some of the key areas/concepts in Indian chemistry school syllabus/textbooks (iii) development of instructional modules for different stakeholders (primary trainers, TDs and teachers) and (iv) structure and progression in the development workshops conducted for TDs.

Conclusion

The knowledge gained from the evaluation of TPD programmes can strengthen various aspects of the same or similar programmes, such as its design, content, delivery/execution, organizational support and feedback systems (Guskey 2002). In our opinion, measures like producing resources in regional (Indian) languages, initiating periodic follow-up with at least some teachers, mentoring teachers through on-line mode are important in making TPD programmes effective in terms of their impact on the conventional teaching-learning practices in schools. Another possible measure suggested by Gaible and Burns (2005) and Wedell (2005) is the collaborations between teachers from different schools in the same geographical area through structured meetings. Such interactions can act as a catalyst for the actual implementation of teaching strategies. Such meetings did take place in the state of Kerala and teachers acknowledged their significance in arriving at solutions for the teaching (and other) challenges in the classrooms. Initially, TDs can take a central role as facilitators in these meetings, and this role over a period can be shifted to competent teachers to empower them, a process similar to the one that took place in capacity building of TDs by primary trainers.

We hope that the observations from this study would help in better planning and implementation of TPD programmes based on the cascade model. Awareness about diverse scenarios in the classrooms among the experts as well as secondary trainers is important in the implementation of large scale TPD programmes. Furthermore, a sustained support system for teachers through interactions with secondary trainers needs to be an integral part of the cascade model for better percolation of ideas to the classroom.



References

- ASTON, M. 1988. Professional Development and Teacher Education: Have We Got it Right? *Computers & Education*. Vol. 12, No. 1. pp. 79–83. [https://doi.org/10.1016/0360-1315\(88\)90059-0](https://doi.org/10.1016/0360-1315(88)90059-0)
- AVALOS, B. 2011. Teacher Professional Development in Teaching and Teacher Education over Ten Years. *Teaching and Teacher Education*. Vol. 27, No. 1. pp. 10–20. <https://doi.org/10.1016/j.tate.2010.08.007>
- BETT, H.K. 2016. The Cascade Model of Teachers' Continuing Professional Development in Kenya: A Time for Change? *Cogent Education*. Vol. 3, No. 1. pp. 1–9. <https://doi.org/10.1080/2331186x.2016.1139439>
- CHIGONGA, B. AND P. MUTODI. 2019. The Cascade Model of Mathematics Teachers' Professional Development in South Africa: How Well did it Suit Them? *EURASIA Journal of Mathematics, Science and Technology Education*. Vol. 15, No. 10. pp. 1–9. <https://doi.org/10.29333/ejmste/109261>
- GAIBLE, E. AND M. BURNS. 2005. *Using Technology to Train Teachers: Appropriate Uses of ICT for Teacher Professional Development in Developing Countries*. Washington, DC: infoDev / World Bank. Available at: <http://www.infodev.org/en/Publication.13.html>
- GATHUMBI, A.W., N.J. MUNGAI AND D. HINTZE. 2013. Towards Comprehensive Professional Development of Teachers: The Case of Kenya. *International Journal of Process Education*. Vol. 5, No. 1. pp. 3–14.
- GEMEDA, F.T. AND P. TYNJÄLÄ. 2015. Professional Learning of Teachers in Ethiopia: Challenges and Implications for Reform. *Australian Journal of Teacher Education*. Vol. 40, No. 5. pp. 1–26. <http://dx.doi.org/10.14221/ajte.2015v40n5.1>
- GUSKEY, T.R. 2002. Does it Make a Difference? Evaluating Professional Development. *Educational Leadership*. Vol. 59, No. 6. pp. 45–51.
- HAYES, D. 2000. Cascade Training and Teachers' Professional Development. *ELT Journal*. Vol. 54, No. 2. pp. 135–145. <https://doi.org/10.1093/elt/54.2.135>
- HENLY, J. 2005. The Primary Education Improvement Project of Vanuatu: A Model for Teacher Development in the Pacific. *Journal of Educational Studies*. Vol. 27, No. 2. pp. 25–36.
- HUNZICKER, J. 2011. Effective Professional Development for Teachers: A Checklist. *Professional Development in Education*. Vol. 37, No. 2. pp. 177–179. <https://doi.org/10.1080/19415257.2010.523955>
- KARALIS, T. 2016. Cascade Approach to Training: Theoretical Issues and Practical Applications in Non-Formal Education. *Journal of Education & Social Policy*. Vol. 3, No. 2. pp. 104–108.
- KENNEDY, A. 2005. Models of Continuing Professional Development: A Framework for Analysis. *Journal of In-service Education*. Vol. 31, No. 2. pp. 235–250. <https://doi.org/10.1080/13674580500200277>
- LANGE, S. 2014. Learner Orientation through Professional Development of Teachers? Empirical Results from Cascade Training in Anglophone Cameroon. *Compare: A Journal of Comparative and International Education*. Vol. 44, No. 4. pp. 587–612. <https://doi.org/10.1080/03057925.2013.841027>
- LEWIN, C., P. SCRIMSHAW, B. SOMEKH AND M. HALDANE. 2009. The Impact of Formal and Informal Professional Development Opportunities on Primary Teachers' Adoption of Interactive Whiteboards. *Technology, Pedagogy and Education*. Vol. 18, No. 2. pp. 173–185. <https://doi.org/10.1080/14759390902992592>
- MCDEVITT, D. 1998. How Effective is the Cascade as a Method for Disseminating Ideas? A Case Study in Botswana. *International Journal of Educational Development*. 18, pp. 425–428.
- MOKHELE, M.L. AND M.M. DICHAHA. 2012. Does the Cascade Model Work for Teacher Training? Analysis of Teachers' Experiences. *International Journal of Educational Sciences*. Vol. 4, No. 3. pp. 249–254.

- MOKHELE, M.L. AND L.C. JITA. 2010. South African Teachers' Perspectives on Continuing Professional Development: A Case Study of the Mpumalanga Secondary Science Initiative. *Procedia - Social and Behavioral Sciences*. 9. pp.1762–1766.
- PRINCE, E.S. AND A. BARRETT. 2014. Continuing Professional Development in Action: An Indian Experience, Innovations in the Continuing Professional Development of English Language Teachers edited by David Hayes, British Council, UK, ISBN 978-0-86355-741-5. pp.19–42. https://www.britishcouncil.in/sites/default/files/e168_innovations_in_cpd_final_web.pdf
- RAMNARAIN, U. AND S. RAMAILA. 2012. Mentoring as a Viable and Sustainable Form of Professional Development for Physical Science Teachers. *Education as Change*. Vol. 16, No. 2. pp. 255–268. <https://doi.org/10.1080/16823206.2012.745754>
- Reference removed for double-blind review
- SHEZI, V.S. 2008. Does the Cascade Model Work for Teachers: An Exploration of Teachers' Experiences on Training and Development Through the Cascade Model. https://pdfs.semanticscholar.org/d3b6/c1be3f3f0bd59328ae15c90e73b0585a3204.pdf?_ga=2.111018886.20829055.1590738456-468197888.1586356198, accessed May 28, 2020.
- SUZUKI, T. 2008. The Effectiveness of the Cascade Model for In-service Teacher Training in Nepal. *IMSCI 2008 - 2nd International Multi-Conference on Society, Cybernetics and Information*. (Proceedings 1. pp. 272–277).
- THAIR, M. AND D.F. TREAGUST. 2003. A Brief History of a Science Teacher Professional Development Initiative in Indonesia and the Implications for Centralised Teacher Development. *International Journal of Educational Development*. Vol. 23, No. 2. pp. 201–213. [https://doi.org/10.1016/s0738-0593\(02\)00014-7](https://doi.org/10.1016/s0738-0593(02)00014-7)
- TURNER, F., S. BROWNHILL AND E. WILSON. 2017. The Transfer of Content Knowledge in a Cascade Model of Professional Development. *Teacher Development*. Vol. 21, No. 2. pp. 175–191. <https://doi.org/10.1080/13664530.2016.1205508>
- UYSAL, H.H. 2012. Evaluation of an In-service Training Program for Primary-school Language Teachers in Turkey. *Australian Journal of Teacher Education*. Vol. 37, No. 7. pp. 14–29. <http://dx.doi.org/10.14221/ajte.2012v37n7.4>
- Varma, P. June 29 2018. Rejuvenating Public Education in Kerala. *Peoples Democracy*. 30. Retrieved from <https://peoplesdemocracy.in>, accessed on June 4, 2020.
- VUMILIA NGEZE, L., U. KHWAJA AND S. IYER. U. K. (2018). Cascade Model of Teacher Professional Development: Qualitative Study of the Desirable Characteristics of Secondary Trainers and Role of Primary Trainers. *Proceedings of the 26th International Conference on Computers in Education. Philippines: Asia-Pacific Society for Computers in Education*. pp. 755–760.
- WEDELL, M. 2005. Cascading Training Down into the Classroom: The Need for Parallel Planning. *International Journal of Educational Development*. Vol. 25, No. 6. pp. 637–651. <https://doi.org/10.1016/j.ijedudev.2005.03.004>

Nidhi Gulati, University of Delhi
nidhi.a.gulati@gmail.com

Righting Wrongs: A Handbook of Child Rights for Teachers

Introduction

The book *Righting Wrongs* engages with child rights. It focuses on key developments in law, policy and practices linked to child rights. The book attempts to highlight sociocultural practices, beliefs and conventions that lead to denial or violation of rights. Few books exist that engage with these concerns, particularly those that serve as resources for children and teachers. This text attempts to fill this gap, and is designed as a handbook of information, resources and activities for teachers to use with children in formal and informal settings.

The book is based on a year of research on human rights education initiatives. It interviews 600 students, 125 teachers, officials and activists from Tamil Nadu, Odisha, Gujarat and Karnataka. The handbook includes interviews of policymakers. It lays out the groundwork for a rights-based approach. Tracing the historical trajectory that laws related to children have taken, in the context of India and the United Nations, it attempts to situate laws in particular periods and contexts. The book discusses the interventions and strategies deployed by a few non-governmental organisations in ensuring that children get the rights they deserve. It includes a profile of people who have worked on children's rights, as a legacy of social action.

Each section is supported with data visualisations viz., timelines and milestones, display of key points, statistics and field-based vignettes discussing children's violation of rights. The vignettes appear as 'children's voice'. The author uses the

term 'case studies' that provide a glimpse into the many ways children's rights are not guaranteed to them. These also set the tone for child rights education and activism. It focuses on building an awareness in children so that they raise their voice against violations.

The text highlights the causes related to girls viz., prevention of female infanticide, prevention of discrimination, prevention of child marriage and girls' education. The violations linked to corporal punishment and children's labour are also included. The concerns related to Right of Children to Free and Compulsory Education Act, 2009; Prevention of female foeticide and infanticide following the Pre-Conception & Pre-Natal Diagnostic Techniques Act, 1994; Prohibition of Child Marriage Act 2006 and (its amendment in 2017) are included. However, the book has some pertinent misses. Recent debates and developments in the Juvenile Justice (Care and Protection of Children) Act, 2015; Anti-human trafficking, 2014; the National Food Security Act, 2013 and the Central Adoption Resource Agency guidelines have not been included directly in the text. Some of the laws that find umbrage under the Right to Life are also not discussed with a direct reference.

Universality versus cultural location

A glaring reality for India is the gap between the actual state of affairs and the legislation. Laws work in conjunction with each other. For instance, the Factories Act (1948) and the Prevention of Child Labour Act (1986, 2016

and 2018) have to be read together. Some child rights have fundamental contradictions, incertitude, lacunae and lack convergence. It is in the interstitial spaces between these acts, that there is scope for violations and for the violator to seek recluse. Yet, it is not the law per se which is the primary culprit in not guaranteeing any child his/her right, but its effective implementation in letter and spirit. It is here that the book places the role of children's participation activated and routed through NGO intervention.

The book begins with the premise that rights are universal, irrespective of socio-economic backgrounds. Instead, they are conferred depending on the child's sociocultural location. While there are children with privilege and those who live in abject poverty, there are those children too whose lives lie in between. The idea of a 'universal' applicable to all children takes away opportunities of debate and deliberation of intervention where it is needed the most. It influences what shapes and forms affirmative action can take. When the state makes a law, the test for the state is 'within what boundaries and over which peoples the state can enforce its legal will' (Hall, 1984, p. 2). The rights of the upper and the middle classes of society are more likely to be guaranteed. A case in point would be the Right to Privacy (2017). How does one guarantee this right to the many children (and their families) living on the urban street? What privacy can be accorded to them? Children living on the street do not have a home address and are therefore, bereft of any entitlements in the name of state welfare or guarantees. Children's rights do not exist independent of their families' socio-economic location. Who is at risk and whose rights will be violated are determined thus.

Lost opportunities

Similar to most other countries ratifying the United Nations Convention on the Rights of the Child, India followed suit. Like the idea of childhood itself, the rights are an import

from the European ideologies and notions. By ratifying the UNCRC on an 'as is' basis, India lost an opportunity to deliberate upon and think according to our own social economic realities. This influenced which 'needs' and 'vulnerabilities' are highlighted and which are left out. Wadia (2011) argues that children who need the state to intervene, get defined in terms of their needs, which fit the predetermined UNCRC categories of development, survival, protection and participation. The organizations that design programmes rarely question their conception of childhood or the UNCRC driven agendas. By appreciating the ratification of UNCRC by India, the book conveys a tacit and unquestioned acceptance of these received constructions of childhood.

How are rights guaranteed? The first guarantor of the right is the state through its various apparatus. For individuals to follow the law of the land, the state uses coercion and consent. How does the state ensure that there are no violations? The state enforces laws through its executive and judiciary functions and apparatuses viz., the police, inspectors, vigilance officers and the courts. Second, the state creates specific mechanisms and apparatus which play the role of a watchdog. The National Commission for the Protection of Child Rights and its state chapters, following the NCPCR Act, 2007 play this role primarily for the state. Third, the state creates awareness in society about the rights as well as implications of violations. It permits a playing field to the non-state actors to help serve this function. The book focuses on the latter two functions, with a concerted focus on 'awareness'.

Awareness is not as deep as knowing, where the latter leads to an empowerment. Once a child/person has a conception of the laws existing in the social world, such knowledge can be used to ensure their implementation. The other approach for social change can be drawn by examining its nature. Social change, as it may be visible in the community is a slow and tedious process. It does not ride piggyback on modernity and



its spoils, and is instead rooted in cultural ethos. The book mentions a cultural practice from Bihar, where parents plant trees for every girl born. The state can use cultural products to disseminate ideas and initiate change, for instance folk songs to create value for girls. The book advocates both these approaches indicating that as far as children's rights are concerned, the rational-cognitive approach alone has proven not to suffice.

How can rights be guaranteed?

In modernity, the child is considered emotionally priceless and therefore, any violation of a child's innocence and protection deems an uproar from society. However, this holds true for children from certain sections of the society alone. The child is also a citizen in potentia and therefore, the best candidate for citizenship training. These two different conceptions of childhood are at play when non-governmental organisations deploy children to create an awareness of child rights. We highlight three contentions at play here, particularly with regard to structure and agency.

First, while the children and adults of the community can be 'woke' to inform the State Child Rights Commission of the violations, they cannot promise or ensure any action on the ground or change reality. 'Coercion' through children's voice is not akin to the woman's voice, the subaltern voice. How do children, the one without democratic representation, raise their voice? Does the voice carry weight or the wherewithal to initiate change? The children from a school (catering to children from middle or higher class families) may perhaps have learnt empathy while participating in a day long exercise of rolling incense sticks (Bajaj, *ibid.* p 55), but what goals do such simulation exercises serve in righting the wrongs? Children's parliaments, watch-groups, awareness groups need to be clear in terms of what purposes they serve and the agendas they forward.

Second, children are aware of the politics of their situations and contexts. Children from lower caste and class groups know that school structures are problematic (Devi & Kini, 2005), that teachers often discriminate, that it's best to be silent in school. They know that going to the police may be counterproductive (Balagopalan, 2014; AIWGCCR, 2018). By citing instances where children approached (or threatened to approach) the police for help, the book takes a rosy face-value view and misses to see the actual state of affairs.

Third, children are not independent entities. Rather, the basic unit of governance is the family. Exactly how does the state intervene in the private space of the family to ensure child rights? How does the state apparatus exercise coercive power over the family so that in accordance to the customary practice, a girl-child is not married off before eighteen?

Children definitely speak for themselves and their voice should be heard. The 'children's voice' that the author advocates, where children speak for themselves and for other children— its location needs to be ascertained in a frame of larger political economic realities. We are contending with an increasingly minimalist neoliberal state, gradually withdrawing from all welfare and intervention despite increasing poverty levels. While the state backs off, children's voice and non-state action is pushed forward. What do these concomitant realities signal?

Complexities of age and gender

In the book, the violations of child rights include children in the age of 6–14 years. Two vignettes mention female infanticide, where one is about children preventing female infanticide in their neighbourhood and the other is a reminiscence of an adolescent girl. Another girl is discriminated against, not given an equal share of food (6-year-old). Girls in the age group of 10–13 years face being married off and do manual work. They are denied education. An 11-year-old

girl who died as a consequence of corporal punishment by her teacher is also cited.

Three boys mentioned in the book are engaged in productive work in a restaurant (9-year-old and a 13-year-old) or a construction site (13-year-old). Two boys (aged 12 and 13 years) whose cases are cited are abused physically by family members, relatives and their employers. A 14-year old Dalit boy mentioned in the text faced discrimination and abuse because of his caste identity.

It appears as if there are differential violations at work, based on age and gender. The girls are vulnerable as infants and then need special attention from 6–13 years of age. Girls need to be protected from being killed, provided food, nutrition and education and prevented from doing manual work. This emphasis captures the stark number of missing girls and women, in terms of missing female births and excess female deaths. The boys are vulnerable from age 9 onwards. They need to be kept away from paid work in the informal and formal sectors, protection from physical abuse and prevention of discrimination due to their caste and class identities. Both of them need provision for the right of education.

The book misses to mention crucial child rights even though the incidence of their violation is quite high. It does not mention the rights of children with disability. The text cites that the productive work children participate in is in restaurants, factories and homes. The fishing, carpet, mining, agriculture, brick-kilns are the highest employers of children between ages 7–14 in dangerous work, even though their participation is down to 1.70 per cent in 2012 from 5.20 per cent in 2000 (Nieuwenhuys, 2005; World Bank Report, 2016). A large number of children under the age of 18 (1.34 billion) are victims of human trafficking (ibid.), begging or are victims of state and military oppression or insurgent movements.

The vignettes highlight schools and workspaces as violent spaces. What the

book misses is that abuse in the private space of home and bullying by peers are realities that children face across their social class. Children are particularly vulnerable to sexual abuse, which includes touching, physically forced sex or unwanted attempted sex. This reality is hidden in plain sight (Ospina and Roser, 2017). It is hushed in most cultures, particularly Indian. Not many children report sexual crimes and boys even less so. Sexual crimes for younger boys are higher than those against girls, and the crimes against girls tend to be more violent. Newspapers and self-reported victimisation are an indication of how common sexual abuse is. While there has been an increase in its severity, frequency and reporting, there has been a concomitant increase in silences. The protection that needs to be guaranteed in this regard cannot be underscored enough.

Children in the age-group of 14–18 years have the highest out-of-school rate. This rate is higher for boys, particularly minorities. They also participate in productive work. These adolescents are subject to systemic and symbolic violence both in and out of school, and are most vulnerable to violence and sexual crimes. The laws in our country do not address the concerns of children beyond age 14, rendering them invisible. Apart from inadequate legislation, the non-state action is also lackadaisical. Where child labour, discrimination at school and child marriage are concerns faced by children across lower social classes, sexual crimes and violence is reported from all social classes. There is a tendency of the non-state actors to focus on certain vulnerabilities, certain social class(es) and ignore others.

The differential bracketing of vulnerabilities and needs as captured by the programmes and agenda of the non-state actors and civil society may not be intentional. However, a closer and critical examination of how social-cultural sensibilities of childhood shape and address childhood in limiting ways needs to be interrogated.



Conclusion

The book misses an opportunity to engage with several pertinent concerns. The first miss is not locating the rights in needs-based assessment and a reality check. It does not subject the statistics to close examination. It does not lend an ear to children's voice's elsewhere, who want to learn at school, acquire a skill, to live together in groups and stay away from the police (AIWGCCR, 2018). The book also misses to engage critically with scholarship in the area of childhood in the Indian context. Had these misses been attended to, perhaps the book would narrate a different story.

A crucial miss is critical understanding of how implementation of rights can be ensured. The enforcement of children's rights, just like other rights of the citizens is through the state apparatus. The 'state of affairs' that leads to guaranteeing rights is linked to local structures, local administrative levels and their functioning. It is at these levels that awareness raising and knowledge dissemination should happen. When advocacy for children is made the prerogative of children, a deeper

understanding of 'what works in society' and 'how it works' is obfuscated.

All texts dealing with child rights need to reiterate the role and responsibility that the state needs to play in guaranteeing them. To ensure that the state is directive, interventionist and has not merely ratified conventions and passed legislation, NCPCR and its state commissions need continued strengthening, especially at the local levels where power plays out differently. For the improvement of living conditions, achievement of social justice and equality, the state needs to be interventionist. The curbs on intervention and reduced welfare of the neoliberal capitalist state and the onus on individuals to change social realities are a dangerous coupling. The state has awakened expectations by passing these laws, yet unless its local power structures are set in motion to meet them, the promised rights become untenable. A translation of rights can only unfold when children's voice (and that of their families/networks) and participation is augmented through deliberate and concerted state and non-state action. Until then, the promises would continue to get mired in perils.

References

- ALL INDIA WORKING GROUP FOR CHILDREN IN CONTACT WITH THE RAILWAYS. 2018. *Life World and Agency of Children in Contact with the Railways: Results of a Research Study*. New Alipore Prajaak Development Society, Kolkata.
- BALAGOPALAN, S. 2014. *Inhabiting Childhood: Children, Labour, and Schooling in Postcolonial India*. Palgrave Macmillan, New York, NY.
- DEVI, M. AND K. KINI. 2005. *The Why-Why Girl*. Tulika, New Delhi.
- HALL, S. 1984. The State in Question. *The Idea of the Modern State*. Open University Press, New York.
- NIEUWENHUIS, O. 2005. *Children's Lifeworlds: Gender, Welfare and Labour in the Developing World*. Routledge, London.
- ORTIZ-OSPINA, E. AND M. ROSER. 2017. *Violence Against Children and Children's Rights*. Our World in Data.
- WADIA, H. 2011. *Confining Childhood in India*. Web accessed on 16 July 2014.
- WORLD BANK. 2016. *Understanding Children's Work*. Project based data from ILO, UNICEF and the World Bank.
- Accessed from <http://data.worldbank.org/data-catalog/world-development-indicators>

Mr. Denny John. K
johndennyjohn@gmail.com
Dr. P. S. Sreedevi
devidharan@gmail.com

Effect Of Social Media Enabled Learning In Enhancing Achievement In Physics At Higher Secondary Level

Abstract

The technology is advancing day-by-day. The advent of new millennia has brought tremendous changes in all the fields. The spread of COVID-19 has drastically affected human lives as well as the global economy. The after-effects of this deadly disease have reached the education sector too. Technical advancement urges for experimenting new technology in the field of learning and teaching pedagogy, to help overcome the present crisis. Social Media Enabled Learning (SMEL) provides a massive opportunity in the education sector. This study deals with the application of WhatsApp—a user friendly social media platform, as an educational tool, to provide learning experiences and assess the achievement of students in physics at the higher secondary level. Keywords: Social media, Social media enabled learning.

Introduction

The school curriculum was always subject to a change due to the developments occurring in the technological methods. Usual conventional strategies during this modern era is not completely enough in imparting the concepts of studies. Social media is one technological discovery in the last decade which has affected all aspects of human life. This can be attributed to user friendliness and ease of access of these social media technologies. The effect of social media is also evident in the education system. Researchers around the world are interested in exploring the promises and potentialities that these social media technologies can bring in the education system. Social media can be considered as an open source of information and knowledge sharing platform. The educators can leverage the potential of social media technologies to enhance the overall teaching-learning process.

This study focusses on social media enabled learning using WhatsApp, a platform that provides students access to useful

information and connects them with learning groups that make the overall learning process more interesting and engaging. It provides a social channel for collaborating, networking, sharing and generating knowledge and content, something which is of great value in the context of education.

Definitions of keywords

SOCIAL MEDIA

These refer to the computer-mediated technologies that allow the creation and sharing of information, ideas, career interests and other forms of expression via virtual communities and networks. Social media uses both web-based and mobile technologies on smartphones and tablet computers to create highly interactive platforms through which individuals, communities and organisations can share, co-create, discuss and modify user-generated content or pre-made content posted online.

Social Media Enabled Learning (Smel)

This is an instructional strategy in which learner learns with the help of social media. It helps the learners to achieve the desired instructional objectives at their own pace and abilities. In the present study, social media enabled learning strategy for higher secondary education has been developed with self-instructional modules administered through WhatsApp.

Significance of the study

With the advent of internet technology, social media has become an integral part of every student's life. With the help of social networks, it is easier and convenient to exchange information, communicate with each other and stay connected. The teachers and students are, thus, virtually connected with the help of the social media platform. This strategy is highly effective when students are not in a position to attend the schools regularly due to pandemic or disasters.

In this study, a platform is created for the students through WhatsApp groups which empower them with opportunities to improve their leaning process. This can make learning more interactive and inclusive. With the aid of Social Media Enabled Learning (SMEL), the achievement of students in physics at higher secondary level is assessed.

WhatsApp is a social media application that emerged among the technological platforms which is user friendly and provides transferring of media even low network coverage area. It paves way for a new age learning which is personalized and customized to suit the need of every learner, thereby improving collaboration and active learning.

Objectives

1. To develop social media enabled learning strategies to enhance achievement in physics at the higher secondary level
2. To compare the effect of social media enabled learning and activity-based

learning in physics at the higher secondary level

Hypotheses

1. There is no significant difference between mean pre-test achievement scores of the experimental and control groups in physics at the higher secondary level.
2. There is no significant difference between the mean post-test achievement scores of the experimental and control groups in physics at the higher secondary level.

Methodology

The investigator administered an experimental study to. A pre-test post-test parallel group design is adopted for the study.

Population and sample

As per the experimental design, two schools were selected from Kannur district of Kerala through a random sampling method. Each school had a control group and an experimental group consisting of 60 students each. The criteria of selection for both the control and experimental groups from both schools was done using the cluster sampling method. The sample of the research study thus is 240 students where 120 of them are from each school.

Tools used

- A social media enabled learning module was developed and administered among the experimental groups under study. The students in the control group were taught by activity-based approach of learning.
- Achievement test (pre-test) in physics was conducted on both the control and experimental groups before the experiment.
- Achievement test (post-test) in physics was conducted on both the control and experimental groups after the experiment.

Implementation of SMEL module

The investigator designed the study module in such a way that the concepts can be taught in an interesting environment and that students are able to retain the materials of study with much ease. The topic was finalised based on the conclusions obtained from the discussions with the higher secondary physics teachers as well as Class XI students not included in the sample to identify the difficulty level. The investigator selected WhatsApp as the platform to impart instruction of the contents. The selected two units have 24 hours of instruction considering that total hour of instruction of the two units have been divided into modules for a duration of 8 weeks.

The prerequisite in implementing SMEL is mainly a smartphone with adequate storage space for files, which is shared through the WhatsApp social media platform. An active internet connection is another important prerequisite to be considered when planning for the implementation of SMEL.

The modules are presented with self-made introduction videos, class videos, notes, texts, gifs, audios, simulations, links, examples, animations, model questions, problems, assignments, and other OER materials. In traditional training, the greatest effort is in the delivery of training sessions while in SMEL, it is in the design and development of structured materials which must be self-contained and able to be repeated multiple times without making ongoing adjustments.

A collaborative and combined teaching method was adopted for SMEL implementation where more than one teacher was involved in teaching. The learner can also contribute to the learning process then and there. There is a scope for discussion and clarification of doubts by teachers as well as a team of peers. This gives a learner the motivation to engage in the learning process. The content has been split into small modules and self-evaluation questions are provided at the end with immediate reinforcement. The backup of the content helped the learner to study at

their own pace. Each student can take their own time to study which is not practically possible in conventional learning.

The SMEL module can be used for effective classroom interaction and it is a constructivist tool to promote knowledge enrichment, self-study and skill development for students learning the science curriculum.

Statistical techniques used

Mean, standard deviation and t-test were used to conduct this study.

Analysis of Data

Table 1: Comparison of Pretest Scores of Achievement in Physics between Experimental and Control Groups

Pretest Scores	N	Mean	S.D.	t-Value	p-Value
Control group	120	34.70	6.62	0.010	Not significant
Experimental group	120	34.71	6.58		

Table 2: Comparison of Post-test Scores of Achievement in Physics between Experimental and Control Groups

Post-test Scores	N	Mean	S.D.	t-Value	p-Value
Control group	120	25.12	8.20	7.148*	0.01
Experimental group	120	33.50	9.89		

*significant at 0.01 level

Results and Discussion

The pre-test scores of the achievement in physics for the total sample were compared for differences between the experimental and control groups, as presented in Table

1. The average pre-test score of achievement in physics of the control and experimental groups are 34.70 and 34.71 with standard deviation 6.62 and 6.58 respectively. The calculated t-value is found to be 0.010, which is less than 1.96 at 0.05 levels of significance. This shows that there is no significant difference between the pre-test scores of students in the achievement in physics. It means that the two groups did not differ significantly in respect of the initial academic achievement of the students.

Hence, it can be concluded that the experimental group and control group are more or less equal with respect to the level of achievement in physics before the experiment. The students belonged to a homogeneous group based on the achievement scores of both the experimental and control groups.

Table 2 shows the post-test scores of the achievement in physics for both the control and experimental groups. The average post-test score of the control group was 25.12 and that of the experimental group was 33.50. Also, the standard deviation in the post-test scores of the control and experimental groups was 8.20 and 9.89 respectively. The calculated t-value is 7.148 which is greater than 2.58 at 0.01 level of significance. It shows that there is a significant difference between the mean post-test achievement scores of experimental and control groups in physics at the higher secondary level. Hence, second hypothesis is rejected. The results revealed that there is an enhanced achievement in physics in case of students taught using social media enabled learning than that of activity-based approach of learning.

Educational implications

The present study can be concluded to state that SMEL is an effective tool in the development of scientific skills and learning concepts more interactively. It can be effectively used as a tool at the time of pandemic or in other situations of grave crisis when learners are forced to be kept

outside the campus. The instructional strategies used as part of SMEL should be included in the curriculum which thereby can enhance the learning capabilities of the students. SMEL strategies are equally good for teaching and learning of other subjects at the higher secondary level. The teachers should acquire necessary training in order to fully deliver the school curriculum with the aid of social media enabled learning strategies.

Delimitation of the study

Though the researcher has made every attempt to make the study imperative and comprehensive, it has certain limitations. The study was confined to two higher secondary schools from the Kannur district. It was limited to a sample of 120 higher secondary XI students. As modules were developed in English, the study was confined to English medium students. However, subject to constraints, an attempt has been made by the researcher to make the study as reliable as possible.

Conclusion

Educational methods have a positive impact due to random growth of technological advancements. Social media is the recent trend which has become the most common method and way of communication and exchange of ideas among the mass of people today. This new method trending among people have always put in discussion among researchers and their possibilities and impact in the field of education and learning. Social media enabled learning reframes the role of content in learning and refocuses the instructional design process away from the techno structure towards a focus on social interaction. The social media can be used as a tool for learning which inculcates a wide range of study interests among the students.

Social media enabled learning through WhatsApp create massive interconnection between students as well as teachers and create a virtual platform, for the exchange

of knowledge and interactive learning. The active participation of the students using student-centred teaching approach as well as collaborative method is the major highlight of WhatsApp learning. Teachers acting as an active moderator and instructor inside the WhatsApp groups can provide magnificent results in personalized

educational advancements. Social media involves the creation of digital habitats that will both define the focus on learning rather than content or technology. Thus integrating social media enabled learning with higher education can bring about fruitful changes in the learning curriculum.

References

- Arthur, Charles and Brafi Paul Osei. 2011. Internet Use among Students in Tertiary Institutions in the Sunyani Municipality, Ghana. *Library Philosophy and Practice* (e-journal). Paper 859. Retrieved from <http://digitalcommons.unl.edu/>.
- Chun-Yi Shen and Hsiu-Chuan Liu. 2011. *The Turkish Online Journal of Educational Technology*. Vol. 10, No. 2. pp. 140–150.
- Nielsen. State of the Media: The Social Media Report. 2012. *Featured Insights, Global, Media Entertainment*. Retrieved from 9, December 2012.
- Surly, Daniel W., Adrian G. Grubb, David C Ensminoer and Jenelle Ouimette. 2009. Implementation of Web-based Learning in Colleges of Education: Barriers and Enablers. Vol. 35, No. 3. Retrieved from <http://www.cjlt.ca/index.php/ejlt/article/view/543/266>.



Life History Method to Study Policy Changes and its Impact on Teachers' lives: Experiences, Dilemmas and Reflections

Abstract

This paper is based on the methodology used for the doctoral research that is, life history method to study policy changes and its impact on teachers' lives. The paper sketches out the process of data collection from the beginning to end. It throws light on the participants' views that is, teachers' views on the methodology used by the researcher. In the last two sections, the paper delineates dilemmas faced by the researcher and reflection on methodology and its dimensions which helped the researcher to navigate through teachers' lives to study the educational policy changes.

Introduction

The paper draws from the methodology of the doctoral research study conducted in Delhi, India to understand changes in educational policy and its impact on the teachers' work lives. The objectives of the research study are to examine current policy and the structural regimes within which teachers' practices are regulated. It attempts to understand teachers' interpretation of curricular and policy changes, and how the state's policy is impacting the school teachers' understanding of their role as professionals that is, how they perceive their work and lives. The participants of the study were primary school teachers of Municipal Corporation of Delhi of Shahadra south east zone. In order to fulfil the objectives of the study, the relevant documents related to policy changes like notices, circulars, and life history method were used to understand teachers' perspective.

The focus of this paper is to draw insights from the methodology of the research study that is, life history method. In the first few sections, the paper explains the life history method, and later sketches out the process of data collection using this method.

Life History Method For Examining The Impact Of Policy On Teachers

A multi-layered—national, state, district and school—examination was necessary to understand how policy changes were experienced by teachers. Goodson (2008) in his book, investigated teachers' lives and work and strongly recommended a deeper study of their lives. He described how teachers' lives were subject to various degrees of closure because they take place in one of the most historically circumscribed social spaces.

Schools are institutions regulated by various policies, guidelines and rule prescribing pedagogic interventions and accountability, as well as large-scale assessments (Goodson, 2008, p. 49) and various other aspects. Teachers also go through systematic and invasive socialisation during their education, pre-service as well as in-service training. According to Goodson, the post-modern way of understanding the teachers' selves that were free-floating and multiple, was subject to change and is constantly in flux, ignoring the "circumscribed spaces" and "socialized trajectories" of teachers' lives (ibid). Strategies for self-formation, therefore, take

place in juxtaposition with institutionalised and socialised schooling practices.

What is Life History Method?

It is a qualitative method to study the lives of social actors embedded in a particular social context. Sociologists not only admire it because of its relevance to study the lives of people and social relations, but it has become much more significant in the current wave of neoliberalism in today's life. Life history is a narrative research in which participants express their opinions, perceptions, and the critical events and stories of their lives. It is like an ongoing project, where social history and social geography of situations play a large role in terms of the participants' location and collaborations with others to contextualize and weave an inter textual commentary (Goodson, 2008, p. 55).

Why Life History Method?

It is well-known for bringing forth the voices of the participants, which would otherwise have remained absent, because it places people and phenomena at its centre. Life history is more than a life story because the aim of the method is to understand the patterns of social relations, interactions, and constructs in which the lives of humans/actors are embedded (Goodson, 2008, p. 54). Life history contextualizes, politicizes and pushes the question whether private issues are also public matters (Goodson 2008, p. 54). The participants raise issues which they consider as important, and the conversations are lengthy narrations in which they can speak their minds, locating themselves in a time and space chosen by them.

In the study, the teachers narrated episodes concerning their colleagues, inspectors, the school head, career choices, the significant people in their lives, students, and the parents of their students while they discuss the changes and how they locate themselves in a particular time and context. To study the changes in policy and their impact on the profession and its practice, it is necessary to study the teachers' lives in

relation to policy changes and educational reforms. According to Goodson and Sikes (2001), issues are seen as important in the life history method because (i) individuals have different views about their lives (such as their professional self or the child/parent self); (ii) there is an interactive relationship between perceptions and experiences of life, and historical and social contexts and events; (iii) life histories provide evidence of how individuals negotiate their identities, experiences and made sense of the roles (and rules) in social worlds in which they live.

In the context of studying policy changes from the teachers' perspective, three dimensions are significant:

1. Individuals have different views about their lives (such as the professional self or the child/parent self)

In the study, individual teachers had different views and experiences of their personal and professional selves because every teacher's life is embedded in a specific context (such as family and the institution they are part of) though there was common sense knowledge about their work, and the practice of teaching. Each teacher held a different view based on their ethics and principles, and different beliefs which guided their work.

2. There is an interactive relationship between perceptions and life experiences, and historical and social contexts and events.

Here, the teachers' perceptions and experience of the policy changes have an interactive relationship with the historical and social contexts of their profession. Their socialising process follows a trajectory that is influenced by unique historical and social roots. For example, the importance of textbooks and the examination system, which was established in the colonial times, are crucial to the lives of the teachers. This has implications on the teachers' understanding of changes in the curriculum and assessment practices. Their professional status oscillates between that of a lower rung government employee and an authoritative image of a

'guru', which is how teachers are perceived in the Indian culture. In the Indian context, there was an interactive relationship between experiences of life, and the historical and social context and episodes of teachers' life reflects how it operates in practice.

3. Life histories provide evidence of how individuals negotiate their identities, and how their experiences made sense of the roles (and rules) in their social worlds.

Each teacher in this study held a certain set of beliefs about being a teacher and the practice of teaching. The narratives reveal how these beliefs were formed, as well as how the teachers negotiated their beliefs in their daily lives. They also provide insights on how the teachers negotiate older identities at their workplaces, developing newer expectations of their work. This provides scope for tracing the exact changes that the teachers brought into their practice, and an understanding of what it means to be a teacher.

In the life history method, teachers narrate their stories as personal accounts. However, these stories would be located in the theories of context, and as social constructs which allow me, the researcher, to locate and interrogate the social world in which these stories are embedded.

Process of Data Collection

Introduction and Rapport building

The introductory meeting with the teachers was held at a school. Out of seven teachers, five agreed to speak at their homes or outside school. The timing for the meetings depended on the teacher's availability. One headmaster and a teacher wanted the conversations to take place at the school itself. A teacher (Manish) wanted to be interviewed during school hours because DIET trainees were taking his classes. The researcher insisted that the meeting be held after school and outside. Finally, the teacher agreed to be interviewed in a park and, later, invited the researcher to visit his home too. However, despite the researcher's efforts, the headmaster insisted that her interview be conducted in her office at school only.

The researcher would travel with the teachers to their homes (with their permission) which helped her to understand how a teacher reached school. It also gave the researcher an opportunity to break the ice and start an informal conversation. Initially, the discussions would be about their schooling, childhood and their family lives. This helped to build a comfortable environment for longer interactions as well as to understand each person's biographical context.

Recording of talks and conversations

Face-to-face conversations were conducted for collecting data. Informal conversations were also part of the methodology of study. All interviews and conversations were recorded in Hindi using a voice recorder. The conversations did not follow a set sequence. The flow was based on the issues that emerged from the long conversations and the topics that the teachers considered important. The teachers talked about their early career changes, trajectories of their work lives and contemporary issues.

The conversations covered the teachers' schooling, recruitment to their jobs, the enactment of the Right to Education Act and policies, the distribution of Mid-day Meals¹ at school, and other matters which impacted their teaching practice. They also spoke about the involvement of parents, salaries, leave and promotion policies, their colleagues and headmaster/mistress, the school inspectors, curriculum-related areas like assessment, textbooks, and other academic and para-academic work that they were required to perform. Also included in the teachers' narratives were the admission policies, election duty, the types of para-academic work, leave rules, work that women and men do, life episodes and experiences, feelings and opinions on various dimensions of their lives.

Focused attention and patient listening were key to gathering data and information.

1. Mid- day meals are provided by the state during break time of a day in public schools.

They also helped the researcher probe deeper for more meaningful information. Probing was a crucial aspect of the interviews. In many places clarification to answers were requested using words and phrases like “*matlab*”(meaning), “what do you mean by this”, “please explain it further”, “please elaborate”, “how”, “why”, “pardon”, “do you mean to say this”, “please clarify”, etc. These expressions helped to carry the conversations further and go deeper into the meanings and beliefs of participants.

Movements

The life history method provides ample scope for understanding movements from past episodes and how teachers operate in the present as well as in making internal connections between the different fields or contexts in which they live. Episodic conversations with the teachers revealed beliefs about their practice and evidence of practical knowledge. This gave the researcher insights on how the teachers’ professional and personal lives were not two distinct areas. For example, the teachers explained how they adopted some of the practices they had learnt from their teachers. The teachers also described how their expectations as parents impacted their practice. One teacher’s satisfaction with their profession inspired their children to become teachers.

These movements were insightful. Although they deviated from the focus of conversations, a careful and attentive listening helped the researcher in sustaining the discussion.

Another strategy was to keep a paper and pencil ready for writing questions or clarifications and making a note of cues that would be used for further probing after completion of the present argument or narration.

During interactions, the participants opened up, sharing views, perceptions and experiences. This researcher became a familiar figure with the families of the participants also. There were also discussions on personal matters, especially on issues

and problems that seemed to affect them at that time.

During the later stages, teachers gained a better understanding of the method of this research and its purpose, because of which they equally participated in deciding the flow. Often, the participant themselves would assert a point, mentioning ‘*yeh zaroor likhna*’ (you should write [about] this [in your thesis])

Teachers’ Views On Approach / Method Of Research Study

The approach to research was a new experience for teachers, especially about the time taken. Often, they had to sit through prolonged sessions. They had expected to have about three sessions of interviews.

There was a considerable amount of appreciation by the teachers for the method. This was mainly because the teachers felt that that they were being given importance, which was rarely their experience. In fact, as the teachers mentioned, no one had ever shown much interest in knowing about their professional practice and experiences. From one perspective, this was also a reflection of their isolated lives as workers and the hierarchies that are present in their profession.

The participants also shared their opinion that the life history method helped them reflect on their views and perspectives more deeply than they had before. The experience was a meaningful journey for them as they could talk about their lives and professional practice in a comprehensive manner. Teachers said that it was also an insightful journey for them because they could talk about their practice and profession in a more comprehensive manner than before. They could also reflect on the ‘why’ of their practice and why they thought in a particular manner, what kind of strategies they adopted, what were their beliefs about good students, the head master and teachers, etc.

The teachers also said they got to know about policies which they were not aware of



earlier. For example, they were not aware of the rules of assured career promotion and other employment-related rules till these were pointed out to them by the researcher.

A few teachers even expected that the thesis, after its publication, would make the government more aware of their work lives and bring in changes that will address the realities in their schools. One teacher, who had many ideas of bringing in systemic changes in the education system, hoped that this study would help in making her voice heard at the ministry level. However, it was repeatedly stressed that this work was only a doctoral study and that they should not entertain hopes and expectations of change.

The Researcher's Dilemma

Certain situations posed a dilemma, especially during the times that the researcher was asked questions related to her personal life. During the data gathering stage, the researcher got married, which became a matter of interest for many teachers. The researcher was asked about how she felt, her relationship with her in-laws, her husband, etc. Since the teachers had shared details about their lives, there was the expectation that the researcher would willingly share information about herself too. The researcher was constantly confronted with the dilemma—how much to share and when.

Even while they were talking about issues related to their practice, and professional matters, initially, the participants would look at the researcher for cues so as to seek her opinion. It was a challenge to maintain a neutral position (as expected of a researcher) in the face and not respond to the several *'don't you think'* and *'what do you think'* queries that were directed at her.

Reflections On The Life History Method

This research study used the life history method to examine the impact of policy changes in teachers' work life. The teachers

who were part of the study talked about their experiences of the ongoing work life and earlier life stories. This helped the researcher in tracing the impact of changes on their professional identity and work. The method helped to study the current context as well as the past episodes from which teachers' beliefs were formed. It helped immensely in reconstructing historical aspects of teachers' work life in which their identity was rooted and how it was affected or unaffected in the ongoing situations through their biographical accounts. Here the focus was to understand how teachers constructed the meaning of policy changes. According to Ball and Goodson (1986), the stories of teachers' work lives construed meaning and self-representation. Secondly, as mentioned above, this method allowed the movements in different operating discourses while conducting open-ended interviews. This methodology helped in tracing changes in teachers' work life and their 'voice' as an actor moving in the discourses of the past and present. Further one could capture how the larger contexts or the structural changes operated in teachers' life and how they, as an agent, interpret and implement these changes through their practice.

Casey (1995) writes: "Biography falls in the broad genre of narrative research which 'confirms the arrival of post-paradigmatic age'—an age that actively sponsors the voices of teachers, teacher educators and students; voices that have long been absent from education research and policy." (p. 235)

The major contribution of the methodology was to enable capturing the temporal aspect of teachers' life from stories of their initial careers to the current work life, teachers' own schooling experiences to teachers as parents. It further gave scope to study changes of the particular period when the teachers' work got intensified. Keltechermans (1993) has noted that the temporal dimension is one of the core strengths of the biographical approach and study of career stories. Using this method, he studied professional development of teachers by analysing the narrative data culminated

in reconstruction of the professional self and subjective education theory. He states: "Teachers' actual thinking and acting constitutes one moment, a fragment in a continuous process assigning meaning to the perceived and experienced reality. Professional environment thus also includes a temporal dimension. The biographical perspectives conceive of context in a special and temporal sense." (p. 444)

The different aspect of teachers' identity also got highlighted such as the teachers' relationship with their supervisors, teachers as pedagogues, and teachers as government employees. In this way, the life history method gave the scope of understanding changes in different arenas of teachers' work life. One

could also navigate through the linkages between these arenas of work life. Sriprakash (2011) in her research article examined the teacher's work story and efficacy of reforms in the state of Karnataka in India. Through teachers' work stories, she unpacked tension between demands posed by the reform processes and teachers' social status. She could reflect upon multiple shifting positions other than through teachers' narratives. She could bring out how the child-centered ideals got negotiated in teacher and authority relationship, bureaucratic regulations and teacher's social status in labour market. Hence, with this methodology, one was able to understand teachers' location in the historical, cultural and institutional context

References

- CASEY, K. 1995. The New Narrative Research in Education. *Review of Research in Education*. Vol. 21, No. 1. pp. 211-253.
- GOODSON, I. F. 2008. *Investigating the Teachers' Work and Life*, Rotterdam Boston and Taipei: sense Publishers
- GOODSON, I. F. AND SIKES. 2001. Studying Teachers' Life Histories and Professional Practice. In P. Sikes (Ed), *Life History Research in Educational Settings Learning from Lives* (57-74). Open University Press, Buckingham.
- SRIPRAKASH, A. 2011. The Contributions of Bernstein's Sociology to Education Development Research. *British Sociology of Journal*. Vol. 32, No. 4. pp. 521-539.



A Peep inside an Online Pre-Primary Classroom during COVID-19 Times: Some Reflections

This article briefly discusses some examples from the pre-primary classroom of a private school which serve to highlight the many ways in which a system continues to carry forward the conventional ways of educating young minds as against learning from theory and research from across the globe.

Keywords: Online classes, home language, gender, early literacy, stories, COVID-19

Introduction

COVID-19 presented a new challenge to the educational institutions, the first and foremost being- the urgency to maintain some form of continuity in the education of children during the lockdown. Amidst the many debates, perspectives and strong opinions for and against the virtual mode of education, private schools adopted it as the desirable strategy to keep running the cycle of levying heavy fees for 'quality' education even when the world had come to a standstill. Another agenda for this was to keep their staff on the job to justify the salaries they received.

As a parent, I also went through the anxieties of selecting a good school for my child which would provide holistic education to him. After a lot of surfing, talking to neighbours, family members, teachers in our friends' circle, we zeroed in on a school based on a few criteria, such as approachability from our home, an integrated curriculum with equal emphasis on co-curricular activities, and a balanced student-teacher ratio. The global pandemic made things tough for young children as well as parents; we were compelled to attend online classes for 40 minutes every day, much against the directives from the government for a shorter slot for pre-primary classes.

School is the most important site of socialisation for children after their homes. It is endowed with the responsibility of providing meaningful education to children as per the guidelines and aims of education defined in our National Policy documents. While the role of education as a quality of life-enhancing medium is highly endorsed, the way this process unfolds in schools requires closer scrutiny.

Online education gave us a rare opportunity to examine these processes while sitting at home, co-teaching our children along with teachers. At the outset, it must be understood that for teachers, it was a Herculean task to adapt their ways of teaching and interacting according to the needs of the virtual mode of education. For them, it meant undergoing a lot of training to be able to use online platforms and to create e-content for interaction purposes. Needless to say, teachers have done a commendable job of creating a routine for children. However, it is in these 'routinised' practices that one can observe and question the gap between theory and praxis of education. And, to these routinised practices, then, I turn my critical eye to examine how the teaching-learning programme of the school unfolded in front of us.

Place of Experiential World of the Child in the Classroom

To begin with, to those who could afford the agenda of online education, in terms of time and resources, this arrangement could mean breaking the rigid wall between school and home, thus, making the transition from home to school an easy and a facilitative one. One of the best mediums for this could have been the 'home language' of the child and the numerous experiences, stories and feelings woven and textured through it that could very naturally be made into a resource to establish rapport with toddlers whom the teachers have not met in person. The National Curriculum Framework 2005 states connecting knowledge to life outside the school as one of its guiding principles. A preschooler is highly observant and forms his/her understanding of the world with the help of his/her mother tongue or first language. S/he is equally curious to share her/his representations of the world with the significant adults in their life, such as teachers and their caregivers. However, in the online classes, we found an unwelcoming attitude towards learners attempting to interact with teachers in their home language. The assumption was that learners need to focus on school discourse as distinct from the primary discourse at home and the tool for establishing this distinction was English. In the bid to make these classes interactive, students were called upon one by one to share what they had learned from the presentation given to them. Children started talking about their family members, their friends, the toys they play with, the experience of eating something nice a day before and other such things. But, how can such inconsequential talk be the topic of conversations in such classes? And so, swiftly, the focus would shift on interrogating them on what has been 'consumed' as concrete learning from these sessions. Quite naturally, the expected language of answering would be English. It is not uncommon to find that learners struggled to blurt out memorised sentences

in English on even an extremely easy and a familiar topic of conversation while displaying very complex communication strategies of persuading, manoeuvring and negotiating when given a chance to converse in their mother tongues.

Learners' talk in the classroom

A related concern to the above is the promotion of presentational talk as against the exploratory talk in the classroom. Barnes (2008) distinguishes between functions of presentational talk as the one adjusted according to the needs of the audience and exploratory talk—the spontaneous, broken, hesitant kind of a talk that children use to process their understanding and share it with others. While both kinds of talks have their respective merit, Barnes (2008) argues that during the initial stages of learning, exploratory talks enable children to interrelate new knowledge with the existing one and work on their understanding. Presentational talk, on the other hand, is directed towards producing 'right' answers according to pre-set expectations.

In our observations, students were mostly invited to indulge in presentational talk. The structure of the classroom largely remained fixed to the introduction of new information, sometimes in a contextualised manner, sometimes totally isolated response generation by teachers by calling learners one by one to reproduce what has just been introduced and subsequent evaluation of these responses then and thereby commenting on how well the learners remembered, how clearly they spoke and how many sentences could they weave together in English. The assumption behind this kind of routine is perhaps that learners think in a linear manner. How can we forget that any new idea or concept for children brings to the front an array of new questions and observations? Unless enough space and time is given to learners to process this disequilibrium between their existing schemas and the new information, learners may not yet be in a position to



express it coherently. Unfortunately, the idea of 'quality' education here does not endorse the idea of letting children learn at their own pace, giving them sufficient time to formulate their understanding. The school has also started organising speaking activity weekly, where learners are required to present 3–4 lines on a given topic. There have been many days where the learners have presented stories, poems, lines, slogans but not a session where they could indulge in talking to the teachers for interactional, personal or representational purposes. This gradually links up with how students would be judged and assessed by the institution. Through different ways, direct and subtle, the school has been successful in instilling a sense of competition among students.

Initiation into Reading

The school follows *Jolly Phonics* as the instructional programme to teach early literacy skills to children. On the website of this programme, it is mentioned that "it uses the synthetic phonics method for teaching the letter sounds in a way that is fun and multi-sensory." The programme may have its own merit as it tries to introduce sounds in a contextualised manner, with an action associated with each sound and a visual clue for the letter formation. However, the way it is explored in the classroom needs attention. The programme has been developed in some other country by educators situated in a very different sociocultural milieu. Quite naturally, the programme uses such contexts for stories which are familiar to the western world such as families visiting a castle in Spain and dancers clicking castanets. However, the same fixed story got recounted to children to introduce the sound 'ck', that is /k/ without any adaptation to the context or the vocabulary of the story whatsoever. One feels the anxiety of the school in making learners recognise as many sounds as possible in the shortest time possible as if to make up for the lost time due to COVID-19.

Theory and research in early literacy suggest a holistic approach towards the

development of literacy skills during the pre-primary and primary grades. In addition to a sustained emphasis on graphophonic instruction, there has been equal stress on building a sense of functional aspects of print. The thrust of the research has been in suggesting the inter-related manner in which the notions about literacy development among young children. Phonological awareness and scriptwriting emerge over a period of time as a result of continuous engagement with meaningful print, such as interesting children's literature with the help of various activities, social interactions and some instructions in letter-sound correspondence. The underlying principle of such suggestions is the understanding that learning to read is a social and cognitive activity and not just a mechanical one. Hence, it can be argued that introducing words which are absolutely outside the domain of comprehension for a nursery kid and over-reliance on a phonic approach to teach reading in an isolated manner without focusing on functions of literacy make the programme unworthy for Indian kids. An associated concern is about making the curriculum somewhat alien to the experiences of children. Once while giving a presentation on 'dogs', seemingly to lead towards a craft activity of making a dog, the teacher shared some facts about dogs and names and pictures of some breeds. My child's question during the class was, "Where are the dogs that we find in our neighbourhood?" because he could not recognise any of the foreign breed of dogs that were shown in the presentation and there were none from his local context.

The World of Stories

Every parent would vouch for the magical effect that stories have on toddlers. Stories where animals are talking, stories of a tussle between a strong and a small animal, stories of adventures in faraway lands, unusual situations, elements of fantasy, magic and enchantment together make listening to stories the most favourite activity for children. The power of stories lies in the

vivid narration of events with gestures and sound modulation, their ability to play on the imagination of children, the parallels that children can draw from the lives of characters with their own lives and the sense of everything getting resolved at the end. Stories have a very special place in the kindergarten curriculum. It is one of the best mediums to promote active listening skills, to introduce new vocabulary in context, to develop anticipation skills in children and to broaden the horizon of thinking (Kumar, 2011). However, in a country like ours, which abounds in a great variety of stories, schools can conceive of just one purpose for using stories in classrooms, and that is, for teaching morals. The flourishing market of authentic children's literature also has failed in convincing schools about the power of exploring stories and literature for developing an organic interest in reading and listening to stories. The stories so far read aloud from children's books or narrated in my child's classes were explicitly chosen to emphasise the moral values such as cleanliness, giving respect to elders, always following commands of parents, not being playful with others, and a friend in need is a friend indeed. The teachers usually use a digital version of the story, and instead of letting children comprehend the stories at their own level, focus on the morals directly. After the story gets over, there begins the routine of asking comprehension questions from the story, the most popular being, so, what did you learn from this story. This misplaced emphasis on stories for moral lessons discourages children from seeing stories primarily as narratives of adventure, fun and entertainment. To me, this is killing the joy of listening to a story for its own sake!

Presentation of Gender Roles

Yet another concern I felt during these classes was about the way gender roles were presented to young impressionable minds. We have tried our best to raise our child in a gender-responsive way. Sharing responsibilities, doing chores together,

encouraging our child to pick up different gender roles in a role play, getting all kinds of toys without labelling them as being meant for 'girls' or 'boys', and above all, not emphasising the gender our child should identify with. However, in classes, we found many instances of gendered identities getting highlighted for children. Compliments for girls for their dresses, headgears, and their sweet nature came often. Comments such as all boys' favourite toys are guns and cars were made. The choice of curricular material, such as the use of the rhyme "Mummy ki Roti Gol-Gol, Papa Ka Paisa Gol Gol" to be recited in class, somewhere hinted at the role of mothers in the kitchen and that of the fathers in the market space. Through the use of a rhetorical question "Who cooks yummy and tasty food for you at home?" asked during a class on the topic My Family, followed by the routine answer, "Mumma, Na?", the teacher reinforced the gendered roles for all women, forgetting that her own identity goes much beyond just being a mother who cooks food for her children and that she is also a professional much like many other parents. This stereotyping continued in further discussions in a life skill class, where another teacher, while, giving a lecture on table manners, reiterated to the children the need to thank their mother for preparing yummy food for them.

Additionally, it has been observed that a similar lack of critical thinking is applied while selecting 'texts' to be read aloud to children in the class. The favourite texts for this purpose have been *Bruno Early Reader Series* and *Pepper Series*. Unfortunately, all the stories shared so far from these books have tended to represent women's role as that of primary caregivers and the one responsible for teaching "good manners" to children. Women are shown to be indulging either in shopping, cleaning the house or taking care of the children. Fathers are conspicuously absent from such books. Further, a video was shared on "healthy food" to be shown to children and have a discussion at home. This video also fixes a woman's identity as that



of a mother, concerned about her children's unhealthy food choices. The father comes into the picture only when there is a need to meet the principal of the school in which their children study. All such instances undermine the role of education as a tool to question and engage with the existing gender disparity.

To conclude, it is important to look closely at the experiences provided to children by schools especially during their early literacy phase. Along with the overall learner

achievement, one needs to examine the day-to-day processes that a child goes through in a school which constructs his sense of self and the world. Building a child's positive relation to his language, development of aesthetic sensibility towards literature, activating active listening skills, creating ability to communicate spontaneously without inhibition and instilling a sense of equality with children of other castes, classes and genders are crucial objectives that cannot be pursued without criticality.

References

- Barnes, D. 2008. Exploratory Talk for Learning. In N. Mercer & S. Hodgkinson (Eds.), *Exploring Talk in School: Inspired by the Work of Douglas Barnes* (pp. 1-16). SAGE Publications Ltd, London.
- National Council of Educational Research and Training. 2005. *National Curriculum Framework 2005*. NCERT, New Delhi.
- Kumar, Krishna. 2011. *What is Worth Teaching?* Orient Blackswan, Delhi.

Shruti Chopra
srhythm7@gmail.com
Abhishreya Sasan
sasanabhishreya@gmail.com

Stories as a Pedagogical Tool for Teaching-Learning of Basic Astronomy

Abstract

The study explored the influence of story-telling on primary grade learners' intuitive conceptions about the relative movement of the Sun, Earth and Moon (SEM) and related phenomena (day and night, phases of moon). It was observed that learners possessed a great deal of narratives heard or read from various sources as Sun, Moon and other planets are deemed to be of religious importance in the Indian context. These alternative conceptions differed significantly from scientifically accepted conceptions. Also, learners had little to no understanding of the actual cause-and-effect relationship involved in the phenomena. Designing and enactment of modules to address these preconceptions using story-telling as a pedagogical strategy enabled learners to establish scientifically accepted conceptions, which were assessed using questionnaires and rubrics.

Keywords: Astronomy, story-telling, primary grade learners, pre-conceptions

Introduction

Knowledge about learners' ideas has been recognised as an essential component of teacher knowledge (Shulman, 1986). For designing effective learning environments that contribute to conceptual understanding, teachers must be aware of the learners' preconceived notions, learning difficulties, domains of interest and alternative conceptions. According to the constructivist approach to learning, new knowledge is actively constructed by an individual by the complementary processes of assimilating the new information or accommodating schemes to adjust the incoming information. Viewing learning from this perspective requires a paradigmatic shift from the traditional pedagogical approaches where learners are perceived to be 'empty vessels' to be filled with scientific knowledge to learner-centred teaching-learning. National Curriculum Framework 2005 (NCF 2005) calls for the need to embed teaching-learning processes within the learners' experiences and context. This view recognises that children have naïve

ideas about various physical phenomena. These ideas are formed due to the everyday activities that a child engages in as part of his/her sociocultural milieu, such as fictional stories given in textbooks, folklore, media exposure in the form of cartoons, movies, etc. However, these conceptions might be in contradiction with the scientifically accepted ideas and recognising these alternative conceptions is integral to bring about a conceptual change. Pointing to the tenacity of the preconceptions, Ausubel (1968) claimed that these naïve ideas are resistant to change. Promoting conceptual change requires designing of effective learning environment that allows learners to become cognizant of their existing ideas and address their deeply embedded pre-suppositions through engagement with external representations and models (Vosniadou et al., 2001). This requires the teacher to provide opportunities to learners to express themselves and share their conceptions. Pintrich et al. (1993) argued that apart from the cognitive factors, the motivational beliefs of students and the classroom context plays a significant role in

inducing conceptual change. Motivational factors including learners' interests, choice of a task, persistence at a task, control beliefs and self-efficacy are important in influencing learning in the classroom (Pintrich et al., 1993). Storytelling is one such pedagogical tool that manages to engage learners with educational experiences that interact with their emotions as well as their intellect (Joubert et al., 2019). It allows learners to engage with the content through the powerful visual imagery which enables them to make personal and emotional connections (Morgan and Dennehy, 1997). Moreover, storytelling can be a powerful way to nurture engagement with science as it offers a meaningful context to conceptualize scientific ideas by encouraging emotional, imaginative and analytic responses (Banister & Ryan, 2001). Being an effective medium of communication between the teacher and the learners, stories stimulate vivid images in children's minds and help them grasp content more engagingly.

Introducing astronomy at the elementary level to young learners promotes their curiosity and nourishes their imagination around the naturally occurring phenomena such as day and night, our place in space and time, and existence of stars (Plummer, 2009). We teach calendars, time and directions starting from a young age to learners and many research studies have pointed out that the learners have various conceptions relating to basic astronomy which are acquired through personal experiences and media. Astronomical concepts and images have a universal appeal, inspiring wonder and resonating uniquely with human questions about our nature and our place in the universe. This widespread interest of children in astronomy can be tapped not only to enhance their knowledge but also to illuminate them on the nature of science.

Against this backdrop, the present study explores the possibilities of using stories for teaching concepts related to basic astronomy in the context of a primary classroom.

Research Questions

The following research questions guided the study:

1. What are the intuitive ideas of primary school learners about the concepts related to basic astronomy?
2. Can these intuitive ideas be addressed to build a scientific understanding about basic astronomy in a primary classroom?
3. How can storytelling be used as a teaching strategy to develop scientific understanding about the concepts related to basic astronomy?

Context of the Study

This research study was conducted during a 4-month long teaching internship in a government school as part of a teacher preparation programme, namely, Bachelor of Elementary Education Programme offered by the University of Delhi. This study was conducted with 26 learners of Grade 4 studying in a government school of Delhi, India. Most of the learners belonged to economically weaker sections. The learners learn about calendar, time, seasons, space travel and many more related ideas as part of the primary school curriculum. They are exposed to these ideas through children's literature as well. However, no formal, explicit attention is given to the scientific reasons and causes for such physical phenomena. The researcher, during her classroom interactions, observed that learners had various conceptions about basic astronomical concepts acquired through variety of formal and informal experiences. This study used a qualitative approach to probe children's thinking about the astronomical concepts within the context of the curriculum of Environmental Studies.

Data Collection

The complexity of classroom processes cannot be captured by a single instrument. Particularly, an assessment of the learners' understanding requires a combination of

approaches that can collect information about the learners' thinking. In this regard, data was collected from multiple sources including classroom observations, focus group discussions (FGD), learners' drawings, questionnaire and rubrics. Learners' preconceptions on the concepts related to the relative movement of the Sun, Earth and Moon and related phenomena (space and time, Cause of day and night, relative movements of Sun, Earth and Moon, and phases of Moon) were probed through focus group discussions and representational diagrams. For FGDs, groups of 6–7 learners were formed randomly. Along with verbal participation, learners were allowed to draw their interpretations of the world around them. They drew diagrams and gave verbal explanations for the same. These diagrams were assessed by the researcher/teacher using a rubric. The responses of the learners were recorded and later transcribed verbatim. A rubric was used to assess the representational diagrams in terms of the learners' notions of proportion and positioning of the celestial bodies in relation to each other and animistic thinking. This was followed by design and enactment of an intervention planned with the learners, which included storytelling sessions followed by activities to reinforce their learning. A structured questionnaire was designed and implemented to assess the change in conceptions of the learners after the formal instruction. During the intervention, several stories including the adapted version of *The Story of Time* by Nita Berry, *What Makes Day and Night* by Franklyn M. Branley, the adapted version of *Time to Shine* by StoryBots, *Earth's Tilt* by NASA and a picture book titled देखो चाँद by S. Rao & Marudu were taken up with the learners and a checklist was used to keep track of learners' participation in storytelling sessions conducted throughout the learning cycle. Interaction with the learners was recorded during these sessions and transcribed later. Rubrics were used to assess learners' performance in various follow-up tasks of the storytelling sessions.

The objective was to look for their concept clarity, their thought process in the selection of objects to represent celestial bodies, the accuracy of those objects and the space vocabulary they employ in order to explain the concept. In the post-instruction phase, a structured questionnaire was designed and implemented to gather information on the understanding of relative movement of Sun, Earth and Moon and related phenomena. The questions included a number of diagrams and concept cartoons as the pedagogy was centred around developing visual mental models using stories.

Data Analysis

The data collected from the responses of the participants in the pre-instruction focus group discussions and the post-instruction questionnaire was classified, tabulated and analysed qualitatively. These were correlated with the participants' pictorial representations for an in-depth understanding of their conceptions. The data collected was descriptive and captured viewpoints of the participants. The responses were organised according to themes predefined during the course of the study based on the astronomical concepts addressed. The responses of participants falling into the respective categories were recorded.

Results

The focussed group discussions revealed that the learners have preconceptions regarding all of the phenomena relating to the characteristics and the relative movement of the Sun, Earth and Moon. The preconceptions were categorised under various sub-themes such as notions about Sun and Moon, the concept of shadow, the day and night, and the phases of Moon.

Notions about Sun and Moon

The learners perceived Sun and Moon to be god-like figures created by nature. They believed that Sun, which emits heat, is a



grumpy celestial body since it is always hot, and Moon is the calm one because it always provides us a cool atmosphere at night.

Table 1: Frequency of Learners' Preconceptions about Sun and Moon

Preconception	Frequency
Moon is a star because it is made up of many small stars	04
Moon shines white and sun gives yellow light, white ones are stars	24
Sun and Moon are gods, Sun, a grumpy one and Moon, a calm one	17
Sun shines in the morning and moon shines at night	25
Moon used to shine before but then Lord Ganesha cursed him	02
We live on a planet called Earth	26
Earth only rotates; it doesn't revolve	23
Earth revolves around both Sun and Moon	03

Table 1 lists the learners' preconceptions that emerged during focussed group discussions. All learners except one said that Moon gives its white shine at night and Sun gives it yellow light in the day. On the other hand, two learners believed that Moon used to shine but after Lord Ganesha's curse, it lost its shine. Hence, there is no light it emits. When asked if Sun or Moon is a star, 24 learners responded that Moon is a star because stars are white in colour, and 4 of these learners further said that Moon is composed of numerous small stars taken together. These responses illustrated their unfamiliarity with the relative sizes of the celestial bodies. Learners' conceptions were found to be based completely on what they were able to observe with the naked eye and stories they had been told in their community.

All the learners were aware that the Earth is in some sort of motion. Most of the learners (23) believed that it only rotates and 3 learners insisted that it only revolves around

Sun and Moon. All the learners ruled out the possibility that Earth could possibly be rotating as well as revolving. Diagrammatic representations showed that no learner could depict the correct relative position of the three celestial bodies in the solar system. Apparently, it was observed that 16 learners out of 26 thought that the Sun, Earth and Moon were living beings and drew features of human beings such as facial expressions, hands, etc. on these celestial bodies. Only 1 student could identify the correct proportion in size of these 3 bodies. (Figures 1 & 2)

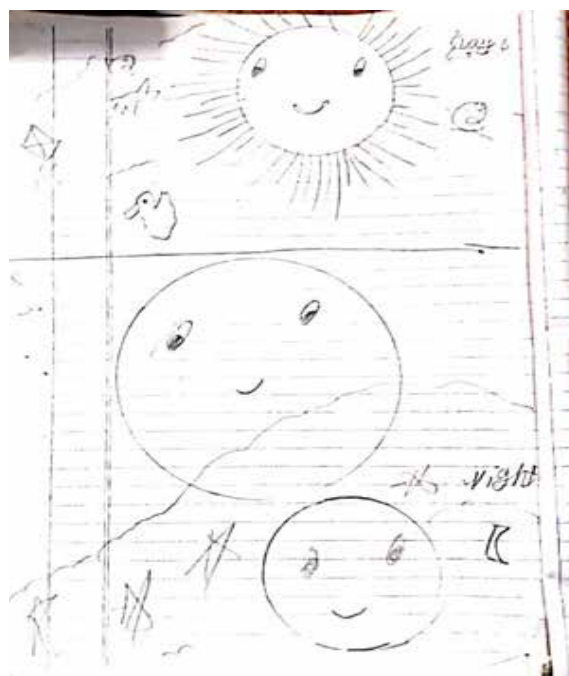
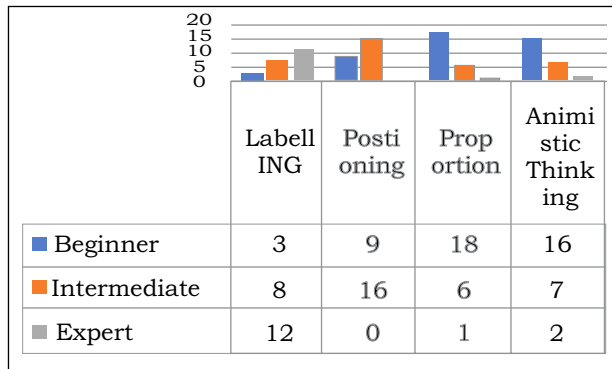

Fig. 1



Fig. 2



Rubric 1

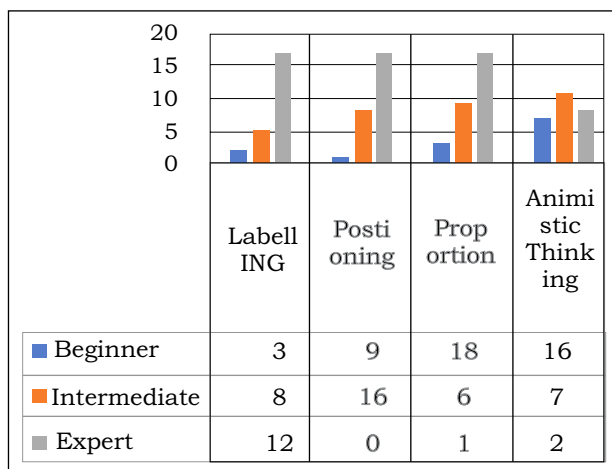

Rubric 2

Students' diagrammatic representations of relative movement of Sun, Earth and Moon before (Rubric 1) and after the intervention (Rubric 2).

The assessment of the change in students' ideas following the intervention showed a shift in the learners' understanding towards scientifically accepted ideas (Rubrics 1 & 2). As illustrated above, out of 26 learners, 17 were able to label the diagrams and position all the celestial bodies correctly (Figures 3 & 4). They were able to label Sun, Earth and Moon and represent their relative position in the solar system. 30 per cent learners showed the positioning of only 2 celestial bodies correctly (Figure 5). 14 learners drew all the models proportionate to each other. There was considerable progress in terms of labelling, positioning and proportion but 69 per cent of learners still displayed their animistic thinking as they assigned human like characteristics to one or more of the celestial bodies (Figures 3, 4, 5).

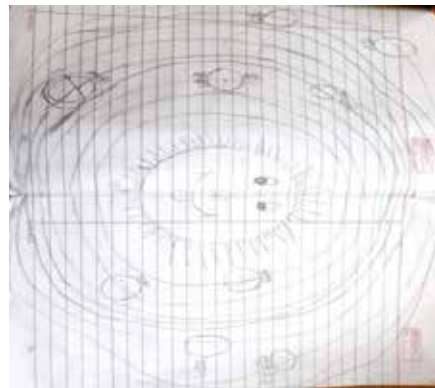

Fig. 3

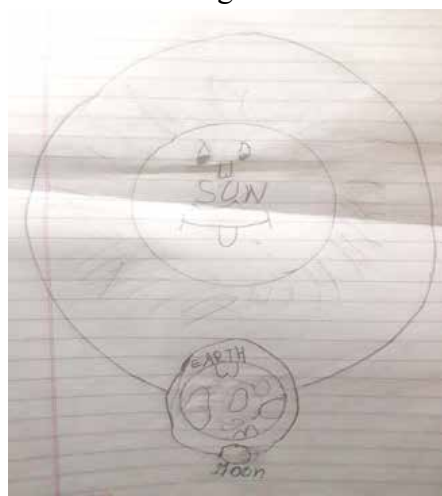

Fig. 4



Fig. 5



Table 2: Learners' Conceptions about Sun, Earth and Moon in the Post-intervention Questionnaire

CONCEPT	CONCEPTION	FREQUENCY
Rotation and Revolution	a) Earth's spinning motion is rotation.	17
	b) Earth revolving around Sun is called rotation.	09
	c) Earth revolving around Moon is called rotation.	0
Relative motion of the Sun, Moon and Earth	a) The Moon and Sun revolve around Earth in the same orbit.	0
	b) The Sun and Moon revolve around Earth in concentric orbits.	03
	c) Sun and Moon orbit around Earth, with Sun on the left and Moon on right.	0
	d) Earth orbits around Sun and Moon orbits around Earth.	23
Characteristics of Moon	a) Moon stores light and releases it at night.	0
	b) Moon gives away light from Sun.	21
	c) Moon gives away light from Earth.	05

Table 2 depicts the change in learners' conceptions in the post-intervention questionnaire. Sixty-five per cent of the learners correctly identified Earth's rotating motion and distinguished it from Earth's revolution around Sun but 35 per cent of the learners still had confusion in distinguishing between the two types of motion (rotation and revolution) of Earth. For the relative movement and positioning of the Sun, Earth and Moon, 88 per cent of the learners selected the right model and also illustrated it diagrammatically. 12 per cent of the learners that is, 3 learners chose the model in which Sun and Moon both revolved around Earth, but they did understand that Moon is closer

to Earth than the Sun. With respect to the characteristic properties of Moon that is, it shines or not, 80 per cent of the learners answered that Moon doesn't have light of its own.

Cause of Day and Night

Learners' naïve ideas revealed a geocentric model of the universe, that is, everything revolves around Earth be it Sun or Moon. While 5 learners believed that Sun goes around Earth during the day and the Moon revolves around Earth during the night, 6 of them believed that Sun and Moon come up in the sky and go down behind the mountains at their respective time, thus, indicating Earth-based observations.

Table 3: Frequency of Learners' Preconceptions with regard to the Cause of Day and Night

Preconception	Frequency
Sun orbits around Earth in day and moon orbits at night	5
Sun is at the right-hand side of Earth, and Moon is at the left. Earth spins in between	8
Sun comes out from hiding and sets again behind the mountains at 6 in the evening	6
Sun and moon orbits along the same path around Earth, but remain on opposite ends. When it's daytime in India, it's night in America.	4
Earth orbits around Sun in the day and around Moon at night	3

When asked about the distance of Sun and Moon from Earth, learners believed that Sun and Moon are in the sky with nearly no distance among the three celestial bodies. Eight learners were of the view that Earth spins between stationary Sun on the right-hand side and Moon on the left or vice-versa. So, when Earth faces Sun, it is day and when it faces Moon, it is night. It is interesting to note that learners associated Moon with night and nobody shared any observation of seeing Moon in the daytime

as well. Four learners believed that Sun and Moon revolve around the Earth in the same orbit causing day in the part exposed to Sun and night in the other part (where Moon is present). Moreover, 3 out of 26 learners believed they see Sun during the day and Moon at night as result of Earth’s revolution around sun during the day and around the moon at night. The children were found to be using the concepts of rotation and revolution interchangeably as per their convenience without recognising the difference between the two.

The use of models and storytelling sessions conducted as part of the intervention helped the learners in predicting what part of the globe would have a day and which part would have a night. Learners were also able to understand that one complete rotation of Earth makes it one complete day for us, using the globe and torch light that is, 24 learners out of 26 were able to grasp the concept using both these stories.

The following graph compares 25 students’ (one learner was on leave) representations of the cause of day and night before and after the intervention.

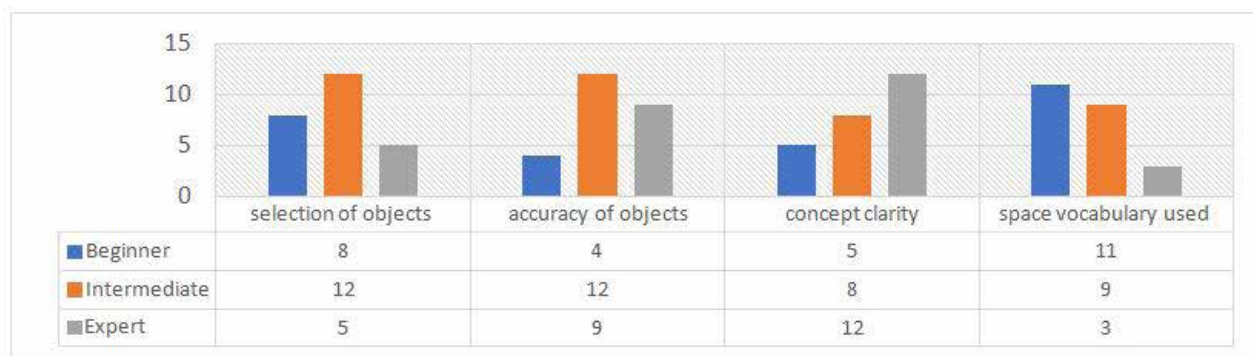

Rubric 3 Concept of day and night using models

Rubric 3 gives an overview of learners’ progress in the understanding of the concept of day and night. It was observed that 32 per cent of the learners used random objects like eraser, scale, notebooks to represent the celestial bodies and hence, were categorised to be at the beginner stage. Forty-eight per cent were at the intermediate level as they chose the same objects as were used in the story. Twenty per cent of the learners were in the advanced stage as they chose objects, which could rightly substitute the objects used in the story (balls of different sizes, and material). Forty-eight per cent of the learners clearly explained the cause of day and night on Earth using their models. The following discussion took place during a storytelling session of *The Story of Time*:

Learner 17: पर पहले के लोगों को नहीं पता चलता होगा ना टाइम का, घड़ी तो थी नहीं उनके पास

The teacher helped them recall how people in the story used to determine what time

of day it was. The learners were amazed at how shadows could be used to predict time. They further explored the idea and made the observations mentioned below.

Learner 17: तो जब सूरज बिल्कुल हमारे ऊपर होता है तो परछाई ज़मीन के नीचे बनती है?

सूरज, बिल्कुल ऊपर वाली परछाई कहां बनती?

Simultaneously, the teacher demonstrated an activity of shadow formation using a pin and torch light.

Learner14: मैंने देखा है शाम को लंबी-लंबी परछाई बनती है |

Learner14 predicted: अब आदि - मानव को पता चल गया ना कि 5:00, 6:00, 7:00 व

8:00 बजे कितनी लंबी परछाई बनती है |

As evident from the responses, the learners understood the difference in the size of shadows with respect to Sun’s position observable in the sky and shared their observations. One of the learners made

an interesting remark regarding Sun being stationary.

Learner 6: पर मैम सूरज थोड़ी ना ऊपर नीचे होता है, हम होते हैं ना |

Learner 7: हम नहीं होते पृथ्वी होती है |

Learner 17: पृथ्वी भी नहीं होती, पृथ्वी घूमती है |

Learner 2: रोज सुबह 5 बजे सूरज निकल आता है |

Learner 17: नहीं, कभी देर से भी आता है |

Learner 2: वो सर्दी में आता है, 7 बजे तक |

Thus, the learners tried to predict the relationship between the position of Sun in the sky during various seasons and its relation to time.

The storytelling session resulted in the learners sharing their own stories and analogies.

Learner 4: पृथ्वी कैसे घूमती है ना जैसे बॉल घूमती है; बॉल तो रुक भी जाती है पृथ्वी रुकती है क्या?

Learner 16: ऐसा होगा तो हमेशा ही धूप या हमेशा ही रात रहेगी ना फिर?

Table 4. Frequency of Learners' Conceptions in the Post-intervention Questionnaire

Concept	Conception	Frequency
Cause of day and night	a) Earth's revolution around Sun.	7
	b) Sun and Moon revolve around Earth; the part exposed to Sun experiences day.	1
	c) Sun and Moon go up and down in the sky.	0
	d) Earth's rotation, the part facing Sun experiences day.	18

The above table shows the result of the post-intervention questionnaire. It was found that 69 per cent of learners selected the correct answer for the cause of day and night on the Earth, while 27 per cent of learners selected the picture of Earth's revolution as the cause for the phenomena. Also, 100 per

cent learners responded that a day consists of 24 hours.

Phases of Moon

Learners' preconceptions (Table 5) showed that 11 learners out of 26 felt that Moon originally has a crescent shape whereas remaining 15 learners believed it to be a sphere. Out of those 11 learners, 3 held the perception that Moon is originally a crescent and stars join in to form a full moon gradually day by day. But sometimes Moon breaks into pieces and gets restored to its original crescent shape. Eight learners believed that just as plants grow, die and grow again, Moon grows each night, then gradually dies and then grows again the next night.

Table 5. Frequency of Learners' Preconception on the Phases of Moon

Preconception	Frequency
Clouds hide Moon.	7
Smog in winter hides Moon.	1
Stars join in a crescent Moon to form full Moon.	3
Moon grows in size as the night falls.	8
Moon comes out in full phase and reduces in size gradually, completely disappearing in the morning.	5
Earth's shadow causes different phases.	2

Out of 15 learners, one learner's views were guided by the contemporary socio-scientific issue of increasing pollution in the city. He reasoned that we are not able to see a full moon phase during winter season as smog covers Moon in winter. Five learners were of the view that Moon comes out each night in a full phase but as the night grows, it reduces in size and disappears completely in the morning when it is time for Sun to come out. Two of the learners reasoned that it is because Earth casts a shadow on Moon due to the light coming from Sun that we see

different shapes of Moon each day but the Moon is actually a sphere.

The picture book used to show the various phases of Moon helped the learners recall their own observations and cultural knowledge related to it.

Learner 17: होली अमावस वाले दिन मनाते हैं ना ?

Learner 8: और Ma'am, दिवाली वाले दिन चांद नहीं निकलता तभी हम दिए जलाते हैं |

Learner 22: क़रवा चौथ वाले दिन भी पूरा चांद निकलता है |

Learner 12: एक और ब्रत होता है जो मम्मी हमारे लिए रखती हैं वह भी चांद को देखकर ही तोड़ते हैं |

Out of 25 learners, 17 were able to make predictions about what Moon would look like next in the story. They counted the number of times it appeared to change in the book and reached to the concept of relating its phases with a month. Sixteen learners shared their experiences with different phases of Moon visible to them on various festivals.

The next storytelling session was planned to cater to these curiosities. An adapted version of the song by StoryBots' 'Time to Shine' was used to address learners' naïve conceptions. Learners' understanding was assessed using role-play activity planned for them in groups of three.

Their progress was recorded using Rubric 4 and the result of 26 learners is represented in Table 6. It is observed that 38 per cent of the learners were correctly able to depict the movement of all the three celestial bodies and 46 per cent were able to present with at least 2 objects correctly in place. 65 per cent of the learners were able to explain the cause, whereas, 76 per cent were able to depict the phases of moon with or without the help of their friends. Around 81 per cent of the learners were able to depict a specified phase of the Moon given by the teacher, with or without the help of their friends.

Table 6. Learners' Understanding of the Phases of Moon in the Post-intervention Questionnaire

Concept	Conception	Frequency
Shape of Moon	a) crescent	4
	b) spherical	22
	c) semi-sphere	0
	d) any other	0
Cause of the Phases of Moon	a) Clouds cover the Moon	5
	b) It dies and gets born every next day	0
	c) We only see the part on which Sun reflects light and is visible because of the relative positioning of Sun, Earth and Moon.	21

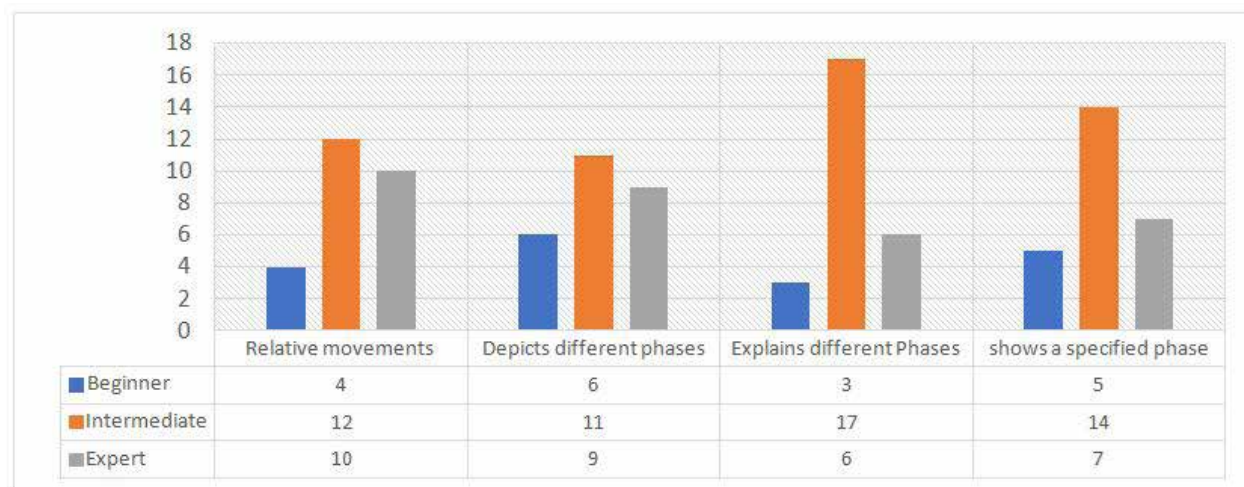

Rubric 4. Understanding of phases of moon through role-play

Spec- ified Phase of Moon	a) Knows what the Full Moon phase looks like (and is acquainted with the space vocabulary)	26
	b) Does not know the Full Moon phase	0

The post-intervention responses revealed that 94 per cent of the learners selected the correct shape of the Moon, while 6 per cent still selected the crescent shape. Regarding the cause of different phases of Moon observable to us, 80 per cent of the learners could correctly answer the question while 20 per cent still believed that we see Moon differently each night due to the clouds hiding some or the other part of it. All the learners could predict the correct phase of Moon.

Conclusion

This study provides insights into learners' ideas regarding the relative movement of the Sun, Earth and Moon and the related phenomena. Learners' preconceptions were

majorly shaped by various mythological stories and children's literature that they were exposed to. Hence, Sun, Moon and Earth majorly had a face in their diagrammatic representations as these were not celestial objects but God-like figures or objects. It was found that the learners possessed a great deal of narratives which were significantly different from the scientifically accepted conceptions. The study illustrated that selection of appropriate stories in the classroom can help the learners make a transition from their pre-causal thinking to acceptance of the scientifically correct conceptions. Storytelling, as a pedagogical strategy for the explanation of scientific concepts, was effective in nurturing learners' curiosity and provided opportunities to engage learners in making predictions, questioning and reasoning. The results of this study provide interesting insights into children's thinking and would be useful in planning a curriculum on astronomy for the primary grade learners in India. Further, it highlights the importance of storytelling as a pedagogical tool for teaching astronomy.

References

- AUSUBEL, D. P. 1968. Facilitating Meaningful Verbal Learning in the Classroom. *The Arithmetic Teacher*. Vol. 15, No. (2). pp. 126–132.
- BANISTER, F. AND C. RYAN. 2001. Developing Science Concepts through Storytelling. *School Science Review*. 82, . pp. 75–84.
- BERRY, N. 2002. *The Story of Time*. Children's Book Trust, India.
- BRUN, M. 2017. *The Day I Met My Shadow*.
- JOUBERT, M., D. LLOYD AND J. METCALFE. 2019. Storytelling: The Soul of Science Communication. *Stories in Science Communication*. JCOM, 1,2.
- MORGAN, S. AND R. F. DENNEHY. 1997. The Power of Organizational Storytelling: A Management Development Perspective. *Journal of Management Development*.
- NATIONAL COUNCIL OF EDUCATIONAL RESEARCH AND TRAINING. 2005. *National Curriculum Framework 2005*. National Council of Educational Research and Training, New Delhi.
- Netflix Junior. StoryBots. 2013. Time to Shine. Retrieved from: <https://www.youtube.com/watch?v=i235Y2HRks>
- PINTRICH, P. R., R. W. MARX AND R. A. BOYLE. 1993. Beyond Cold Conceptual Change: The Role of Motivational Beliefs and Classroom Contextual Factors in the Process of Conceptual Change. *Review of Educational Research*. Vol. 63, No. 2. pp. 167–199.
- PLUMMER, J. D. 2009. Early Elementary Students' Development of Astronomy Concepts in the Planetarium. *Journal of Research in Science Teaching: The Official Journal of the National Association for Research in Science Teaching*. Vol. 46, No. 2. pp. 192–209.

- RAO, S. AND T. MARUDU. 2019. देखो चांद. Tulika Publishers.
- SHULMAN, L. S. 1986. Those Who Understand: Knowledge Growth in Teaching. *Educational Researcher*. Vol. 15, No. 2. pp. 4–14.
- VOSNIADOU, S., C. IOANNIDES, A. DIMITRAKOPOULOU AND E. PAPADEMETRIOU. 2001. Designing Learning Environments to Promote Conceptual Change in Science. *Learning and Instruction*. Vol. 11, No. 4–5. pp. 381–419.



Perception of Prospective Teachers towards Four-Year Integrated Teacher Education Programme

Abstract

Despite having the importance of 21st century skills (OECD, 2018), therefore, global perspective-oriented training of prospective teachers has been a decisive issue not only in India but overseas also. Ergo, the paradigm of teacher training in India has recently been shifted to integrated model (blending between content, pedagogy and technology) of teacher education followed by different models like horizontal integration (B.A. B.Ed. & B.Sc. B.Ed.) and vertical integration (M.A. B.Ed. & M.Sc. B.Ed.) for preparing committed, responsible and professional teachers to fulfil the needs and aspirations of the society and nation (NCTE, 2014). But nowadays it has become a debatable issue for ascertaining the effectiveness of the integrated model of teacher education programme to produce the best professionals. Therefore, this study has been focused to assess the perception of prospective teachers towards the Four-year Integrated Teacher Education Programme (ITEP). In the study, 93 prospective teachers of final year of four-year ITEP (B.A. B.Ed. - 48 & B.Sc. B.Ed. - 45) were selected through purposive sampling technique. The investigator used self-made tool for data collection. Qualitative analysis was used to analyse the data. The results reveal that prospective teachers' perceptions towards ITEP are favourable to prepare professionals in the teaching profession by adopting the Technological Pedagogical Content Knowledge (TPCK) framework; helpful to qualify the necessary exams like CTET and STET. But some critical points are needed to rethink the reforms in the structure of ITEP, like bridging the gap between undergraduate and postgraduate level teacher education programmes, to reduce the credits load, coordination between liberal and education departments and true integration between theory, practice and technology. The findings of the study are expected to encourage the scholarly attention and critical reflections on the effects of different models on the professional competencies of prospective teachers. Possible educational implications and policy outcomes are outlined.

Keywords: Prospective Teacher, Perception, Four Year Integrated Teacher Education Programme,

“A teacher can never truly teach unless he is still learning himself. A lamp can never light another lamp unless it continues to burn its own flame.”

- Rabindranath Tagore

Introduction

Teachers are considered to be the nation builder and backbone of any country (Kalam, 2006); they are the social engineers who transform the society by socializing and humanising our young minds (Sudalaimuthu, 2013). Furthermore, the responsibility of a teacher in shaping the future of the nation is clearly mentioned by The Education Commission (1964–66) by stating that “The Destiny of India is now being shaped

in her classrooms.” The National Policy on Education NPE (1986) underlines this greater role as elucidated here: “The status of the teacher reflects the socio-cultural ethos of the society. It is said that no people can rise above the level of its teachers.” However, various commissions and committees have been set up for providing direction for the improvement of teacher education across the country. But NCFTE (2009) highlighted that the present teacher education scenario has seen an extraordinary expansion of teacher

education institutions and programmes to meet the increasing demand for teachers. As a result, there has been a large increase in the number of B.Ed. colleges and a virtual mushrooming of teacher education institutions (Bharati, 2019). Ergo, to train individuals to become an effective teacher is a critical issue from so many years. The changes in economic, political, social and technological spheres have deeply influenced the nature, structure and functions of teacher education throughout the world. In the light of the report *Learning without Burden (1993)*, the National Curriculum Framework for School Education (NCFSE-2005) highlighted the five guiding principles: (i) connecting knowledge to life outside the school; (ii) ensuring that learning shifts away from rote methods; (iii) enriching the curriculum so that it goes beyond textbooks; (iv) making examinations more flexible and integrating them with classroom life; and (v) nurturing an overriding identity informed by caring concerns within the democratic polity of the country (NCF, 2005). For ensuring quality teacher education, the curriculum framework of teacher education was developed by NCTE (2009) which highlighted the dimension of the curriculum practices for prospective teachers to develop professionalism at different stages of the school system and increased the duration of each programme (Sahoo & Sharma, 2018). The Justice Verma Commission (2012) report has also given specific recommendations in the form of restructuring of pre-service and in-service teacher education throughout the country. Before the half century, a paradigm shift was brought about in teacher education in the form of a four-year teacher education programme. The National Commission on Teachers (1983-85) recommended five-year integrated courses with internships. However, it was firstly started in Regional Colleges of Education of NCERT, thereafter, Kurukshetra University, Rural institute in Vidya Nagar. However, in the first phase it was designed for science, mathematics and technology.

In addition, recently NCTE has recommended two models of teacher education programmes—the Integrated Teacher Education Programme after 10+2 (content-cum-methodology) and the Non-Integrated Teacher Education Programme after 10+2+3 (content free). Thereafter, NCTE proposed a four-year ITEP for Class XII students with 50 per cent marks as realised to be necessary for preparing committed, responsible and professional teachers. The curriculum of the integrated programme is designed to inculcate the world's best practices in the field of teacher education. Students in Integrated Programme learn courses with the integration of theory, practice and technology. It also visualises the vertical mobility of teachers. After completing the Integrated Programme, the students are free to take up a master's degree Programme (Content) or master's degree Programme in Education (M.Ed.), or can choose the teaching profession. In this programme, a student can complete graduation in content and methodology both in four year whereas in the Non-Integrated Programme (two-year B.Ed.), a student spends 5 years to reach the same level. This programme emphasises more on the most desirable blending of content, pedagogy and technology. This combination is called the Technological Pedagogical Content Knowledge (TPACK) framework. It provides the opportunity to shape young minds and motivate them to choose the teaching profession as a career. Although teacher education programme has considerable benefits, but it faces some challenges too:

- (i) After completing the programme, it is unclear where students will go either PG programme in parent discipline or education discipline, therefore, integration will break down.
- (ii) Which model is more effective for teachers' preparation—the integrated or non-integrated programme?
- (iii) Ensuring the sharing of existing physical resources of the other departments of the University/ Colleges /Composite teacher education institutions

- (iv) ITEP is not merely a combination of two courses but the complete interweaving of courses with respect to content, pedagogy and technology. For the effective use of TPACK framework and requires the same coordination in the teaching faculty for the core disciplines and the teacher education department.

Review of Related Researches

The evidence of research studies conducted in India regarding the reforms of structure of teacher education is available in ample account. Prospective teachers are the pivotal point of the different models of teacher education programme, therefore, the prospective teachers' perception towards ITEP is considered as a significant aspect in this respect. However, some studies have already been conducted in India in the field of teacher education. Bhattacharjee (2002) reported that students in the one-year B.Ed. programme were found to be better in their attitude towards teaching and scientific aptitude than students in the four-year B.Ed. programme. In contrast, Moruskar (2004) found that students enrolled in the four-year integrated B.A. B.Ed. are better than one-year B.Ed. students with respect to teaching competency and teaching effectiveness. Tamang (2018) conducted a study on the attitude of teacher educators towards implementation of two years teacher education and reported that two-year B.Ed. course is better than one-year B.Ed. course in case of quality education and quality of teacher preparation. Sushma (2016) found no significant difference in the attitude of government, aided and unaided teacher educators' attitude towards the two-year B.Ed. programme. Nataraja (2016) reported that that two-year B.Ed. programme was not favourable. However, they realised its importance for enhancing the prospective teachers' competencies with a two-year programme. Adhikary (2017) found a mixed perception towards the two-year B.Ed. programme in Assam and reported dissatisfaction towards

the curriculum distribution of the two-year B.Ed. programme. The results of the present study revealed that the majority of teachers working in the elementary school as well as the prospective ones had less or unfavourable attitude towards the teaching profession. They recommended the induction of those teachers who had a positive and more favourable attitude towards teaching profession (Farrukh & Shakoor, 2018). In contrast, Sahoo & Sharma (2018) reported that the curriculum reform in teacher education was appreciated by student teachers. The structure reform in teacher education introduced by NCTE need not be associated with the needs and aspirations of the society and the nation alone but also with student teachers, teachers and teacher educators.

After an analysis of the reviews, however, it was found that a number of studies are conducted to study the perception and attitudes of prospective teachers and teachers towards two years B.Ed. Programme and four-year ITEP as offered by RIEs of NCERT. But there seems to be a dearth of studies on the perception of prospective teachers towards the four-year ITEP as offered by other institutions than RIEs. Ergo, to fill this gap, the present study has been conducted to study the perception of prospective teachers towards a four-year Integrated Programme in Teacher Education.

Objective of the study

The objective of present study is as follows: To study the perception of prospective teachers towards the four-year Integrated Teacher Education Programme

Methods and Procedures of the Study

A descriptive survey method was used to conduct the study primarily sought to describe and understand the perception of prospective teachers towards the four-year ITEP.

For the present study, the population selected all the prospective teachers in the last semester of the four-year integrated B.A. B.Ed. and B.Sc. B.Ed. programmes from Central University of South Bihar (CUSB), Gaya. This study comprised 93 students of B.A. B.Ed. (48) and B.Sc. B.Ed. (45), who were selected purposively. Only the prospective teachers of CUSB, Gaya are included in the present study. The

investigator used a self-made tool consisting of two parts for data collection of the study. In the first part, a three-point Likert scale having the responses—Agree (A), Neutral (N), and Disagree (D) was used, and in the second part, open-ended questions were used. It was validated by the experts' views of teachers, teacher educators and psychologists. Thereafter, data was analysed both quantitatively and qualitatively.

Analysis Of Data

The analysis and interpretation of the study have been presented in Table 1.

Table 1

Part-I				
S. No.	Statement	Response (%)		
		Agree	Neu-tral	Disagree
1.	The vision of ITEP is relevant for improving the quality of teacher education in India.	79.70	8.10	12.16
2.	ITEP helps to prepare the competent professionals for the demands of the teaching profession.	78.08	13.69	8.21
3.	ITEP is the true blending among content, pedagogy and technology.	54.66	26.66	18.66
4.	Institutions provide the following adequate resources for the proper teacher training:			
	i. Academic Calendar	81.17	9.21	9.21
	ii. Timetable	81.08	8.10	10.81
	iii. Exam calendar	78.37	10.81	10.81
	iv. Lab facilities	62.16	13.15	24.32
	v. Smart Board Room	71.40	11.68	16.88
	vi. ICT lab	59.72	8.33	31.94
	vii. Lab (Language, Math, Science and Social Science).	54.05	18.91	27.02
	viii. Facility of library	64.00	10.66	25.33
	ix. Specialised faculty members	62.16	10.81	27.02
5.	ITEP curriculum is burdensome to some extent for prospective teachers.	62.66	17.33	20.00
6.	ITEP emphasises the following components in T-L process:			
	i. Allotment of course instructors according to their specialisations	58.10	16.21	25.67
	ii. Learner centered activities	45.94	16.21	37.83
	iii. Use of effective methods in teaching (problem-solving, project, inductive-deductive, etc.)	57.89	15.78	26.31
	iv. Continuous and comprehensive assessment	80.62	6.84	12.32

	v. Proper Weightage to practice teaching (SIP)	71.23	13.69	15.06
	vi. Proper feedback system	60.81	12.16	97.02
	vii. Conduction of workshops/seminar	48.52	19.11	32.35
	viii. Information and guidance for competitive Exams	37.66	10.38	51.94
	ix. Proper orientation & opportunities for placement	43.05	5.50	51.38
	x. Facility of Guidance and Counselling	50.00	10.81	39.18
7.	ITEP provides adequate time for:			
	i. Completing the course of liberal discipline	44.44	19.44	36.11
	ii. Completing the course of education discipline	61.64	13.69	24.65
	iii. Micro-teaching	65.75	16.43	17.80
	iv. Completing the school internship	71.62	10.81	17.56
	v. Co-curricular activities	46.57	20.54	32.87
	vi. Library	50.00	16.21	33.78
	vii. Computer laboratory	43.83	19.17	36.98
	viii. Self study	43.05	20.83	36.11
	ix. Discussion (teachers/students etc.)	50.70	22.53	26.76
	x. Completing the curriculum	57.53	21.91	20.50
	xi. Completing the assessment procedure	52.77	19.44	27.77
	xii. For remedial teaching	42.85	14.28	42.85
	xiii. Preparation for the higher education	43.05	6.94	50.00
8.	ITEP provides the opportunity for collaboration, coordination of different departments for preparing the competent teachers.	53.33	22.66	24.00
9.	In the institution, all concerned departments/schools are well coordinated to achieve the goal of ITEP.	44.44	16.67	38.89
10.	ITEP is helpful to achieve the targets after/during the programme like (regarding qualified the exams like CTET, STET and other related exams from the teaching profession)	70.83	15.27	13.88
11..	ITEP provides the better opportunities for better employment in teaching profession	56.94	20.83	22.22
12.	ITEP fulfils your requirements considering the required characteristics of true professional in the teaching profession	54.05	22.97	22.97
13.	Two-year B. Ed. is better than ITEP because it provides proper time and it is less burdensome.	28.37	17.56	54.05

Part-II

1. What do you mean by Integrated Programme in Teacher Education or Integrated Teacher Education Programme?
2. ITEP truly integrates the contents of the liberal discipline (science/social science course) and education discipline. If not, why?
3. ITEP is the true blending between content, pedagogy and technology.
If not, why?
4. Which one model of the Integrated Programme in Teacher Education do you prefer for preparing teachers?
 - i. Horizontal Integration in the Teacher Education Programme (B.A. B.Ed./B.Sc. B.Ed.)
 - ii. Vertical integration in the Teacher Education Programme (M.A. B.Ed./M.Sc. B.Ed.)
 If yes, why?
5. Mention, which part of your programme (B.A. B.Ed./B.Sc. B.Ed.) do you like the most?
6. After completing your programme, which one of the following programmes will you prefer?
 - i. PG programme (M.A./M.Sc.)
 - ii. PG programme (M.Ed.)
 - iii. M.A. M.Ed./M.Sc. M.Ed. Programme (New Model for continuing the integration between B.Ed. and M.Ed.)
7. What major problems you've faced during the completion of this programme?
8. As a part of this Programme, what suggestions you want to provide for the improvement of this programme.

Major Findings

After analysing data, the following major findings were reached:

1. 90 per cent of the prospective teachers prefer ITEP rather than two-year programmes because this provides opportunities for saving the year with dual degree and also provides a backup for their career at an early stage.
2. However, most of the prospective teachers are satisfied with the effort to establish a blending between content and pedagogy but not technology. It may either be due to the non-availability of proper resources or absence of trained teachers for the course—ICT in Education.
3. 50 per cent of the prospective teachers realised that true integration is not present between the parent departments and teacher education department. That is why content and pedagogy are being taught simultaneously but true integration is missing.
4. However, 75 per cent of the students want to do a post graduate programme in their parent discipline. Only 16 per cent students have shown their willingness to choose an innovative programme such as MA M.Ed./M.Sc. M.Ed., if they get the opportunity. But unfortunately, only 4 per cent students are willing to take admission in the M.Ed. programme after the completion of ITEP. Besides that, no student from the science stream showed his/her interest to take admission in the M.Ed. programme.
5. Most of the prospective teachers are dissatisfied with the course structure especially due to burdensome courses of education components.
6. 90 per cent of the prospective teachers experienced that this programme does not provide the time for discussion, self-study with reference books and especially for preparation of higher education. Therefore they want to reduce the credits of the education component and shift SIP from the last semester to the sixth and seventh semesters. Hence, in semester VIII, they will get time for the preparation of competitive exams for higher education and jobs too.

7. Most of the prospective teachers realised that equal focus is not given to the liberal discipline and education component. The contents of B.A. and B.Sc. are not properly dealt with when compared to B.A. and B.Sc. Honours. That is why they face difficulties to get admission in P.G. programmes in renowned higher educational institutions.
8. 90 per cent prospective teachers supported horizontal integration in the field of teacher education rather than vertical integration.

Conclusion

The study revealed that there was a favourable perception of prospective teachers towards the ITEP with respect to producing competent teachers as demanded in the teaching profession, best blending between content and pedagogy, effective teaching-learning process, helpful in qualifying various teacher eligibility tests like CTET, TET and other related exams in the teaching profession. But some points are very critical to think again like introducing an innovative model, reducing credits especially from the education component by removing the repetition of course content, full time school internship in reputed schools and scheduled in the sixth and seventh semesters, coordination between the liberal and education disciplines, and an equal focus on both disciplines. On the basis of the above findings, some suggestions are made to create a positive perception among the prospective teachers so that the desired goal of the teacher preparation model as prescribed by NCTE can be achieved.

1. The first and foremost vision of ITEP is to attract young aspiring minds in the teaching profession for a better education system across the country but unfortunately, students still consider this programme as a back-up option for their career and as a means to save an year in their degree. Therefore, again this objective seems to not be catered. Hence, we have to think in this direction.
2. As per the findings, only 4 per cent students are willing to pursue the PG programme in Education (M.Ed.) whereas no student of science stream is willing to do this. Therefore, for continuing the integration, NCTE should rethink an innovative model, that is, M.A. M.Ed./M. Sc. M.Ed. after B.A. B.Ed. and B.Sc. B.Ed. for preparing better teacher educators.
3. Due to frequent and drastic changes in the structure of the teacher education programme, especially the duration of the programme, different models and eligibility of teacher educators, it creates confusion and discourages students to opt the teacher education programme at the postgraduate level. Hence, NCTE should rethink in this direction too.
4. Provision of school internship in the last semesters of the programme without any theoretical burden.
5. As per the findings, 90 per cent of the prospective teachers felt that this programme was very burdensome and not giving equal weightage to the liberal disciplines. Therefore, credits should be reduced especially from the education discipline by removing repetitive contents and making it more practical rather than theoretical.
6. Students also observed that there is a lack of collaboration between liberal and education departments as it should be in composite institutions (NCTE, 2014). So, the regulatory bodies and authorities should think about this too.

After analysing the findings and reviews of related researches, the prospective teachers gave a highly positive opinion regarding the use of student-centric methods, assessment, orientation and practices of school internship. In addition, they liked the provision for the assessment of institutions by NAAC and other assessment agencies through a transparent procedure. Ninety per cent prospective teachers preferred integrated teacher education programmes rather than the two-year programme because they wanted to

save one year for getting the dual degree. As a whole, the teacher education students have expressed a positive opinion about the structural reforms in teacher education introduced as per NCTE regulation in 2014. But some critical points were outlined such as the absence of true coordination between the liberal and education departments, not giving equal weightage to the liberal disciplines, lack of appropriate use of ICT in T-L process, a burdensome programme that limits the time for self-learning, discussion and use of libraries too. Such perceptions of prospective teachers have significant implications in strengthening teacher education programmes in the teacher

education institutions across the country. However, it is not clear yet why the policy has been restricted only to run ITEP than sequential teacher education programme (Bharti, 2019). But the discussion about the existence of one-year training programme after PG and two year after UG programme ,etc., are being done in the draft of the New Education Policy (2019, p.--). Finally, there is a great need to conduct qualitative researches for assessing effectiveness of the integrated and non-integrated model of teacher education programme in reference to professional competencies (including TPACK framework) and attitudes towards the teaching profession of prospective teachers.

References

- ADHIKARY, A. 2017. A Study on the Perception of the Prospective Teachers Towards Two-year B.Ed. Programme Implemented in the Teacher Education Institutions in Assam. *International Journal of Scientific and Research Publications*. Vol. 7, No. 9. pp. 385.
- BHARTI, G. 2019. Four Year Integrated Teacher Education Programme (ITEP): Issues & Concerns. *Voice of Teachers and Teacher Educators*. Vol. 8, No. 2. pp. 19–23.
- BHATTACHARJEE, D.K. 2002. *A Comparative Study of Four-year Integrated B.Sc. B.Ed. Students and One-year B.Ed. Students (Science) with Regard to Attitude to Teaching Profession, Aptitude for Teaching, Personality Traits, Professional Competence and Commitment/ Dedication to Teaching Profession*. Research project, NCERT.
- FARRUKH, I. A. AND U. SHAKOOR. 2018. A Comparative Study of the Attitude of the Male and Female Elementary School Teachers Towards Teaching Profession. *Journal of Education and Educational Development*. Vol. 5, No. 2. pp. 227–239.
- GOVERNMENT OF INDIA. 1983. Report of the National Commission on Teacher-I, The Teacher and Society, Chattopadhyaya Committee Report. Ministry of Education, New Delhi.
- . 1993. *Learning without Burden: Report of the National Advisory Committee*. Ministry of Human Resource and Development, New Delhi.
- . 2012. *Justice Verma Committee Report*. Government of India, New Delhi.
- KALAM, A.P.J.A. 2006. *Indomitable Spirit*. Rajpal & Sons, New Delhi.
- MINISTRY OF EDUCATION. 1966. *The Education Commission: 1964–1966*. Ministry of Human Resource and Development, New Delhi.
- . 1986. *National Policy on Education-1986*. Ministry of Human Resource and Development, New Delhi.
- Ministry of Human Resource and Development. 2019. Draft of *National Policy on Education-2019*. Retrieved from <http://www.nuepa.org/new/download/NEP2016/ReportNEP.pdf>
- MORUSKAR, D.S. 2004. *A Comparative Study of the Teachers Trained through Four-year Integrated Course and One-year Course in Secondary Teacher Education in Respect of Teacher Competency and Teaching Effectiveness*. Retrieved from <http://hdl.handle.net/10603/140149>
- NATARAJA, R. 2016. Attitude of Prospective Teachers towards Two-year B.Ed. Programme and their Future. *Scholarly Research Journal for Humanity Science and English Language*. Vol. 3, No. 25. pp. 3646–3649.

- NATIONAL COUNCIL OF EDUCATIONAL RESEARCH AND TRAINING. 2005. *National Curriculum Framework for School Education-2005*. NCERT, New Delhi.
- NCTE. 2009. *National Curriculum Framework for Teacher Education: Towards Preparing Professional and Humane Teacher*. NCTE, New Delhi.
- . 2014. *Norms and Guidelines for Teacher Education*. NCTE, New Delhi.
- OECD. 2018. *Social and Emotional Skills for Student Success and Well-being: Conceptual Framework for the OECD Study on Social and Emotional Skills*. OECD, Paris.
- SAHOO, P.K. AND P. SHARMA. 2018. Student Teachers' Perception towards the Restructuring of Teacher Education Programmes. *Educational Quest: An International Journal of Education and Applied Social Science*. Vol. 9, No. 2. pp. 187-201.
- Sudalaimuthu, S. 2013. Teachers are Social Engineers. *The Hindu*. Retrieved from <http://www.thehindu.com/todays-paper/tp-national/tp-tamilnadu/teachers-are-social-engineers-says-vicechancellor/article4659481.ece>
- SUSHMA, R. 2016. Attitude of Teacher Educators' towards Two-year B.Ed. Programme. *Scholarly Research Journal for Humanity Science and English Language*. 3, 3365-3370.
- TAMANG, P. 2018. Factors Impacting Attitude of Teacher Educators towards Two-year B.Ed. Programme in Select Colleges of West Bengal. Doctoral dissertation. Sikkim University,
- THE GAZETTE OF INDIA. 2009. *The Right of Children to Free and Compulsory Education Act, 2009*. New Delhi.

Anirban Roy (Doctoral Scholar (JRF))

anirbanroy247@gmail.com

Sushmita Singh

sush.audi2k13@gmail.com

Investigating the Learning Gaps of Senior-secondary Children through Original (Real-life) Biological Images: What Really Lacks?

Abstract

The dismal learning levels of students in our school(s) posit a putative question on the institutional failure of the Nation's education system. But this comes as no surprise, given the prevailing priorities of our education system lie only with rote memorization and good score(s) in the examinations. In pursuit of finishing the syllabus within a stipulated time, teachers often completely ignore the "learning gaps" being imbibed by the child. One of the more consequential features of learning gaps is their tendency, if left unaddressed, to compound over time and become more severe and pronounced, which can increase the chances that a student will struggle academically and socially or even drop out of school. Given diagrams as an imperative tool in the assessment process of learning gaps, senior secondary level Class XII students were given a picture-based questionnaire containing 16 original (real-life) images of biological entities and events; each of the images (microscopic and macroscopic) was followed by blank spaces for identification and labelling. The students were asked to identify the coloured images and write their responses. The student's responses highlighted the gaps and errors regarding the concerned topics that have formed over the years. It was followed by an open-ended interview to perceive the latent stimulus that drove the responses of the students for the images. The students' responses revealed some pioneering observations that subtly unveil the need for inclusion of the original (real-life) images in the science textbooks, in addition to the textbook images. Keywords: Learning gaps, Original (Real-Life), Picture-based Questionnaire, Textbook Images

Introduction

"Mind the gap" is a frequently encountered visual warning phrase in the Indian metro railways that presages the passengers to carefully board the train to avoid any contretemps. The phrase has been employed to warn the travellers to avoid the gap between the train floor and the platform as they board or set off the train, thus, referring to the perils a gap can cause if unaddressed. In a similar genre, the authors tend to relate this phrase in association with the teaching-learning transactions of our schools where the students become victims of gaps in learning.

Fink (2003) has reflected upon one strategy for improving learning amongst students by integrating the new knowledge with the prior experience of the students. Teachers are responsible for guiding students to collate the old and new knowledge and facilitate them to analyse and synthesise at higher levels (Bloom, 1956). Learning and its proper transmittance have always been the centre of debate for many educational psychologists. There is a distinction between meaningful and rote learning as stressed by Ausubel et al. (1978) who believed that the former refers to the reflection of personal understanding of what is being taught, while the latter denotes forced inputs of concepts into the memory to perform well in the

assessment. Quoting O'Brien (2008) from her thesis (pp. 156–157), "That is, subject matter that is construed, constructed and presented in instrumentalist, technical terms will facilitate largely instrumentalist, technically-oriented outcomes, effective for the mastery of key skills and competencies. In contrast, learning that requires the development of higher forms of knowledge and knowing, entailing a transformation of perspective and worldview, relies upon the construction of epistemologically more sophisticated views of subject matter and of learning." It is quite evident that academic curricula with rigid and definite outcomes affect the quality of learning and that it impacts the cognition of the student. A child's concept development begins with an intermediate level of generality and gradually they understand the specific terms through differentiation and the generic terms through hierarchic integration (Anglin, 1977). It is reported that a proper concept development requires active involvement of learners in knowledge construction (Driver, 1989). This can only be achieved through teachers acting as "Guides" in student-centered classrooms where the focus is on what the students are 'doing' (Burnard, 1999; O'Neill and Tim McMahon, 2005). This brings us to one of the challenges faced by teachers—the vast premise of previous knowledge and varied competencies across students in a given classroom. Quoting Entwistle (2008) in a similar line, "Aiming at the average student no longer works well, because of these wider differences. Instead, strategies are needed to provide material in different ways that will suit students with different starting points and contrasting goals." In a study by Lawson (1983), it was observed that previous knowledge concerned with a given subject impacted the conceptual development and performance of the students in that subject. As a child progresses from lower to higher classes, he/she encounters the conceptual changes that come along the curriculum of senior classes. In that view, it is essential that the child builds an accurate cognitive framework in the junior classes so that it

reinforces the integrity of past (academic) experience(s) to the future information (Treagust and Duit, 2008).

Motivation Of The Study

So far, we discussed the different facets pertaining to concept development, teaching-learning discourses, and the associated challenges. But this paper is concerned with the notion of learning gaps—an ideadisdained by the teachers, textbook designers, and curriculum experts which refrains students from fabricating their cognitive schemas for a given concept. Also referred to as conceptual gaps, learning gaps denote a learner's inadequacy of correct and complete information with regard to a given discipline. Dirksen (2013) has explicated the types of learning gaps into five categories based on their conception: Knowledge gaps, Skills gaps, Motivation gaps, Environmental gaps and Communication gaps. Of these, the authors are interested in exploring knowledge gaps in biology learning that arose due to lack of exposure to complete and practical information. In a study, it was reported that such gaps can be conceptually exigent to the students, leading to misconceptions and deterring new information that eventually comes in advanced classes Jaewoo and Kun, (2005). One can argue on the different features of a 'good teacher', competencies and attributes of an 'effective educator' (Bernard Jr., 2015) but one can't deny that an obvious learning gap is a pervasive side-effect of the teaching-learning process, owing to the kind of delivery (of concept) by the teacher, textbook fallacies and the prevailing misconceptions within the students. Just as we started the paper with the notion of the warning at the metro stations, in many classes, the teachers are uncertain if their dialogue with students is properly mediated, or how to ensure there is no learning gap(s) in dispensing the course content as pointed by Ginsberg (2010) when she said, "We can mind the gap, but how do we get across it safely and effectively in the classroom?"

In that view, let us try to shift our attention towards the idea of diagrams which are considered as crucial elements in students' comprehension of various ideas. Diagrams are considered a credible source of information because of their ability to map visuospatial aspects of the world to visuospatial characteristics of paper, providing visuospatial inferences (Tversky, 2001). Corter et al. (2009) have mentioned, "*Although they (diagrams) appear simple, especially to experts, beneath the surface they depend on simplifications, spatial analogies, and social conventions that are usually learned implicitly.*" Diagrams foster an essential scientific skill of observation which is an initial point for studying scientific phenomenon (Johnston, 2009). But it is believed that learning from diagrams does not always happen as it seems; errors are commonly experienced even in the simplest of diagrams, the network of nodes and links (Corter et al., 2008)- the birth of a learning gap.

One of the ubiquitous tools used in the teaching-learning process is textbook, which is also a guide for the teachers and students Deshmukh and Deshmukh, (2009). Our Science textbooks lack in that original, or real-life images are majorly missing and instead schematic diagrams are given corresponding to the topics. Nevertheless these textbook images bear quite less resemblance to the real biological entity, thereby creating a perpetual 'learning gap' in the child regarding the concerned concept. In a study by Sangam and Jesiek (2014), it was revealed that textbooks can promote learning engagement among students and scaffolds the conceptual understanding, while they can constrain learning when misinterpreted and poorly conceived. But then the question arises—how to know if the students bear learning gaps? How to expose the source of the learning gaps so as to help students address them? Considering the research hitherto, the authors aimed to inspect the prevalence of learning gaps among the senior secondary students through a picture-based

questionnaire, and investigate their sources through interviewing the students.

Research Methodology

Research design

The present study involved a picture-based questionnaire in a descriptive survey framework that intends to explore the learning gaps across the students taught concepts of biology. As discussed, the study aimed to elucidate the students' perception of the textbook images seen in their biology books and also frequently asked in examinations. Their perception will unravel the learning gaps that render the students to fail in procuring a good learning experience that they might not understand at the present stage, but surely realise its significance in the future discourse of their academic career.

Research tool(s) for data

The picture-based questionnaire was developed consisting of 11 questions (every question had a picture assigned to it) based on the different topics taught in Class XI Biology (NCERT syllabus) such as concepts borrowed from the *Chapter 3: Plant Kingdom*, *Chapter 4: Animal Kingdom*, *Chapter 5: Morphology of Flowering Plants*, *Chapter 6: Anatomy of Flowering Plants*, *Chapter 10: Cell Cycle and Cell Division* and so on. Students find the syllabus of Class XI biology conceptually challenging owing to the extensive number of chapters. In addition to that, these questions covered almost every aspect of senior secondary level biology concept(s) expected to be known to a Class XI student. Two questions were from Class XII Biology (NCERT syllabus) borrowed from *Chapter 2: Sexual Reproduction in Flowering Plants*, and it was ensured that the chapter was covered in the classroom before the study. All the pictures were original (real-life) images of biological entities and events that were already taught to the students and they were asked to identify the images and



enlist their responses in the space provided corresponding to each image. The tool was validated by the concerned teachers to gauge its comprehensibility for the students, to which the teachers affirmed that the chosen pictures were the simplistic and easily deciphered ones for the given concept.

Research participants (Sample selection)

The study was conducted in Bhubaneswar, Khordha district of Odisha. A total of 53 students of Class XII (Biology stream) from a CBSE-affiliated (English medium) urban school participated in this study. The given school was easily accessible to the first author since he was working as an intern, and students were acquainted enough to give their consent for the study. The mean age of the students was 17.5 years (range 17–18 years). The majority of the students were females (39 of 53). This study did not focus on gender differences. All participants had been previously studying biology as a school subject from Class IX to XI which made the backgrounds of the students close to each other. Since this study was conducted during June–July 2016, all the Class XII students were taught Chapter 2 (Class XII textbook) as mentioned in the previous section.

Administration of the Study

The dates of the study were fixed in consultation with the principal of the school. Three days before the picture-based exercise, the authors interacted with the students and the students were advised to browse through the figures (as is referred) of different chapters given in their Class XI biology textbook and whatever recently covered in Chapter 12. It was told to the students that there are no assessment tests but it is a simple survey for our understanding of the teaching-learning process practised in their school.

On the study day for the picture-based exercise, each student received two sheets—one with the questions (Supplementary material #1) and one with the colored images (Supplementary material #2). The latter

sheet comprised blank spaces corresponding to every image for the students to write their responses. At the same time, the students were given the following instructions: “we would like each of you to consult the questionnaire (Supplementary material #1) and write your responses in the picture sheet (Supplementary material #2). You will be given 35 minutes, that is, one period to complete this activity. You can write your name only if you wish, but please mention your gender. This is not an examination, so there will be no assessment but it is a part of our study which involves students of your age.”

In addition to the above, to glean the reason behind students’ responses, the study employed an open-ended interview after examining the responses. The questions in the interview were meant to investigate the difficulties that the students encountered while identifying the images. The questions aimed at inspecting the source from which students were taught the diagrams and what were their difficulties in answering the exercise questions.

3.5: Data Analysis

The answers of the students were analysed in three categories, broadly as correct responses (I), close to correct responses (II) and incorrect responses (III). Certainly, the responses close to correct (II) and incorrect responses (III) signified the potential learning gaps among the students. So, it was further analysed for its frequency in view of the kind of the images—in other words, if the macroscopic biological units witnessed more learning gaps or the microscopic ones. The unresponsive images were considered as inability by the students to intuit the images and therefore, can be labelled as a “learning gap”. This supposition was verified during the interview when the students accepted that they were unable to infer the images as they have seen them for the first time or they were unable to relate them with any textbook diagrams. The statistical analysis of the responses was performed through PAST 4.0 which is a free software

for scientific data analysis, with functions for data manipulation, plotting, univariate and multivariate statistics.

Results

Comprehensive analysis of Student Responses

“Students’ learning engagement is an appropriate predictor of students’ behaviour

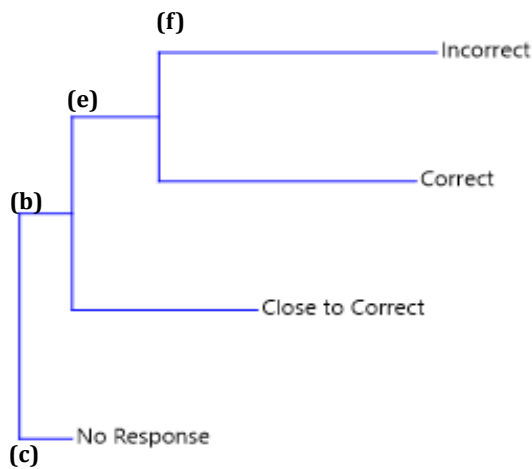

Figure 1. Neighbour-joining Model for Interpreting Students’ Responses

in the teaching-learning process and is an essential requirement for assuring the quality of education and achieving the desired learning outcomes”(Sumaiya and Masih, 2016). In the given paper, the authors endeavoured to interpret the students’ behaviour through their responses. In Figure 1, the responses of the students are modelled through neighbour-joining method wherein the two nodes are originating from (a), namely (b) and (c) where (b) branches further to (d) and (e) and (c) represents ‘no’ responses. The two nodes (d) and (e) are linked to the common ancestral node (b) which represents responses. (d) ends with the ‘close to correct’ responses and (e) terminates with branches (f) and (g) where they represent ‘incorrect’ responses and ‘correct’ responses respectively. The normal probability plot as shown in Figure 2 confirmed that the data set(s) is approximately normally distributed with tailing due to outliers at the extremes. The *Shapiro-Wilk W* for the given data set is 0.9247 (which is greater than $\alpha=0.05$) and therefore accepts the null hypothesis (Data sets are normally distributed).

The authors have detailed the learning gaps of the students by analysing their responses. The responses of the students are

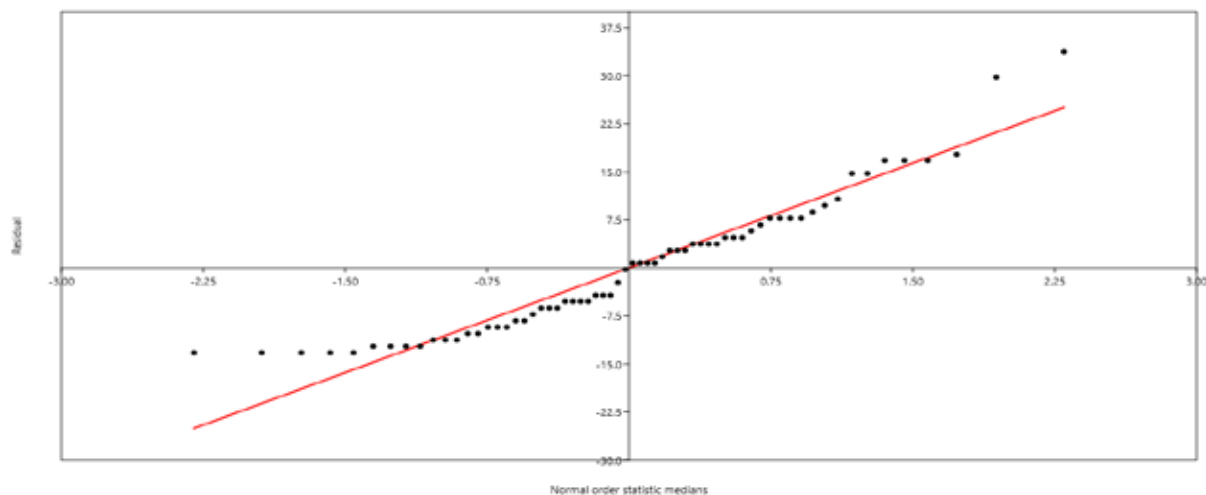

Figure 2. Normal Probability Plot for the Data Set of the Study



graphically depicted in Figure3 that provides a comparative notion of the learning gaps with respect to the questions.

Analysis of the Learning Gaps

The highest number of “incorrect responses” (47; 92.157 per cent) was found for the 4th

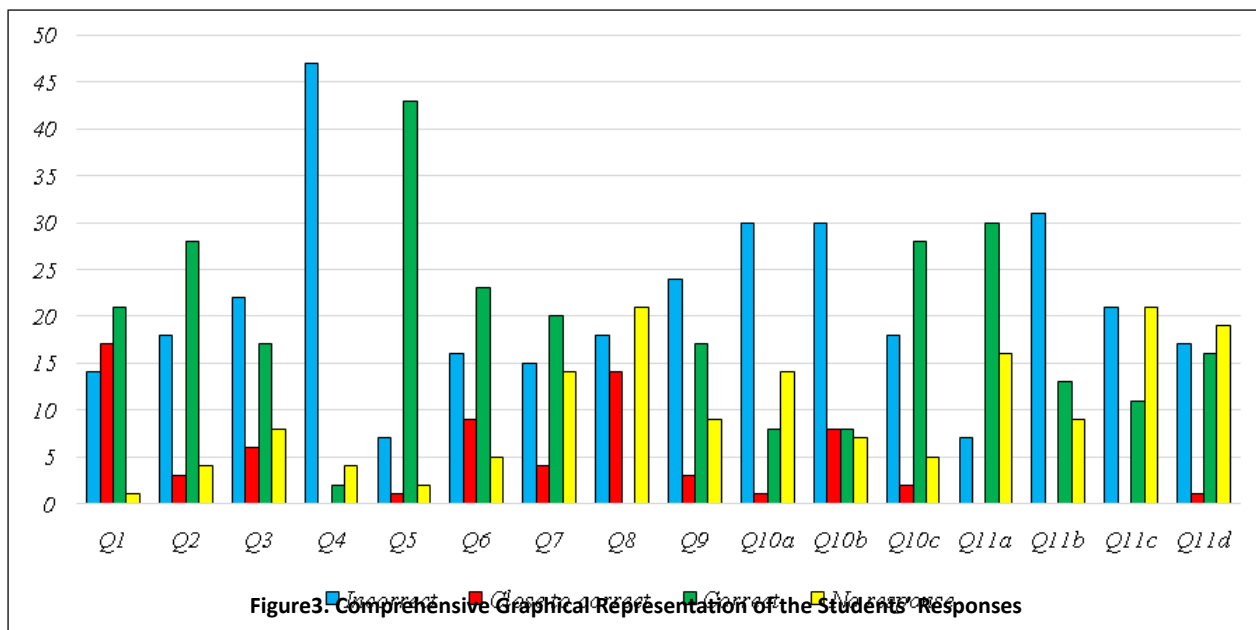

In relation to the given figure, Table 1 depicts a detailed understanding of the learning gaps among senior secondary students. The “Close to Correct” responses reflect the vulnerability of the students to imbibe a learning gap while “incorrect” responses show the number of students with learning gaps. The higher number of “incorrect” responses in the questions dealing with aestivation and placentation can be attributed to the

fact that they might have crossed the tests through the textbook concepts but unable to relate the learning outcomes with real-life experiences due to learning gaps. The highest number of “correct” responses in the 5th question (Anther TS) signified that the students could understand the given image and relate to what they have learnt in the classes.

question which was meant to identify the transverse section of a dicot leaf. We have detailed the responses and found that students are getting confused between the transverse sections of other vegetative parts of the plants like stems (25; 49.020 per cent), roots (5; 9.804 per cent), vascular bundles (12; 23.529 per cent) and other parts (5; 9.804 per cent) as shown in Table. 1. The 'incorrect' responses are the unheard echoes of learning gaps present in the cognitive schema of the given respondents. For the 11th question, the persistent occurrence of the term 'pentapetalous' and 'dipetalous' signified that the students are using their observation skills after witnessing the pictures and scientific reasoning to answer the questions, validating the importance of real-life pictures in science education. The pictures given in their textbook with respect to the given concepts are distinctively different from the real-life images and that must be the underlying confusion in the responses—students marked quincuncial (2; 3.77 per cent) and vexillary (1; 1.89 per cent) for valvate (Q11, a); imbricate (8; 15.09 per cent) and valvate (11; 20.75 per cent) for twisted (Q11, b); quincuncial (1; 1.89 per cent), twisted (13; 24.53 per cent), vexillary (3; 5.66 per cent) and valvate (2; 3.77 per cent) for imbricate, etc. In a similar line, the "incorrect responses" can be explained for the 10th question where the learning gaps befuddled the students to ascribe the correct "placentation" to the right picture. In this question, many students reported their responses as "cucumber", "bottle guard", "lady finger" and "pea". This concludes that the students simply couldn't apply their theoretical understanding of "placentation" to the real-life experiences due to practical unfamiliarity with the concept. An interesting observation lay with question 2 portraying the picture of a "sponge" where 18 (33.96 per cent) students mentioned it as a "coral", the authors believed that the students wouldn't have committed this mistake if they were shown a real-life image of these specimens while the chapter was taught or if the textbook contained it.

The "close to correct" responses indicated that the students know the answer to a given question but the learning gaps impeded them to write the correct answer. For example, the 1st question representing angiospermic ovule got 17 such "close to correct" responses like egg cell (1; 1.89 per cent), embryo (9; 16.98 per cent), ovule development (4; 7.55 per cent), female gametophyte (2; 3.77 per cent) and ovary development (1; 1.89 per cent). All these responses are proximal to the correct answer but unfamiliarity with the real-life image of an ovule caused the learning gap. Similarly, the 6th question of Nereis received 9 "close to correct" responses wherein the students mentioned Annelids (1; 1.89 per cent), Annelida: Dero (5; 9.804 per cent) and Worm (3; 5.66 per cent). It is clear that students tend to identify the picture correctly but the learning gap occupying their cognitive space caused the mistake. The "close to correct" responses that came from Q3 (Metaphase) also indicated similar notion where the respondents provided answers like cell division (3; 5.66 per cent), mitosis (2; 3.77 per cent) and chromosome (1; 1.89 per cent). All these responses were close to the right answer but scientifically erroneous for the given picture-question. It is also observed that "close to correct" responses are more for the two microscopic concepts—Q1: Ovule 17 (32.08 per cent), Q8: Ciliated columnar tissue 14 (26.42 per cent)—if analysed individually. The authors conclude that real-life images should be stressed for the microscopic biological entities since they tend to help clear the confusion with the textbook images.

Qualitative analysis of the Interview

Owing to their acquaintance with the first author of this study, all the students mentioned their names in the exercise sheet. The rounds of interview were conducted as a later part of the study where only selected students (who expressed the possession of learning gaps) were interviewed in an amiable classroom environment. It was observed that the highest number of "no responses"



(21; 41.176 per cent) were found for Q8 and Q11(c) which were associated with the transverse section of ciliated columnar epithelial tissue and a flower with imbricate aestivation respectively. In the interview, it was found that the inability of the students to respond to the said questions were primarily because of two reasons: “seen something like this but can’t find a resemblance to the textbook diagram” [31.373 per cent for Q11 (c)] and “never seen such an image and saw it for the first time in questionnaire” (23.529 per cent for Q8) (see Figure 4). The highest number of “correct responses” (43; 84.314 per cent) was observed for Q5 which can be attributed to the fact that the question belonged from Chapter 2 of their Class XII textbook, which has been taught practically

and the slide preparation of transverse section of the anther(s) was a part of their lab exercise. There is a trend observed in the correct responses of Q10 (a, b, c) and Q11 (a, b, c, d) which can be ascribed with a reason: for Q10 (a, b), the number of correct responses is considerably lower than that of Q10 (c). When asked during the interview, the students informed that while teaching the topic in class, the teacher happened to collect a “pair of pea pods” from the school garden and showed that as an example of “marginal placentation” while no such teaching practice was exercised for the former two.

For Q11 (a, b, c, d), the number of correct responses was much higher in Q11 (a) than the rest of the sub-questions; when the authors tried to find the reason

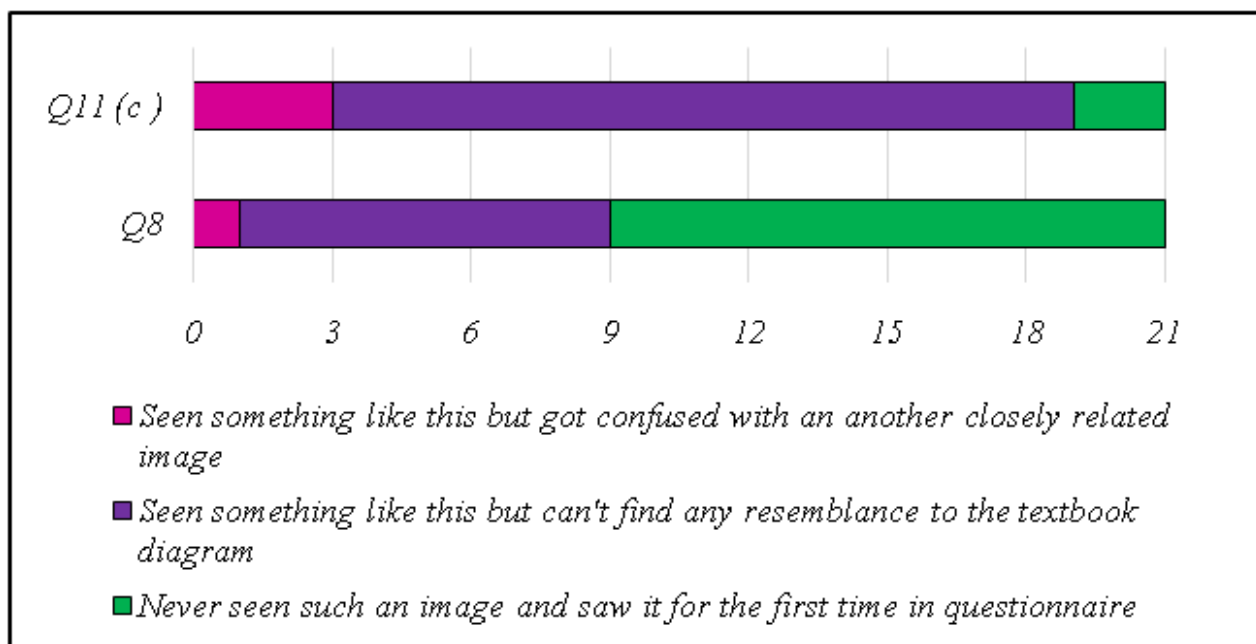

Figure 4. Qualitative Assessment of Interview Reactions for ‘No’ Responses

through interview, the students recollected that the teacher showed them the flower of “Periwinkle” while taking the class on “aestivation” and pointed the flower as an example of “valvate” aestivation, which was not done for other kinds of “aestivation”. While conducting the interviews, the authors observed that students tend to believe in their learning gaps since they relate it to their

experiences and if unattended, the students consider that as valid information. For example, Q9 was meant for identification of *Funaria* where we noticed that few students (3; 5.882 per cent) wrote seed germination as an answer. When asked in the interview, the students admitted that they have spotted gram sprouts and the given image looks a lot like that. Similar learning gaps

were witnessed for Q6 (16; 30.19per cent “incorrect” responses) which was associated with an image of *Nereis*. 7 (13.21per cent) students labelled it as millipede, 2 (3.77per cent) students labelled it as centipede (one student wrote *Kankhajura* which means centipede in Hindi), 3 (5.66percent) students labelled it as earthworm. In the interview, the students replied that they associated the image with what they have experienced around them with similar morphological features and accordingly answered the question. In the 8th question (Ciliated columnar epithelium T.S.), 4 (7.55 per cent) students mentioned it as the image of Testis T.S. while 3 (5.66 per cent) students marked it as cells of saliva/cheek/hair, etc. In the interview, the students consensually agreed that these structures are closely related and the textbook images tend to be similar- here, the role of the teacher becomes impeccable to provide the students with real-life images to avert such misconceptions. When we interviewed the 47 students who responded incorrectly for the 4th question (maximum incorrect responses), we found that more than 80 per cent students (39) reported that they were very confused with the transverse section(s) of plant parts, as the textbook was filled with many images and they never saw a real-life image or specimen of the same. In the interview, 18 (33.96 per cent) students reported for the second question (sponge) that they have seen structures similar to the questionnaire in National Geographic shows. They couldn't differentiate between a coral and a sponge since they believed both were synonymous due to resemblance in their structures. They further added that the textbook contained a figure of sponge but not of a coral, and the teacher never showed any image of the biological species.

Discussion

“The vision of NCF 2005 to reorient the perception towards ‘learners and learning’ and to follow a holistic approach towards their development seems to have been realised

only partially” Sumaiya and Masih, (2018). According to the framework, experiential learning is practiced in a classroom in which a teacher would act as a facilitator, encouraging students’ creativity and students would actively engage themselves in the process of knowledge construction. Presentation of information by textbooks and teachers is consociated with the birth of misconceptions Barrass, (1984) and our findings strongly support the given notion. All the students affirmed that neither any real-life images were shown to them nor any hands-on activities (practical classes) were conducted. The authors also found that textbook illustrations are a hidden impetus to the development of learning gaps as was reported by Buckley (2000). Our textbooks includeschematic diagrams of the biological concepts which fail to replicate the features of the original (real-life) phenomenon/entity, thus, proffering the developing minds to conceive the learning gaps. Images are considered to be a decisive medium of (transformative) information transmission which can cause learning difficulties if they do not reinforce with previous ideas of the students Colin et al., (2002). Though the authors hypothesised that there will be a distinct difference between the correct responses for the questions with macroscopic images and questions with microscopic images but no such notable variations were recorded. In addition to that, the authors could not trace a specific pattern in the learning gaps of the macroscopic and microscopic concepts. This could be because each student has a unique style of learning and reception of information. Yip (1998) and Dikmenli and Cardak (2004) evaluated science teachers’ knowledge on circulatory systems and they found that most teachers were unable to relate different concepts pertaining to the said topic. Through the interviews, the authors also realised that there was a lack of subject competence in the teachers, particularly when the students mentioned, “We asked for some examples on Valvate aestivation apart from the Periwinkle

flower, but Ma'am said this is the only example along with the one mentioned in the book! So, write these names in the exam!" It has been pointed out by Colin et al. (2002) that teachers are far from agreement when they were informed about the difficulties faced by the students. Though we did not explore the teacher's view but the occurrence of "incorrect" and "close to correct" responses in high frequency can be predicted as a result of teachers' lack of awareness towards the students' learning gaps.

The authors accept that it may not be practically possible for the teachers to provide hands-on activities for every chapter in biology but they can at least fetch help from ICT-based teaching aids to familiarise students with the original (real-life) images of the biological concepts. Posner et al. (1982) elaborated conceptual change based on the theory of constructivism and termed it as the process where learners comprehend and accept ideas because those are perceived as intelligible and rational by the learners. Therefore, the authors support their findings and convey to the members of the textbook development committee, curriculum developers and teachers to consider the importance of original (real-life) biological images for an unerring delivery of the subject content (Supplementary material #3). In addition to that, the authors also propose picture-based questionnaires as a plausible assessment practice for diagnosing learning gaps among students.

6. Implications

In the context of Indian education, this paper can be used as a baseline study to ratify similar research efforts in different disciplines of science and social sciences. The implications of the paper can be as follows:

- a. Creating the lesson plan such that students can be made aware of the real-life images through visual aids or hands-on activities.

- b. Helping teachers to design an assessment framework to identify the learning gaps and eventually address them.
- c. Exploring the learning gaps of students through the lens of gender.

7. Conclusion

The study investigated the learning gaps of senior secondary students in biological concepts and concluded that use of original (real-life) biological images as an epistemic practice at least in biology. Images play a pivotal role in supporting the teaching-learning practices and visually stimulate the students to observe and relate the theoretical takeaways with the practical world. Observation is the basic scientific attribute that paves the way for higher scientific skills, like interpretation of data and deducing a conclusion. Therefore, a learning gap in the understanding of textbook images will eventually encumber their observation and ability to relate to the real-life biological phenomenon, thus negatively affecting the higher order scientific skills. A student-centric delivery of information in a classroom can be a remedy when the teachers mind the gap between what her/his students know and what she/he wants to teach them (Barr and Tagg, 1995). As stressed by Janosz (2012), education needs to emphasise on transforming the learners from 'passive absorbers of knowledge' to 'active constructors of meaning', and our findings tend to support this assertion. With the given goals in mind, the next step is to consider how to scaffold this study for other disciplines of science and how can teachers provide enough help that the students achieve a complete understanding, eliminating the learning gaps. We recognise the inclusion of original (real-life) images as a scientific practice in order to maximise the students' understanding of biological sciences.

References

- ANGLIN, J. 1977. *Word, Object, and Conceptual Development*. W.W. Norton and Company Publishers, New York, US.
- AUSUBEL, D.P., J.D. NOVAK AND H. HANESIAN. *Educational Psychology: A Cognitive View*. 2nd Ed. Holt Rinehart & Winston Publishers, New York, US.
- BARR, R.B. AND J. TAGG. 1995. From Teaching to Learning: A New Paradigm for Undergraduate Education. *Change*. 13-25.
- BARRAS, R. 1984. Some Misconceptions and Misunderstandings Perpetuated by Teachers and Textbooks of Biology. *Journal of Biological Education*. 18. pp. 201–206.
- BERNARD JR., M. 2005. *The Good Teacher: An Investigation of the Core-Competencies and Attributes of an Effective Educator* (Master's Thesis). Department of Curriculum, Teaching and Learning, Ontario Institute for Studies in Education, University of Toronto, Toronto, Canada.
- BLOOM, B.S. 1956. *Taxonomy of Educational Objectives, Handbook: The Cognitive Domain*. David McKay Publishers, New York, US.
- BUCKLEY, B. 2000. Interactive Multimedia and Model-based Learning in Biology. *International Journal Science Education*. 18. pp. 201–206.
- BURNARD, P. 1999. Carl Rogers and Postmodernism: Challenged in Nursing and Health Sciences. *Nursing and Health Sciences*. 1. pp. 241–247.
- COLIN, P., F. CHAUVET AND L. VIENNOT. 2002. Reading Images in Optics: Students' Difficulties and Teachers' Views. *International Journal of Science Education*. Vol. 24, No. 3. pp. 313–332.
- CORTER, J.E., J.V. NICKERSON, B. TVERSKY, D. ZAHNER AND Y.J. RHO. 2008. *Using Diagrams to Design Information Systems*. In B.C. Love, K. McRae and V.M. Sloutsky (Eds.), Proceedings of the Thirtieth Annual Conference of the Cognitive Science Society. pp. 2259–2264. Cognitive Science Society, Austin, TX.
- CORTER, J.E., Y.J. RHO, D. ZAHNER, J.V. NICKERSON AND B. TVERSKY. 2009. Bugs and Biases: Diagnosing Misconceptions in the Understanding of Diagrams. *Proceedings of the Annual Meeting of the Cognitive Science Society*. Vol. 31, No. 31. pp. 756–761.
- DESHMUKH, N.D. AND V.M. DESHMUKH. 2009. A Study of Students' Misconceptions in Biology at the Secondary School Level. Proceedings of epiSTEME 4, HBCSE (TIFR), India.
- DIKMENLI, M. AND O. CARDAK. 2004. A Study on Misconceptions in the 9th Grade High School Biology Textbooks. *Eurasian Journal of Educational Research*. 17. pp. 130–141.
- DIRKSEN, D. J. 2013. *Student Assessment: Fast, Frequent, and Formative*. R&L Education, USA.
- DRIVER, R. 1989. Students' Conceptions and the Learning of Science. *International Journal of Science Education*. Vol. 11, No. 5. pp. 481–490.
- ENTWISTLE, N. 2008. *Taking Stock: Teaching and Learning Research in Higher Education*. Ontario International Symposium on Teaching and Learning in Higher Education, Ontario, Canada. pp. 25–26.
- FINK, L.D. 2003. *Creating Significant Learning Experiences*. Jossey Bass Publishers, San Francisco, CA.
- GINSBERG, S.M. 2010. Mind the Gap in the Classroom. *The Journal of Effective Teaching*. Vol. 10, No. 2. pp. 74–80.
- JANOSZ, M. 2012. Part IV Commentary: Outcomes of Engagement and Engagement as an Outcome: Some Consensus, Divergences, and Unanswered Questions. pp. 695–703. In S.L. Christenson, A.L. Reschly and C. Wylie (Eds.), *Handbook of Research on Student Engagement*. Springer Publishers, New York, US.
- JAEWOO, K. AND O.W. KUN. 2005. Comparison of the Explanations about the Gravitational Force in 7th Grade Science Textbooks with Students' Conceptions about it. *Sae Mulli*. Vol. 51, No. 1. pp. 30–36.
- JOHNSTON, J.S. 2009. What Does the Skill of Observation Look Like in Young Children? *International Journal of Science Education*. Vol. 31, No. 18. pp. 2511–2525.
- LAWSON, A.E. 1983. Predicting Science Achievement: The Role of Developmental Level, Disem-

- bedding Ability, Mental Capacity, Prior Knowledge, and Beliefs. *Journal of Research in Science Teaching*. 20. pp. 117–129.
- O'BRIEN. 2008. *Teaching as Translation: An Investigation of University Teachers' Pedagogical Content Knowledge, Reasoning and Intention* (Doctoral Thesis). School of Education and Professional Studies, Griffith University, Queensland, Australia.
- O'NEILL, G. AND T. McMAHON. 2005. *Student-centred Learning: What Does it Mean for Students and Lecturers? Emerging Issues in the Practice of University Learning and Teaching*. AISHE Publications, Dublin.
- POSNER, G.J., K.A. STRIKE, P.W. HEWSON, AND W.A. GERTZOG. 1982. Accommodation of a Scientific Conception: Toward a Theory of Conceptual Change. *Science Education*. 66. pp. 211–227.
- SANGAM, D. AND B.K. JESIEK. 2015. Conceptual Gaps in Circuits Textbooks: A Comparative Study. *IEEE Transactions on Education*. Vol. 58, No. 3. pp. 194–202.
- SUMAIYA, B. AND A. MASIH. 2016. *Enhancing Students' Learning Engagement: A Less Addressed Objective of Teacher Education*. Paper presented at International Education Conference, New Delhi, India.
- SUMAIYA, B. AND A. MASIH. 2018. Searching the Missing Link for Assuring the Quality of Enacted School Curriculum. *Journal of Indian Education*. Vol. 44, No. 2. pp. 25–39.
- TREAGUST, D.F. AND R. DUIT. 2008. Conceptual Change: A Discussion of Theoretical, Methodological and Practical Challenges for Science Education. *Cultural Studies of Science Education*. Vol. 3, No. 2. pp. 297–328.
- TVERSKY, B. 2001. *Spatial Schemas in Depictions*. In M. Gattis (Ed.), *Spatial Schemas and Abstract Thought*, pp. 79–111. MIT Press, Cambridge, England.
- YIP, D.Y. 1998. Identification of Misconceptions in Novice Biology Teachers and Remedial Strategies for Improving Biology Teaching. *International Journal of Science Education*. Vol. 20, No. 4. pp. 461–477.

Astha Singh
astha.singh023@gmail.com
Amita Bajpai
amitabajpai63@gmail.com

Visualising Inclusive School

Abstract

The purpose of this study is to reflect how inclusion can be made possible in schools. In this paper, the researcher has carried out a qualitative review of previous studies to know what strategies can be used for inclusive schools. The researcher has categorised the strategies into two types: general strategies and specific strategies. General strategies include location of classroom, classroom environment, sitting arrangement in the classroom, support for physical and mental well-being, Teacher Education and regular training and specialised staff. Specific strategies include teaching strategies, IEP of children with special needs, teaching methods, curriculum and assessment, reinforcement, adaptation, accommodation and modification, assistive technologies, and life skills. Keywords: children with special needs, inclusion, general classroom.

“Strength lies in differences, not in similarities.”- Stephen Covey

Introduction

In the past, people believed that special children were not capable of learning. They were not considered a part of society. Such children were forced to remain confined within the four walls of home and away from everyone. They were not considered to be a part of regular schools. Later on, special schools were introduced for children with special needs.

A special school caters to children who have special educational needs due to learning difficulties, physical disabilities or behavioural problems. However, in time there has been a growing consensus that special children also have the same rights as any other child, and they ought to be included as active participants of their community. Thus, they began to be integrated into general schools. But general schools made very few changes to their curriculum and pedagogy to suit the needs of children with special needs. As a result, teachers were not always able to support the children with special needs to help realise their potential.

Inclusion aims to provide an educational environment in which the special child feels comfortable in a conventional classroom. This means that the design, physical structure, curriculum and teaching methodology are constructed by keeping the needs of the special child in mind. This is done in a way that it can be accessible to all children without any discrimination. It is designed so that children with special needs can also be a part of the regular classroom environment. Inclusion provides a platform to the children with special needs to grow fully to their potential in an educational environment they share with every other child.

The Gazette of India published the Rights of Person with Disabilities Act 2016, which states inclusive education to mean “a system of education wherein students with and without disability learn together and the system of teaching and learning is suitably adapted to meet the learning needs of different types of students with disabilities.”

Article 24 of the United Nations Conventions on the Rights of Persons with

Disabilities (UNCRDP) which is related to the Right to Inclusive Education for all persons with disabilities states that all the children with special needs should also have the right to get quality education and should not be discriminated on any basis. Every child should have access to quality education at all levels—primary, secondary, tertiary, vocational, and life-long learning.

Education should be available to everyone in the communities in which they live. Children with special needs should not be excluded from school education. An aim of inclusive education is to foster the full development of all the children, including that of children with special needs, in the general (regular) school setting. The main basis is to support children with special needs to participate fully in society and make everyone aware of human rights, diversity, tolerance, and respect. Children should be placed in the least restrictive environment or in the most natural settings (Dahle, 2003).

There are challenges in practising inclusion in schools such as lack of awareness about teaching methods appropriate for children with disabilities, inaccessible environment, negative attitudes of school personnel, lack of training, and lack of involvement of parents. There are some strategies that can be used to make inclusion successful in schools.

Strategies For Inclusion

Strategies can be classified into two ways: general strategies and specific strategies.

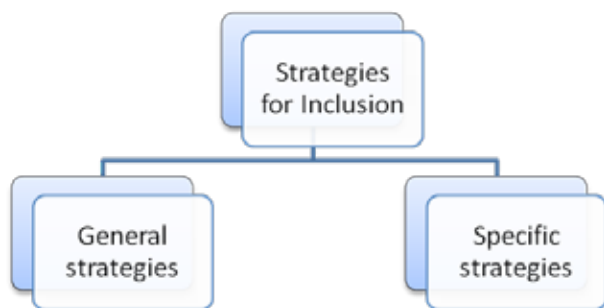

General Strategies

Location of class:

Classes should be on the ground floor. If they are on the first floor, there should be a ramp along with stairs, as it can be difficult for children with physical disability to use stairs. Thus, the classroom should be at a location where it is accessible to all children with and without special needs.

Classroom environment:

Class should be appropriate according to the number of children. There should not be more than 25–30 students in the classroom. Classrooms should be well-equipped with technologies like speakers, mic, etc. Innovative technologies should be used in the classroom, like software tools (interactive white boards, blogs, wikis, etc.), and visual media literacy tools (concept maps, cartoons, digital storytelling, graphing calculators, geo-spatial technologies, personal digital assistants and use of MP3 files or podcasting, webinar) (Block2:Pedagogy For Inclusive Education, RCI). Activity-based learning should be encouraged in classrooms (National Center on Educational Restructuring and Inclusion, 1994).

Sitting arrangement in the classroom:

Arrangement of the class should be such that all children should be visible to the teacher and children are also able to see the teacher. The sitting arrangement should be made in a semicircular way in the class, or if that is not possible, then children with special needs should be seated in the front row. However, there shouldn't be any segregation within the classroom. When children with special needs are made to sit alongside other children, it inculcates a feeling of inclusivity in the classroom. The other children also learn to develop a kind and helpful attitude towards children with special needs. Special children should be so seated that they are able to hear and see clearly so as to maximise

understanding in class. They should not be seated near windows and bright light as it can create glare to them.

Support for Physical and Mental Well-Being-

The **Oxford English Dictionary** defines well-being as the state of being comfortable, healthy or happy. Social and emotional well-being lies under the mental well-being. Sports, exercises and yoga programmes should be a part of the curriculum in order to ensure physical well-being of children. Such activities must be suitably adapted for children with disabilities so they are not left out. Promoting student's well-being and their emotional and physical safety is a fundamental feature of school life (National Council for Special Education, 2011). Schools should provide care (ensure physical and emotional welfare of the child) to the children enrolled in their school. Teachers should be empathetic, friendly, patient and polite so that children can build emotional connections and feel welcome.

Teacher Education and Regular Training:

Teachers must be trained to work effectively in inclusive environments and teachers with disabilities must also be recruited and trained. Teachers with disabilities in schools will help to promote equal rights, provide unique expertise and skills, contribute to breaking down barriers, and serve as important role models.

Specialised/ Trained Staff:

There should be a General Education teacher. There should also be a special educator who can help to determine the needs of children with special needs. School administrators must provide indirect services by giving proper implementation of policies, procedures and financial responsibilities. There should be school psychologists, counselors, speech language pathologists (for communication issues), occupational therapists (for fine motor control issues), physiotherapists (for

gross motor control issues), audiologists and other relevant health and social service professionals (Bateman & Cline, 2016).

Specific Strategies

Individualised Educational Plan-

There should be an individualised education plan (IEP) for each child with disability. The IEP is a blueprint for the education of children with special needs. It should be created by a special team comprising the general teacher, special educator, the child's parents, a psychologist, a counselor, a physiotherapist and any other people who may be involved with the child's education and rehabilitation. The IEP is one of the main elements of the Individuals with Disabilities Education Act (2004) by the Govt. of America. It is a written document stating the support and accommodation a child needs, and this document assists parents and teachers in assessing the potential of the child and helping them to develop fully. For the inclusive education concept, the 504 plan (support and remove barriers for children with disability in school) was designed to ensure children with special needs are allowed to learn in the general classroom environment. The IEP sets learning goals and describes the services the school will provide.

Teaching Method:

Teachers should recognise diversity among learners in the class and develop classroom environment according to the needs of children with disabilities. Teachers should use various teaching methods, depending upon the nature of disabilities, to help them make the effort to understand with ease. They should use sign languages and visual symbols in classroom discussions as it will enhance learning and giving them more than one way for communication with children. Teachers should pay attention to verbal directions and use fewer words and a clear message (Friedlander, 2009) to avoid complexity while delivering information in class. In the beginning, the teacher should



prompt answers to teach the child how to answer. Teachers should also use task analysis (break learning materials into parts) followed by a step-by-step approach and teaching parts at a time—the second part is made available after completing the first part and there should be repetition and practice again and again till they understand the topic. Teachers should make them learn through concrete objects like blocks for counting, alphabets to learn and recognise, and modeling clay to make objects. Teachers should try to demonstrate everything while teaching and there should be more use of activities to involve them in hands-on experience. Activities should be so constructed that they must relate to the child's prior knowledge. These should be meaningful, interesting, and content-based to develop critical thinking and problem-solving skills in children. One teach one assist model should be used (Casale-Giannola, 2012) in which a special teacher plays the role of assistant. There are some models by the National Center on Educational Restructuring and Inclusion (1994) for teachers to support inclusion. These include a co-teaching model (special education teacher co-teaches alongside with general education teacher), parallel teaching (special education teacher teaches small group of children from children with special needs in a general classroom), co-teaching consultant model (special education teacher teaches children with special needs separately but also teaches in the general education classroom for several hours), a team model (special education teacher teams up with one or more general education teachers to form a team), methods and resource teacher model (special teacher whose children distributed in general classroom works with general education teacher), cooperative learning (group of students with a wide range of skills and characteristics to work together).

Adaptation, Accommodation and Modification:

All students in the inclusive classroom are not the same. So, adaptation, accommodation and modification must be done as per the needs of children in order to enhance their learning in inclusive classrooms. Teachers can adapt, accommodate and modify according to the needs of children.

Curriculum & Assessment:

There should be a modified curriculum for special children according to their needs and potential. They should teach according to their IEP (National Council for Special Education, 2016). Alternate goals should be set for them. They are not imposed to learn the whole curriculum. There should be an individualised curriculum based on their individuality and their assessment should be done in natural settings and given sufficient time to respond according to their potential. The curriculum should also include activities of daily life, health and hygiene. There should be flexibility in the curriculum. Assessment should be done in such a manner that it helps develop the strengths and abilities of all children rather than highlighting their limitations. Assessment should be based on the quantity of improvement.

Reinforcement:

Always use positive reinforcement if children give the right answer. There should be use of verbal and non-verbal cues to encourage answers. Pause for a short time for the child to respond, and allow them to discuss in groups sometimes. This will help them in learning from other children in the classroom. Provide clear and defined examples of the behaviour that is expected.

Assistive Technologies:

Use assistive technology to support children in learning and assessment situations.

The school should use a range of assistive technologies based on individual learner needs like alternative access for children who have limitations in physical strength, movement and coordination (for example: pencil grips, switches, supportive seating) (Block 2: Pedagogy for Inclusive Education, RCI). Alternative and augmentative communication is used to replace or supplement speech for children who have problem in speaking or writing (for example: speech-generating device, communication app for tablet device), literacy support software for children where written information is a barrier to their learning and engagement (for example: text to speech, speech to text, word prediction), visual supports to assist children to understand concepts and organise ideas, as alternative ways to deliver information to children with low vision (for example: software that magnifies text, graphic organiser, visual timetable).

Life Skills:

Some children with special needs lack in necessary life skills. Teachers should tell them and make them learn some basic communication skills (Dahle, 2003), life care skills, personal safety, following directions, how to see time from the digital clock, and then analog clock, signing your name, money management, how to respond to their name being called out, survival reading skills, social skills and practical skills. Teachers should encourage critical thinking, decision-making, problem-solving, and other coping life skills in special children to promote their self-reliance and independent living capabilities.

These strategies should be implemented in inclusive schools for children with special needs:

- Ramps should be made in schools that students can access the classrooms easily.
- Proper care should be taken of children's physical and mental well-being.
- Well trained teachers should be recruited in inclusive schools.
- Individualised educational plan should be made.
- Accommodation, adaptation and modification should be done by teachers according to the needs.
- There should be modified curriculum.
- Assessment should be done according to the improvement.
- Assistive technologies should be used.
- Classroom should not have more than 20-25 students in one classroom.
- Teachings of life skill should be given.
- Various teaching methods should used.
- Staff and teachers should be polite and well trained.
- They should also appoint well trained teachers with special needs.

Conclusion

In order to make inclusion in schools successful, the points discussed above can be incorporated.



References

- BATEMAN, D.F. AND J.L. CLINE. 2016. A Teacher's Guide to Special Education. ASCD, Alexandria, Virginia.
- CASALE-GIANNOLA, D. 2012. Comparing Inclusion in the Secondary Vocational and Academic Classrooms: Strengths, Needs, and Recommendations. *American Secondary Education*. pp. 26–42.
- DAHLE, K.B. 2003. Services to Include Young Children with Autism in the General Classroom. *Early Childhood Education Journal*. Vol. 31, No. 1. pp. 65–70.
- FRIEDLANDER, D. 2009. Sam Comes to School: Including Students with Autism in your Classroom. *The Clearing House: A Journal of Educational Strategies, Issues and Ideas*. Vol. 82, No. 3. pp. 141–144.
- NATIONAL CENTER ON EDUCATIONAL RESTRUCTURING AND INCLUSION. 1994. National Study of Inclusive Education. City University of New York, NY.
- NATIONAL COUNCIL FOR SPECIAL EDUCATION. 2011. Inclusive Education Framework: A Guide for Schools on the Inclusion of Pupils with Special Educational Needs.
- UNITED NATIONS INTERNATIONAL CHILDREN'S EMERGENCY FUND. 2017. Inclusive Education. Understanding Article 24 of the Convention on the Rights of Persons with Disabilities.
- <http://www.disabilityaffairs.gov.in/upload/uploadfiles/files/RPWD%20ACT%202016.pdf> retrieved on 16/01/2020 at 01:32pm
- <http://www.rehabcouncil.nic.in/writereaddata/Block2accie.pdf> retrieved on 20/12/2019 at 03:00pm
- <https://teachingtools.ophea.net/activities/early-learning-resource/strategies-inclusionretrievedon15/02/2020at02:50pm>
- <https://www.kqed.org/education/75955/5-effective-strategies-for-the-inclusive-classroomretrievedon09/01/2020at01:45pm>
- <https://www.schoolsmith.co.uk/mental-health-wellbeing-mindfulness-schools/retrievedon31/12/2020at07:30pm>
- <https://www.teachertoolkit.co.uk/2017/05/25/10-inclusion-strategies-for-teachers/retrievedon16/02/2020at03:00pm>