

# **BHARATHIDASAN UNIVERSITY**

**TIRUCHIRAPPALLI – 620 024**

## **CENTRE FOR DISTANCE EDUCATION**



## **HEALTH AND PHYSICAL EDUCATION**

### **B.Ed. II YEAR**

**Chairman**

**Dr.V.M.Muthukumar**

Vice-Chancellor

Bharathidasan University

Tiruchirappalli-620 024

**Vice-Chairman**

**Dr.C.Thiruchelvam**

**Registrar**

Bharathidasan University

Tiruchirappalli-620 024

**Course Director**

**Dr. R. Babu Rajendran**

**Director i/c**

**Centre for Distance Education**

Bharathidasan University

Tiruchirappalli-620 024

**Course Material Co-ordinator**

**Dr.K.Anandan**

Professor & Head, Dept .of Education

Centre for Distance Education

Bharathidasan University

Tiruchirappalli-620 024

**Author**

**Dr.A.Edward William Benjamin**

Associate Professor ,Dept.of Education,CDE

Bharathidaan University

Tiruchirappalli-620 024

**The Syllabus adopted from 2015-16 onwards**

**SYLLABUS**  
**ELECTIVE COURSE**  
**HEALTH AND PHYSICAL EDUCATION**

**Total Marks: 100**

**Duration of Examination: 3 Hrs**

**Internal Assessment: 25**

**External Assessment: 75**

**OBJECTIVES**

After completing the course, the student-teacher will be able to

1. Acquire knowledge about physical and health education.
2. Understand the rules and the regulations of sports and games.
3. Develop the skills in organizing the physical education programmes in schools.
4. Develop the activities required for organizing physical education meets and events.
5. Acquire knowledge about recreation, health and safety education
6. Acquire knowledge about common communicable diseases.
7. Understand the nature of injuries and to provide first aid.
8. Acquire knowledge about yoga and physical exercises.
9. Create awareness on different aspects of health and fitness.
10. Understand the diet modification in the treatment of under-weight and obesity.

**COURSE CONTENT/SYLLABUS**

**UNIT I Introduction to Physical Education**

Meaning, Definition, Aims, Objectives, Scope and Importance of Physical Education - Physical Fitness- Meaning, Definition, Components and Benefits - Origin and Development of Ancient and Modern Olympics - Olympic torch, Olympic Flag, Marathon Race, Difference between Ancient and Modern Olympic Games - Recreational activities.

## **UNIT II Methods, Organisation and Administration**

Methods of teaching physical activities - Parts and Preparation of general lesson plan - Fixtures: Single Knock out and Single League - Organisation of an athletic meet - Layout, Basic Skills, Rules and Regulation of Badminton, Cricket, Football, Hockey, Kabbadi and Volleyball- Organisation of Intramural and Extramural Competitions and Tournaments

## **UNIT III Concept of Health Education**

Meaning, Definition, Aims, Objectives and Importance of Health Education - Nutrition - Malnutrition - Personal Hygiene - Health Education in Schools - Health Instruction, Health Services, Safety Education: Importance with reference to Schools, Play fields, Road, School and Home - First Aid: Road, Water, Fire accidents and Snake bite - Common sports injuries: Strain, Sprain, Contusion, Laceration, Fractures and Dislocation.

## **UNIT IV Causes and Prevention of Diseases**

Life style disorders: Heart diseases, Cancer, HIV/AIDS, Reproductive Helpless Health, Osteoporosis, Depression, Intentional & Unintentional Injuries, Diabetes and Obesity - Back Pain: Causes, Symptoms and Prevention - Addiction: Alcoholism, Smoking and Drugs - Impact of Pollution on Human health - Communicable diseases: Malaria, Swine flu, Chikungunya, Typhoid, Cholera, Small Pox, Tuberculosis and Dengue: Causes, Symptoms and Prevention.

## **UNIT V First Aid-Principles and Uses**

Principles of first aid, First aid equipments, Fracture - causes and symptoms and the first aid related to them, Muscular sprain causes, symptoms and remedies, First aid related to hemorrhage, respiratory discomfort, First aid related to natural and artificial carriage of sick and wounded persons, Treatment of unconsciousness, Treatment of heat stroke.

## **UNIT VI Yoga, Physical Exercises and Fitness**

Meaning, Definition and Uses of Yoga - Essentials of Yogic Practices - Eight limbs of Yoga - Methods and Benefits of selected Asanas and Pranayama - Physical Exercises, Types: Aerobic, Anaerobic, Effects of Physical Exercises on various systems - Circulatory, Muscular, Digestive

and Respiratory systems - Difference between Physical Exercises and Yoga - Fitness components and its importance - Effect of Physical Exercises on human body systems.

### **UNIT VII Food and Nutrition**

Meaning of Food, Classification, Constituents of Food, Vitamins and Deficiency Diseases, Meaning of Nutrition, Malnutrition - Causes - Balanced Diet and Diet for Obesity and Under Weight.

### **MODE OF TRANSACTION**

Lecture, Discussion, Workshop, Practical Work etc.,

### **PRACTICUM**

- Preparation of first aid kit.
- First aid for road, water, fire accidents and athletic injuries
- Preventive measures for health hazards
- Yoga
- Demonstration of asanas and pranayama
- Power point presentations for a topic in the syllabus
- Playing Games
- Preparing a report of the achievements of eminent players
- Strategies for positive thinking and motivation

### **REFERENCES**

- Agarwal, Satya, P. (1998), The social role of the Gita: How and why, Motilal Banarsidass,
- Goel Devraj & Goel Chhaya (2013) Universe of Swami Vivekananda & Complete Wholistic
- Social Development, CASE Publication under UGC SAP, The M.S University of Baroda, Vadodara.
- Porter, Noah. (2003) Falung Gong in the United States: An Ethnographic Study, Master Thesis, Department of Anthropology, College of Arts and Sciences, University of South Florida.

- Dhanajoy, S., & Seema, K. (2007). Lesson planning: Teaching methods and class management in physical education. New Delhi: Khal Sahitya Kendra.
- Nash T.N. (2006). Health and physical education. Hyderabad: Nilkamal Publishers.
- Prasad, Y. V. (2006). Method of teaching physical education. New Delhi: Discovery Publishing house.
- Sachdeva, M. S. (2006). School organisation, administration and management. Ludhiana: Dandon Publication.
- Chandra, S., Sothi, & Krishnan.P. (2005). Health education and physical education. Delhi: Surject Publications.
- Mangal, S. K. (2005). Health and physical education. Ludhiana: Tandon Publication book market.
- Ajmer, S. (2003). Essentials of physical education. New Delhi: Kalyani Publishers.
- Tiwari, O. P. (2002). Asana : Why and how. India: Kanalyadhama.
- Hedge, (1997). How to maintain good health. New Delhi: UBPSD Publishers.
- Kanele., B. S., & Kumar, C. P. (1996). Text book on health and physical education. Ludhiana: Kalyana Publishers.
- Reema, K. (1996). Physical fitness. New Delhi: Khel Sahitya Sports Publication.
- Dambrosa, D., & Robert, D. (1993). Prevention and treatment and running injuries. New Jersey: Slack Incorpor Road.
- Krishna, G. (1993). The purpose of yoga. New Delhi: UBS Publishers Ltd.
- Ramachandran, L.T., & Dharmalingam. (1993). Health education. A new approach. New Delhi: Vikas Publishers Ltd.
- Charles, B. A. (1992). Foundation of physical education and sport. New Delhi: B1 Publication.
- Eriksson, O. B. (1990). Sports medicine, health and medication. Enfield: Guinness

## UNIT –I

### INTRODUCTION TO PHYSICAL EDUCATION

#### Structure

- 1.1 Introduction
- 1.2 Objectives
- 1.3 Physical Education-meaning
- 1.4 Definition of Education and Physical Education
- 1.5 Aims of physical education
- 1.6 Objectives of physical education
- 1.7 Scope of Physical Education
- 1.8 Importance of Physical Education
- 1.9 Physical fitness
- 1.10 Olympic movements
- 1.11 Modern Olympic games
- 1.12 Olympic-opening ceremony
- 1.13 Olympic flag
- 1.14 Winter Olympic games
- 1.15 Special Olympics
- 1.16 Marathon race
- 1.17 Ancient and Modern Olympic games
- 1.18 Recreational Activities
- 1.19 Let us sum up
- 1.20 Unit end activities
- 1.21 Answer to check your progress
- 1.22 Suggested Readings

## **1.1 Introduction**

‘A sound mind is in a sound body in a sound environment.’ Every person must possess a healthy mind: to have a healthy mind one must have a healthy physique. Healthy persons could alone make a healthy society. Physical Education may provide the right direction and needed actions to improve the health of members of any community, society, nation and the world too. Therefore an educational system encompassing the mental, emotional, social and physical dimensions of health becomes imperative to bring about all around development in children which, in turn, would pave way for the development of healthy society.

## **1.2 Objectives**

After learning this unit, you will be able to:

- Describe the meaning, aims and objectives of physical education
- State the scope of and importance of physical education
- Know the concept of Olympic games-events and awards
- Understand the Ancient and modern Olympic games
- Identify the rules and conduct of Olympic games
- Use the various recreational activities

## **1.3 Physical Education -Meaning**

The word physical education comprises of two words Physical and Education. The plain dictionary meaning of word physical as relating to body characteristics of a person such as physical strength, physical endurance, physical fitness physical appearance or physical health. The word education may mean the systematic instructions or training or preparation for some particular task. The two words combined together stands for the systematic instructions or training related to physical activities or programme of activities necessary for development and maintenance of human body or the development of physical powers or activities for cultivating physical skills.



#### **1.4 Definition of Education and Physical Education**

- ‘Education is the manifestation of perfection already in man’. –**Vivekananda**
- ‘By Education I mean an all round drawing out of the best in child and man, body, mind and spirit.’ – **M.K.Gandhi**
- ‘Physical Education is education through physical activities to the development of total personality of the child and its fulfilment and perfection in body mind and spirit.’- **J.P.Thomas**
- ‘Physical education is the sum of the changes in the individual caused by experiences centering motor activity’ –**Cassidy**

#### **1.5 Aims of Physical Education**

The aim of Physical Education is the same as that of general education, because physical education is a part of general education. The primary aim of physical education is not to develop star athletes winning teams or expert performance but a national vitality with character values and physical fitness. Ministry of Education National plan of physical education and recreation expressed that the aim of physical education must be to make every child physically, mentally and emotionally fit and also to develop in him such personal and social qualities as will help him to live happily with others and build him up as a good citizen.

Butcher listed the aims of physical education as follows:

- (i) Physical development
- (ii) Mental balance
- (iii) Emotional adjustment
- (iv) Manual training
- (v) Social adaptability

## 1.6 Objective of Physical Education

The objectives of physical education are stated differently by many of Physical Educationists. The following are main objectives of physical education.

**Development of Organic Fitness:** This objectives deals with the program of activities which builds physical power in and individual through the development of the various organic systems of the body. The systems such a circulatory system, respiratory system, nervous system, muscular system and digestive systems. Physical education is related to physical activities, which create various effects on our organic systems. These systems are developed in size, shape, efficiency etc. This promotes a sound health, which enables the individual to be the valuable asset for the nation. If our systems remain in sound health, they can perform their functions in an efficiency way.

**Development of Mental health:** The mental development objective deals with the accumulation of a body of knowledge and the ability to think and to interpret their knowledge. Physical education programmers need alertness of mind, deep concentration and calculated movements. Physical activities sharpen the mind, to perform various activities. It includes rules and regulations techniques of games, anatomical and physiological studies balanced diet, sanitation, health and diseases personal hygiene etc. Through participation in various activities an individual learns to draw certain conclusions. He is able to understand the new situations faced in the games. He is able to take decisions independently.

**Social Development:** In the democratic society in which we live it is necessary to have all individual develop sense of group consciousness and cooperative living. Social traits are essential for better adjustment in life. The programme of physical education develops these traits. They provide leadership qualities. Through physical activities, the players come closer with each other and adjust themselves according to situations. It helps in attaining the traits like cooperation courtesy fair play, sportsmanship self control unselfishness tolerance and sympathy.

**Development of Neuro muscular co-ordination:** The nervous system is strengthened only proper physical exercise. neuro muscular coordination develops well only of various of exercises are done repeated for a long period of time. Good neuro muscular coordination helps to keep off fatigue coordination. We get accuracy and smooth function of our body. Our reaction time

becomes less. Neuro muscular development helps ones be perform the daily work with proficiency develops a well poised quick and efficient movement and body graceful carriage.

### **Development of Desirable habits**

- To be inculcated regular activities rest regulated diet
- Maintaining cleanliness
- To be disciplined in one's work
- Chalking out a schedule of desirable activities that may contribute towards a healthy body and a happy mind

### **Development of Personality**

- Attainment of sportsmanship
- Development of leadership qualities
- Development of social cooperation
- Development of fearlessness
- Attainment of positive qualities of self confidence
- Attainment of self control

### **Providing for Mental Hygiene**

- Mental Hygiene comprises those activities and techniques which promote and maintain mental health.
- Development of ability to face stresses and string of like
- Elimination of worry and tension through games and sports

### **Development of Functional Knowledge**

- To know the rules and techniques of different games
- To know and acquire knowledge, proper health procedure
- To know the methods and principles of games and exercises
- To know the body parts and the effects of exercise on various organs and systems.

### **Development of qualities of a good citizenship**

- One has to abide rules and regulation
- One's discipline improves the qualities of a good citizenship

### **1.7 Scope of Physical Education**

Physical Education as an integral part of general educa- through activity oriented and well planned programmes they organize different physical activities like drill and marching etc which are directed towards physical, mental emotional, social, intellectual and moral development of the child. The following are the scope of physical education.

- 1. Corrective Exercises:** Corrective exercises help to remove the deformities in the body of a child. Sometimes these defects are there because of defects in muscle development and for the we use light corrective exercises
- 2. Games and Sports:** various team games like hockey foot ball, cricket basketball and volley ball etc and individual events like athletics, wrestling, boxing judo and archy are included in the programmers of physical education. Swimming, diving, canoeing etc are related to water sports.
- 3. Rhythmics:** Gymamstics, Leziiums Dance, mass physical training and Dumb bell etc. are rhythmical activities necessary for rhythm and balance. Rhythmical activities are also included in the programmes of physical education.
- 4. Self defense activities:** Hiking, Trekking, Judo, karate and self defense activities are included in the programmes of physical education.

5. **Recreational activities:** Recreational activities like minor games, chess, carom, horse riding, education campus, hunting, folk dance, fishing etc are included in the programems of physical education.
6. **Yogic activities:** Yogic activities such as Asana Pranayama Kiryas etc are included in Physical education.

On the basis of the above mentioned facts, the following activites can be included in a programme of physical education India:

1. Free hand exercises
2. Exercises with apparatus
3. Major games
4. Minor games
5. Gymnastics
6. Track and field events
7. Folk dances
8. Yoga
9. Rhythmics
10. Combatives
11. Swimming and diving
12. Hiking trekking comping etc
13. Pyramids
14. Dands and baithaks

## **1.8 Importance of Physical Education**

- Physical education develops the alertness of mind
- Physical education provides knowledge about health and its hazards and communicable and non communicable diseases
- Through physical activities leisure time can be utilized properly
- Through physical education human body can be developed in good proportion. The physical beauty also improves
- A good sports man is a good citizens He knows how to adjust with others
- Physical education helps in developing and maintaining of good relations among humans beings. It develops social traits, like cooperation, sympathy, loyalty, fraternity, courtesy and other traits of leadership.
- Aggressiveness can be eliminated through physical activities. By participating physical activities we can overcome stress tension and sensitiveness
- Physical education helps in creating discipline through games and sports
- Physical education provides a numbers of opportunities to enhance the power of tolerance
- Physical education enhances all the essential traits required for development of the personality
- Physical education leads to happiness efficiency and character building
- Physical education helps the people to become fit to develop their spiritual and more forces. It increases the scope of human abilities and enriches the life of the individual and that of the society as a whole.

### **Check your progress**

**Notes : a)Write your answer in the space given below**

**b)Compare your answer with the those given at the end of the unit**

1. Physical education refers.....

a) Physical strength b)Mental ability c)Emotionally stable d )All the above ( )

2. Chess and carom belong to which kind of activity ?

a) Rhythmics b)Self defence c)Recreational d )Yogic activities ( )

## **1.9 PHYSICAL FITNESS**

### **Meaning of Physical Fitness**

Physical fitness implies abilities such as that of resisting fatigue, performing with an acceptable degree of motor ability and being able to adapt to muscular stress. Physical fitness can also be functional specific and emergency requirements

### **Definitions**

Physical fitness refers to the organic capacity of the individual to perform normal task of daily living without undue tiredness or fatigue having reserves of strength and energy available to meet satisfactory and emergency demands suddenly placed upon him”.- *Nixon*

Physically fitness is the quality of the whole body in terms of its state of adaptation of physical activity.

### **Components of Physical Fitness**

Physical fitness can be the most easily understood by examining these components, or elements or parts. There is widespread agreement that following four elements are basic.

**1. Endurance:** The ability to deliver oxygen and to tissues and to remove wastes over sustained periods of time. Long runs and swims are the methods employed in measuring this component.

**2. Strength:** The ability of a muscle to exert force for a brief period of time. For example, upper body strength can be measured by various weight lifting exercises.

**3. Speed:** The quickness of movement of a limb, whether this is the leg of a runner or the arm of the shot putter.

**4. Flexibility:** The ability to move joints and use muscles through their full range of motion. The sit and reach test is a good measure of flexibility of the lower back and back of the upper leg.

Body composition is also considered a component of fitness. It refers to the makeup of the body in terms of lean mass (muscle, bone, vital tissue and organs) and fat mass. An optimization of fat to lean mass is an indication of fitness and the right of exercise will help one to decrease body fat and increase and maintain muscle mass.

### **Benefits of Physical Fitness**

Exercise or fitness is not just for Olympic hopefuls or supermodels. In fact, no one is ever too unfit, too young, or too old to get started. Regardless of age, gender, or role in life, one can benefit from regular physical activity. If there is a commitment to exercise in combination with a sensible diet, it can help to provide an overall sense of well-being and can even help to prevent chronic illness, disability, and premature death. Some of the benefits of increased physical activity or physical fitness are:

#### **Improved health**

- Increased efficiency of heart and lungs
- Reduced cholesterol levels
- Increased muscle strength
- Reduced blood pressure
- Reduced risk of major illness such as diabetes and heart disease



- Weight loss

### **Improved Sense of well being**

- More energy
- Less energy
- Improved quality of sleep
- Improved ability to cope with stress
- Increased mental sharpness

### **Medicines**

- |                          |                          |
|--------------------------|--------------------------|
| • Smelling salt          | • Cum paint              |
| • Common salt            | • Johnson Violet         |
| • Burnol                 | • Glycerin               |
| • Dettol                 | • Dusting powder         |
| • Iodex                  | • Caromin drops          |
| • APC                    | • Vicks vapourub or balm |
| • Potassium Permanganate | • Bicarbonate of soda    |
| • Belladonna Plaster     | • Olive oil              |
| • Tincture of Iodine     |                          |

### **Check your progress**

**Notes : a)Write your answer in the space given below**

**b)Compare your answer with the those given at the end of the unit**

3. Improved health includes...

- a) Reduced cholesterol level b)Increased muscle strength c)Reduced blood pressure  
d )All the above ( )

4.Find out the best components of physical fitness

- a) Endurance b)Strength c)Speed d )Flexibility ( )

## **1.10 OLYMPIC MOVEMENTS**

### **Olympic Games**

Olympic Games is an international sports event in which intercontinental and international competitors participate in the sports competitions. Participation in sports help the peoples to know one another and also it provides opportunities to the participant to see each other

It unites countries and continents. The Olympic movement like sport in general by its very nature brings in international understanding and opposes the division of the world, rapprochement and friendship among people of all continents.

### **Objectives of Olympic Games**

1. To develop interest and competence of life time participation in games and sports and for that purpose.
  - To develop physical and motor fitness i.e strength, endurance speed agility, flexibility balance, accuracy etc.
  - To develop good body mechanics and skills in a variety of dynamic forms of movements applied in games and sports
  - To develop a fir level of skills to specific major games and track and field events  
Gymnastics and yoga exercises
2. To develop interest for games and sports as a cultural heritage
3. To develop social aim.
4. To develop social qualities such as cooperation sympathy team spirit, helpfulness, tolerance, patience and sportsmanship.
5. To develop emotional maturity mental alertness and moral goodness
6. To develop Psycho somatic unity i.e. unity of the mind and body

7. To develop motor skills i.e Neuromuscular coordination

### **Ancient Olympic Games**

The Olympic Games were held once in four years on the full moon day in the month of August or September at Olympia in Greece in honour of their God Zeus. We cannot definitely state the origin of these games, but these are a few legends which show that these games were in existence from very remote times.

### **Origin**

1. It was believed by the Greeks that there was a wrestling contest between God Zeus and God Kronos for the Possession of Earth. In the contest God Zeus won and in remembrance of the victory of Zeus, the Olympic Games were started.
2. Hercules it is said defeated King Augeas and in honour of his victory he instituted the Olympic games (Circa 1253 B.C)
3. Peleus won over king Aenomanus in a chariot race and married the latter's daughter Hippodemia. As king Aenomaus died in the race itself. Peleus took his kingdom. Peleus was worshipped as a hero and in his death the Olympic games instituted (884B.C)
4. Another version states that Lycurgus, the Great Sparta law giver joined hands with Iphitus of Elis to restore the Olympic festival in 820 B.C. The version indicates that the games had been run before.

Thus these legends clearly show that the Olympic Games had a long past

Although the origin of the Olympic games is lost in legend and obscurity the year 776 B.C. was reckoned and recorded as the date of the first ancient Olympics thanks to the efforts taken by Cleosthenes (King of Pisa) and Iphitus (King of Elis) who became weary of the war over the control of Olympia made a sacred truce and revived the ancient Olympic festival.

The winner of the first Ancient Olympics in 776 B.C. was Coroebus. From this date onwards the games were held regularly once in four years until 394 A.D. when the games were abolished by the Roman emperor Theodosius I.

## **Rules Eligibility for Competition**

- i. The participants should be free born Greeks
- ii. The amateurs were allowed to participate
- iii. The competition must have had at least 10 months of training prior to their participation in the Olympics the final month being spend at Olympia under the control of the Hellanodikai the official judges of the games.
- iv. They should have no criminal record

## **Conduct of the Games**

Assembly: Before the start of the games the competitors their trainers their fathers their brothers and the judges assembled in the council house in front of the state of Zesus (God of oaths)

### **Sacrifice: Sacrificed a pig to Zesus**

Oath: All took an oath that they would not resort to any unfair means to secure victory further the competitions took the oath that they had 10 months of training as per Olympic regulations. Thereafter the Olympic judges swore that they would be honest and fait in their decisions

March Past: The march past took place in which the Trumpeter Officials and the competitors participated. In the courts of the March past as the competitors passed by the Herald announced to the spectators the name of each competitor his father's name and his city and asked whether anyone had any charge to make against him. Silence on the part of the specifications was considered as No Objection for the competitor concerned.

Opening Ceremony: Then the herald proclaimed the opening of the games. The chief judge or some distinguished person addressed the participants. Afterwards the events were conducted the sacred fire was kept burning perpetually at the altar of Zesus.

## **Events**

Originally foot race was the only item in Ancient Olympics and it was conducted in single day. Later on other events were added and they were foot race, chariot race, horse race, pentathlon (Running, long jump, discus throw, javelin throw and wrestling) Boxing Wrestling, pancratium etc. Because of the addition of more events from time to time, the duration of the games was extended to 5 days.

The first day was devoted to religious sacrifice and oath taking and no Competitions were held.

On the second day there was a march past, the introduction of the competitions to the public and the opening of the games. This was followed by chariot race horse race and pentathlon.

The third day was the day of official sacrifice of a 100 oxen in the morning at the Altar of Zeus. In the afternoon footrace; wrestling and boxing were conducted for the boys.

The fourth day was reserved mainly for the chief athletic events for men via three foot race and the dual combats (Wrestling, boxing and pancratium). The day's programs would come to an end with the race in armour.

The fifth day was the last day which intended only for feasting and rejoicing

Originally women were not allowed to compete in the Olympics and the married women were not even allowed to witness the competitions. It is understood that women had their own festival called the heraca in honour of her, wife of God Zeus. In this festival women had athletic competitions. Later on women were allowed to compete in the Olympics in the Chariot race.

## **Awards**

- The Olympic victor was highly honoured. It seems that tripods and other valuable objects were given as prizes to the Olympic victor till the 7<sup>th</sup> Olympiad.

- Later on the only reward from the judges at the Olympic stadium was a wreath made out of Olive leaves plucked from the sacred Olive tree in the temple of Zeus.
- Poets immortalized his name in poems and sculptors carved his figure in stones. The concerned Olympiad was named after the name of the victor of the state race i.e. 200 yards race.
- The winners were escorted home in triumph by their fellowmen and loaded with honour, gifts and privileges. We even come to know that they were received in their cities not through the ordinary gates but through a breach made in the walls of the city. They were even considered as demigods. To be crowned a victory in the Olympics was the highest honour to every Greek.

### **1.11 Modern Olympic Games**

#### **(From 1896 AD onwards)**

For nearly 1500 years since 394 A.D. there were no Olympics. The first efforts towards renaissance of the Olympics in modern times were made by the Greeks in 1859 and 1870. The Greeks and Evangelos Zappas a Greek living in Rumania, began working towards the revival of the Olympics long before Coubertin the Frenchman succeeded. Two Olympic games organised by the Greeks in 1859 and 1870 were unsuccessful. In 1894 A.D.

Baron Pierre De Coubertin a Frenchman revived the Olympic games. He felt that international unity and brotherhood can be achieved through competitions in sport and games among the youth of the various countries at one place similar to the ancient Olympic Games. He visited various countries and put forth his ideas. His ideas were welcomed and it was decided to hold the first Olympics in Greece. As the ancient site at Olympia was not suitable to conduct the games. Athens in Greece was selected.

The sponsors of the Modern Olympics were hard pressed for money. The Greek Government gave about 2 ½ lakhs of drachmae in addition to the money bequeathed by Zappas. Even this amount was not enough. Fortunately one George Averoff a merchant of Alexandria gave a princely gift of million drachmae for restoring the Pan Athenian stadium and conducting the games.

Modern Olympics is held once in four years But during the times of world wars, the Olympic games (i.e VI, XII and XIII Olympiads respectively in the years 1916, 1940 and 1944) were and held in the days of Ancient Olympics such sanctity was attached to the games that wars were stopped for the conduct of the Olympics whereas in the days of Modern Olympics. We have witnessed that Olympic Games had to be stopped for the conduct of the wars.

### **Governing Body**

1. The international Olympic Committee is the controlling body for the Modern Olympic Games. The I.O.C. is a permanent and self elected body which has at least one member from a country where there is a National Olympic committee.
2. The members shall elect a president for eight years and he is eligible for reelection
3. Two Vice presidents shall also be elected for a period of four years who are also eligible for reelection
4. A small Executive board shall be formed which shall include the president the two Vice presidents and four other members elected for a period of 4 years who shall retire by rotation
5. The I.O.C fixes the venue for competition draws the rules for competition draws the rules for competition and the general programme for Olympics

### **Rules of Eligibility of Competition**

1. One who is a native or naturalized subject of a member country can alone participate
2. One who has competed already in the Olympic games for a nation cannot compete in future Olympic games for another nation even if he has become a naturalized subject of that nation except in the case of conquest or the creation of a new state ratified by a treaty.
3. Every competitor must be an amateur This must be certified by the national body controlled that activity and countersigned by the National Olympic committee. In addition each competitor must give a personal declaration that he is an amateur.
4. There is no age limit for a competitor.

## **Organization and conduct of the Games**

The Olympic Games should be held in the first years of the Olympiad. The games under no pretext can be adjourned to another year. The period of the games shall not exceed 16 days

### **Venue**

The venue for the Olympic competitions will be fixed by a majority of votes among the members of the international Olympic committee, taking into consideration the claims made by the cities opting to stage the games. Committee from the I.O.C and the respective NOC's (National Olympic Committees) along with the respective international sports federations visits the cities aspiring to hold the games to determine its suitability.

After various committees submit their respective reports to the IOC it takes the final decision through a ballot at a session held in a country, no city of which was a candidate. The selection unless in exceptional circumstances, is made at least six years in advances.

When the venue is fixed the mayor of that city will be informed about the decision of IOC. The Mayor in turn will inform the National Olympic Committee and this committee will take up the responsibility of Organizing and conducting the games.

### **Events**

The events are fixed by the organizing committee in consultation with international Olympic Committee. The usual events are track and field sports, Gymnastics, Boxing, Fencing Wrestling Shooting, Rowing Swimming and Diving Equestrian Sports (Horse riding) Football, water polo, Hockey, Cycling, Weightlifting yachting (Sailing, Ship racing) Basket ball, Volleyball etc.

#### **1.12 Olympic -Opening Ceremony**

1. For opening of the games, usually the President, King or any other head of the State will be asked to preside and declare the games open. The president will then mount up the Tribune of Honour and the National Anthem of the host country will be played.



2. The march past of the athletes and the officials will take place according to the alphabetical order of the countries. In the march past the Greek contingent will always take the lead while the host country will be at the end.
3. The president of the games will declare open the Olympiad of the modern era
4. Hoisting of the Olympic flag with fanfare of trumpets followed by a salute of gun fire and pigeons release
5. The Olympic torch will be brought into the stadium and the Olympic flames will be lit in the bowl constructed for this purpose. The flames will be burning throughout the period of the Olympic Games.
6. All the bearers will move forward to the Rostrum and stand in a semi circular fashion facing the Tribune of Honour.
7. The Olympic oath will be taken by a representative of the athletes usually an athlete of the host country who will take the following oath.

The Olympic oath will be taken by a representative of the athletes usually an athlete of the host country who will take the following oath.

We swear that we will take part in the Olympic games in loyal competition respecting the regulations which govern them and desirous of participating in them in the true spirit of sportsmanship for the honour of our country and for the glory of sports

Presently this oath has been revised a sunder and given effect from Sydney Olympics 2002.

In the name of all competitors I promise that we shall take part in this Olympic game respecting and abiding by the rules which govern them without the use of doping and drugs in the true spirit of sportsmanship for the glory of sports and the honour of our teams.

After the Oath the National Anthem of the host country will be played. The athletes and the Officials shall march out of the stadium. The games shall then begin.

## **Awards**

Those who get the first three places will mount the Victory stand. The first place winner will be at the centre at a higher level.

The second place winners will be on his right and the third place winners on his left. As soon as they have mounted the victory stand the national flags of the winners will go up the masts. The National Anthem of the winner will be briefly played.

The victors will be crowned with Olive Wreaths. The President of the International Olympic committee or his representatives will give away medals and diplomas (Gold Medal for I place, Silver Medal for II place and Bronze medal for III place)

The banes of the victors will be inscribed on the walls of the stadium where the Olympics games are conducted. In addition a Roll of honour is kept with the international Olympic Committee in which the names of the first six competitions are entered. Competitors who have secured IV, V and VI places in each event are awarded only Diplomas. Souvenir medals are given to all participants.

## **Closing of the Games**

The closing of the games will take place in a solemn manner. The president of the International Olympic Committee will express his gratitude to the organizers. He will then declare the games closed and will call upon the youth of the various countries to assemble again after four years at the next venue of the games.

Immediately after his declaration the ceremonial Olympic flag (not the one that was hoisted on the flag mast) will be handed over to the Mayor of the city, so that he can keep the flag safely till the next Olympic Games. Then trumpets will be sounded, the Olympic flames will be extinguished and the Olympic flag will be lowered. Thus the games come to a close.

### **1.13 Olympic Flag**

There are two kinds of flags used by the International Olympics Committee

1. Olympic flag for hoisting purpose during Olympic

## 2. Ceremonial Olympic flag

### (i) Olympic flag

# The Olympic Flag

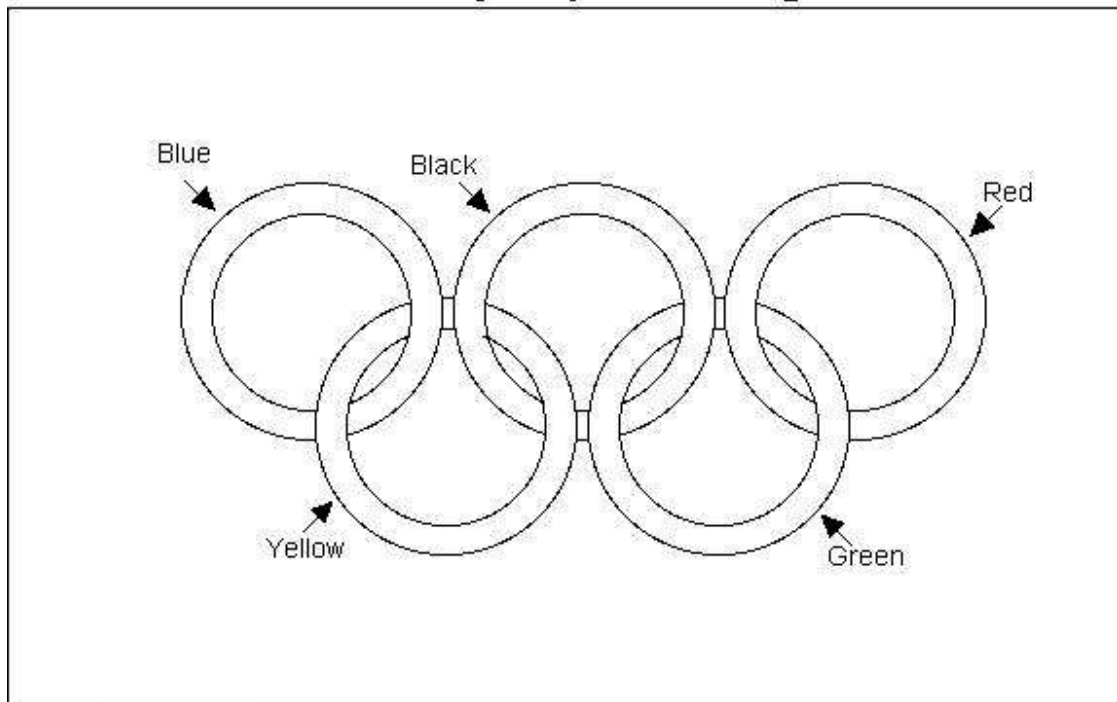

1. This Olympic flag is based on a model design by Baron de Coubertin in 1914. It was first hoisted in 1920 at Antwerp (Belgium) Olympics.
2. The Olympic flag is made of white silk without any borders. In the centre, there are five interlocking rings in the colours of Blue, Yellow, Black, Green and Red representing the five continents viz. America, Asia, Africa, Europe and Australia.
3. The five rings are arranged in the shape of a W.
4. The blue ring shall be high on the left nearer the flag pole.
5. Below the rings appears the Olympic Motto *Citius Altius Fortius* which means ever faster, higher, stronger.

6. Those rings together with the motto constitute the Olympic emblem which is the exclusive property of the International Olympic committee.
7. Only the flag is hoisted during the Olympic Games

**(ii) Ceremonial Olympic flag**

- a. This flag is made of silk and this is bordered with the colours of the rings (blue , yellow, black, green and red)
- b. This flag is not intended for hoisting purpose
- c. The flag is handed over to the Mayor of the city conducting the concerned Olympics by the president of I.O.C at the time of the closing ceremony. This shall be under the custody of the Mayor of the city till the next Olympics

**Motto of the modern Olympic games**

The Olympic Games had come to stay in 1897. The international Olympic games committee adopted a Dominican monks words. Citius Aitius, Fortius Ever (fastest, highest, strongest) as the Olympic motto to embody the spirit of the games.

The most important thing in the game is not to win but to take part just as the most important thing in life is not the triumph but the struggle. The essential thing is not to have conquered but to have fought well.

**Olympic Torch**

The ritual flame lighting ceremony takes place at the temples of Hera, near the stadium where the ancient Olympics were held. An actress from the Greek national theatre, portraying a priest-ess , uses a concave mirror to catch the sun's rays to ignite the torch which is then handed over to young athletes who carry it for one kilometer each (if it has to be flown, the flame is kept in specially made lanterns while it is being transported to the host nation).

This torch shall then be relayed on foot (as far as possible) by runners until it is finally taken to the city where the games are to be conducted.

On its way as it passes through various countries the particular country through which it passes shall arrange for the relay of runners to bear the torch. The last runners shall be an athlete from the host country and his arrival with the torch will be synchronized with the opening of the games.

This was first initiated by the Germans while they organised the Berlin Olympic Games in the year 1936. From Berlin Olympic onwards this practice is continued. Now a day's torch is also carried in aero planes from one country to another where it is not possible to carry it by a relay of runners.

#### **1.14 Winter Olympic Games**

The Winter Olympic Games were first introduced in the year 1924 these are also held once in four years in the same year of the Olympics but not at the same time. Hence there is a distinct cycle of winter games. This Olympics is held at the places where the geographical and climatic conditions will be conducive of the conduct of these games. The events where the geographical and climatic conditions will be conducive for the conduct of these games. The events for the competitions are Ice Hockey, Skating, and Skiing etc.

#### **1.15 Special Olympics**

Special Olympics is an international organization dedicated to empowering individuals with mental retardation to become physically fit, productive and respected members of society through sports training and competition. Special Olympics offers children and adults with mental retardation year round training and competition in 26 Olympic type summer and winter sports. To be eligible to participate in Special Olympics they must be at least eight years old and identified by an agency or professional as having one of the following conditions.

Mental retardation cognitive delays as measured by formal assessment or significant learning or vocational problems due to cognitive delay that require or have required specially designed instruction. It does not cost anything to participate. The special Olympics world summer games are held every four years and the special Olympics world winter games also are held every four years.

### 1.16 The Marathon Race

The Marathon Race was first introduced in 1876 at the first modern Olympic games in Athens. The inclusion of this great dramatic and spectacular event in the modern Olympics was mainly due to the initiative and efforts taken by a Frenchman by name Michael Breal who was one of the delegates of the congress which initiated the Modern Olympics. He also instituted a trophy for this race.

This race was introduced in order to commemorate the explore a famous Athenian runner by name Pheidippides. In 490 B.C the Persians invaded Greece and fought with the Greeks at the battle field of Marathon. In that battle the Persians were defeated and the Greek commander Miltiades wanted to convey that glad news to Athens. He therefore called for Pheidippides, the famous Athenian runner and asked him to run all the way to Athens and communicate the news to the anxious city fathers

Pheidippides had fought in the battle that day as a soldier Although he was tired he obeyed the orders of his commander and ran all the way from marathon to Athens a distance of about 18 leagues (i.e about 27 miles) H1 was he fell down dead.

The perpetuate his memory the Marathon race was introduced in the Modern Olympics.

The distance for the race was fixed finally in 1908 at the London Olympic games. The distance is 26 miles and 385 yards (42.195 meters)

Olympiad	Year	City	Country
1.	1896	Althens	Greece
2.	1900	Paris	France
3.	1904	St.Louis	USA
4.	1908	London	England
5.	1912	Stockholm	Sweden
6.	1916	Berlin	Germany
7.	1920	Antwerp	Belgium

8.	1924	Paris	France
9.	1928	Amsterdam	Holland
10.	1932	Los Angeles	USA
11.	1936	Berlin	Germany
12.	1940	Tokya	Japan
13.	1944	Rome	Italy
14.	1948	London	England
15.	1952	Helsinki	Finland
16.	1956	Melbourne	Australia
17.	1960	Rome	Italy
18.	1964	Tokyo	Japan
19.	1968	Mexico	America
20.	1972	Munich	Germany
21.	1976	Montreal	Canada
22.	1980	Moscow	USSR
23.	1984	Los Angeles	USA
24.	1988	Seoul	South Korea
25.	1992	Barcelona	Spain
26.	1996	Atlanta	USA
27.	2000	Sydney	Australia
28.	2004	Athens	Greece
29.	2008	Beijing	China
30.	2012	London	England

### 1.17 Ancient And modern Olympics (Comparison)

S.No	Ancient Olympics	Modern Olympics
1.	The ancient Olympics were conducted once in four years	The modern Olympics are conducted once in four years
2.	There was the march past of the participants	There is the march past of the participants
3.	In ancient Olympics Oath was taken by all competitors	In modern Olympics a leading Athlete of the Host country takes the oath on behalf of the competitors of all nations at the Olympics stadium in front of the Tribune of honour
4.	The competitors who wished to participate in ancient Olympics must be free born Greeks. They should have neither committed any sacrilege against gods nor have any criminal record	The competitors who wish to participate in modern Olympics shall be the natives or naturalized subjects of a member country
5.	Only Amateurs were allowed to participate	Only Amateurs are allowed to participate
6.	The ancient Olympics were held only at Olympia in Greece	The modern Olympics are not held at Olympia but at different cities of the world
7.	In the earlier Olympics married women were not allowed even to witness the games and later on they were allowed not only to witness but also to participate in the games	In the modern Olympics women were allowed to take part from 1900 onwards
8.	In the earlier Olympics men and boys participated in competitions in naked form	In modern Olympics competitor have to wear a decent sports costume
9.	The ancient Olympic games were a religious festival for the Greeks being held in honour God Zeus	The modern Olympic games are an international sports gathering with a zeal of patriotism
10.	Sacred fires were burning perpetually in the temple of God Zeus at Olympics	The Olympic fire is lit and kept burning at the stadium till the close of the games



11.	In ancient times the Olympic games were held to maintain unity among Greeks	In modern times the Olympic games are held for the international understanding and brother hood
12.	Ancient Olympics were conducted for 5 days	Modern Olympics are conducted for 16 days
13.	In ancient Olympics the items were individualistic	In modern Olympics both individual and team events are conducted
14.	In Ancient Olympics the victors were crowned with sacred olive wreaths. The poets immortalized their names in poems and sculptors made statues for them	In present days the victors are normally crowned with olive wreaths. They are awarded medals and diplomas. Their names are inscribed of the walls of the stadium. A roll of honour or the first six competitors in each event is kept with the I.O.C
15.	Each Olympiad was named after the victor of the strade race. For example the Corbus Olympiad (from 776 BC to 772 BC) was named after corneous the winner of the strade race in 776 B.C.	Each Olympics is called in its serial order. For examples XIV Olympiad (1948 to 1952) XV Olympiad(1952-1956)etc.
16.	Wars were stopped for the conduct of ancient Olympic games	Games has to be stopped because of wars

### 1.18 Recreational Activities

These consist of a variety of minor games lead up games, story plays, simple status and combats relays etc No lesson is complete without recreative activities because they not only develop the natural skills but would also provide fun pleasure and enjoyment to the participants.

### **Check your progress**

Notes : a) Write your answer in the space given below

b) Compare your answer with the those given at the  
end of the unit

5. List out the eligibility of competition in the Olympic games.

### **1.19 Let us sum up**

The present unit attempts to provide a basic understanding of physical education with the detailed concept of Olympic Games. This unit also discusses the comparison of Ancient and modern Olympic games

### **1.20 Unit ended activities**

1. Identify the content related activities for achieving the objective of providing physical education at the training level.
2. Chose a content from the standard you are teaching –plan 2-3 consecutive session for insisting the importance of physical education

### **1.21 Answers to check your progress**

1. d
2. c
3. d
4. a
5. Refer the course material

### **1.22 Suggested readings**

1. Bucher Charles. A. "Foundations of Physical education" 8<sup>th</sup> Rd., The C.V. Mosby Co. St. Louis, 1979.
2. Dash. B.N "Health and Physical education", Newdelhi, Neelkamal publications, 2007.
3. Nanda V.K. "Health education", Anmol publications Pvt. Ltd. New delhi, 1997 .

## **UNIT-II**

### **Methods, Organization and Administration**

#### **Structure**

- 2.1 Introduction
- 2.2 Objectives
- 2.3 Methods of teaching physical activities
- 2.4 Teaching methods in physical education
- 2.5 Lesson plan
- 2.6 Intramural competition
- 2.7 Extramural competition
- 2.8 Tournament
- 2.9 Drawing Fixtures
- 2.10 Rules and Regulations of games
- 2.11 Let us sum up
- 2.12 Unit end activities
- 2.13 Answers to check your progress
- 2.14 Suggested Readings

## **2.1 Introduction**

Methods, organization and administration methods of teaching physical activities- parts and preparation of general lesson plan- Fixtures: single knock out and single league organization of an athletic meet-hangout, Basic bail- Rules and Regulation of Badminton, Cricket, Football, Hockey, Kabbadi and Volley ball-organization of intramural and extra mural competitions and tournament.

## **2.2 Objectives**

After learning this unit, you will be able to:

- Use the various methods in teaching physical science
- Understand and able to write a lesson plan with proper components
- Know the concept of Intramural and Extramural competition
- Describe the rules and regulations of the games such as Ball badminton, Khabadi and volley ball

## **2.3 METHODS OF TEACHING PHYSICAL ACTIVITIES**

Good teachers know what to teach, how to teach and understand the need of their wards. In addition, they are able to communicate effectively, can plan for and organize classes efficiently and have a deep commitment to the optimal development of the pupil.

## **2.4 TEACHING METHODS IN PHYSICAL EDUCATION**

Teaching methods may generally be classified into two areas: methods that are teacher centered and methods that are student-centered. However, the organization of classes for optimum learning is managerial in nature.

The following are few methods of teaching of physical education:

### **1. Command Method:**

In this method, learning-process is completely dominated by the teacher. The teacher's role is all pervasive and student's role is limited to obedience only. This method is useful in teaching drill, marching, set drills such dumbbells, hoops, wands, poles, mass drills, control of general assemblies, rallies and parades.

## **2. Lecture Method**

Class room corollary of the command style is known as the lecture style. But it allows adequate opportunities to the pupils to ask/probe questions. Inspection of teacher continues to have full control of the class-room atmosphere.

## **3. Demonstration Method**

Demonstration method is based on the theory of learning by imitation. A perfect demonstration of an activity or skill catalyzes mental processes and serves as a model for its practice.

## **4. Task/Project Method**

In this method, a physical-education task is selected, a proposal is presented by the teacher to a student, the specific assignment is agreed upon and the task is completed. The students' then receive a previously prescribed level of credit.

The task assigned may be a trip in the mountains, running a given distance in a specified time, attaining a certain score on the pentathlon or decathlon, demonstration on agreed level of fitness, organizing a picnic, organizing a short/long duration camp, organizing athletic meet or writing on a specific project.

## **5. Reciprocal Method**

In this method, one student acts as the performer while another student evaluates his/her performance as the teacher.

## **6. Circuit Method**

In this method, a class is divided into various groups and each learner has to perform a functional role. The circuit method which can be applied to many activities consisting of a number of stations arranged in a circuit. At each station, the participant performs the required task. A circuit may be set-up in a gymnasium or in many other facilities. At each station, directions are provided for describing the task and indicating the next step. This method has been used extensively for weight-training, physical fitness programmes and for the administration of tests, but it may also be used for daily class-work as well.

## **7. Discussion Method**

Discussion method is the most democratic style of teaching, which is useful for the interpretation of rules and regulations of games, tactics and techniques of performance, game strategies and officiating.

## **8. Individual Programme Method**

In this method, there is an opportunity for self-motivated learning and decision-making over a more prolonged period of time. The chief objective of individual programme style is to make the pupils self-reliant in monitoring and assessing their own performance. Each student is required to learn a separate unit of subject matter with self-directed efforts.

## **9. Guided Discovery Method**

This style uses the process of inquiry to lead the students to the discovery of desired end-product. In this method, the teacher makes certain statements on few stimulating questions so as to present a clear background of the subject and to bring students to a common point of understanding.

## **10. Problem-solving Method**

This method provides maximum freedom of thought and action to the students. It encourages the students to make their own decisions in tackling problems. Each student is provided with a specific questions or task and is directed to seek out a variety of alternative solutions.

## **11. Felt- Need Method**

Reminiscent of the 'whole-part-whole' and traditional methods, this is commonly used in physical-education classes, especially where highly organized team games constitute the content. It consists essentially of the following steps.

1. The exposure of the pupils to the game by participation, by observing films, by watching the experts and by informal involvement outside the school.
2. The discovery by the pupils that better execution of fundamentals is needed to perform well and receive the most satisfaction from playing the game.
3. The return to some instruction and drill on the basics of the game.
4. Actually playing the game, as skills become increasingly automatic and execution becomes more perfect.
5. A constant return to fundamental drills to prevent deterioration in performance.

## **12. Co-Operative Method**

In this method, a high degree of interaction between the students and the teacher is observed and it requires a constant flow of information between the two and it will keep both

of them active. There are two variants in co-operative method, one is the movement practice and the other is discussion.

In movement practice, the movement is performed by the students for optimum number of times and is supervised/helped/supported/encouraged and corrected by the teacher.

The second variation of co-operative method is discussion. The discussion between the teacher and the taught are important means of education and motor learning. The discussions should be planned and interestingly organized by stimulating the students to actively participate in it. Discussions can be held at any time. After a training session, a short discussion of 10-15 minutes is always advisable.

### **13. Inductive Method**

This method is a combination of other teaching methods, where the task method is followed by presentation (demonstration, explanation and lecture) and co-operative method (movement and discussion)

### **14. Deductive Method**

In deductive method too, the other methods of teaching are arranged in a particular sequence, in which, presentation method is on the priority (demonstration, explanation, and lecture) followed by co-operative method (movement practice and discussion) and task method (observation, assignment, project etc.)

### **15. Whole Method**

In this method, the technique/skill are taught through demonstration and explanation and is practiced as a whole, where the learners are introduced with the movement/technique as a whole. It aims at the perception of the skill as a whole in terms of developing rough coordination i.e. the learner is able to do the complete movement but may be with several errors and mistakes.

### **16. Part Method**

In this method the technique/skill are taught, demonstrated, explained and practiced by part. This method start with the acquisition of fine co-operation i.e., the learner is able to do the movement nearly perfectly under normal conditions, but he/she is unable to do so under changed or difficult conditions. This method is characterized by high training volume, increased amount of movement correction and erratic progress in motor learning. The skill to

be learnt is divided in different parts and each is taught/learnt separately. Learning by this method results in the mastery on each part but lacks a joint/combined effort for performing the complete skill.

### **17. Part-Whole method**

In this method, the skill to be learnt is divided in different parts, each part is taught and learnt separately and afterwards all these parts are combined gradually to learn the skill completely.

### **18. Whole-Part-Whole Method**

In this method, the technique/skill is introduced by demonstrating and explaining it as a whole to the students in order to create and develop a rough image about the technique/skill and learnt by the students in the same manner. Then the skill is divided into different parts and each part is taught and learnt separately i.e. part by part. Here, the skill perceived as a whole, is practiced in different parts of difficult situations and are corrected at each level for perfection and detailed learning. Once again, the skill is performed as a whole with the purpose of achieving fine co-ordination, mastery of the technique and stabilization of movement execution under different and difficult situations. This method of teaching of physical activities is considered the best among all particularly for learning the most difficult technique/skill.

Teaching methods are really a way of organizing the class for instructions. However, a teacher may use any of these methods or combination of two or more methods according to their requirements for best teaching outcomes.

## **2.5 LESSON PLAN**

### **Definition of Planning**

According to L. Urwick, “planning is fundamentally a mental predisposition to things in an orderly way, to thing before acting and to act in the light of facts rather than to guesses”.

According to Koontz and O’Donnell, “Planning is an intellectual process, the conscious determination of course of action, the basing of decisions on purpose, facts and considered estimates”.



## **ELEMENTS OF GOOD LESSON PLAN**

1. A good lesson plan is usually a written statement.
2. In a good lesson plan, objectives are clearly stated.
3. The lesson plan is built on the apperceptive background of the class.
4. The material for instruction or subject matter is selected in an organized manner.
5. A good lesson plan indicates well selected and directed learning activities of students.
6. The plan indicated teaching techniques to be used by the teacher.
7. The plan indicates all apparatus that can be used for the particular period. i.e. charts diagrams, audio visual aids etc.
8. A good lesson plan provides an outline or summary of the whole lesson plan
9. A good lesson plan includes certain evaluation exercise, which may be in the form of recapitulatory questions or problems to be solved.
10. In a good lesson plan, time allotment for each unit is clearly indicated.
11. A good lesson plan has the option for self criticism so the improvement for a future reference may be noted.

## **PARTS OF GENERAL LESSON OF PHYSICAL EDUCATION**

General lesson of physical education is divided into the following parts:

1. Assembly & roll call
2. Warming up exercises
3. Formal activities
4. Special activities
5. Recreative activities
6. Assembly & dismissal

### **Assembly & Roll Call**

It is very essential for the success of physical activities that student must be disciplined and physical education must be made a regular activity. Hence students must be ordered to gather in the school grounds. Attendance should be taken after the students have gathered. Absentees must be noted and called next day or in the next period to explain absence.

### **Warming up Exercise**

A certain amount of warming up is essential before indulging in any vigorous activity. The warming up shall consist of a few informal activities like running, hopping, jumping, skipping, imitation of the animals, locomotives etc. which are to be stated in a slower rhythm and finished with a faster rhythm. About  $\frac{1}{8}$  of the total time of the period may conveniently be devoted to warming up. It must be particularly note that the entire class is fully engaged in warming up.

### **Formal Activities**

Formal activities form an important part in a lesson because of their high physiological values. They develop and maintain body control, body suppleness, good posture and graceful carriage of the body. These activities are done to commands. They include calisthenics (Free Arm exercises)  $\frac{1}{4}$  of the total time of the periods is to be utilized for the formal activities.

### **Special Activities**

The special activities may be conducted after the formal activities. It is not imperative to include special activities in every general lesson; it included, about  $\frac{1}{6}$  of the total time may be utilized. They include Asanas, Light apparatus, Dands, Baithaks, Lezium, Suryanamaskars, etc.

### **Recreative Activities**

These consist of a variety of minor games, lead-up games, story plays, simple stunts and combats, relays, etc., No lesson is complete without recreatives activities because they not only develop the natural skills but also provide fun, pleasure and enjoyment to the participants. Therefore  $\frac{1}{2}$  of the total time must essentially be devoted for these activities.

### **Assembly & Dismissal**

As part of the class management assembly and dismissal of the student at the end of the lesson plan form the regular class routine. At the end recreative activities, all equipment are gathered and kept in the proper place after which the students assemble for orderly dismissal.

## MODEL LESSON PLAN FOR GENERAL

S.NO	SUBJECT MATTER	METHOD
1	Assembly and Roll call (2 minutes)	Assemble the students, make the students to fall in a single line according to their height and then the attendance is taken
2	Introductory (or) Warming upto (5 minutes)	Students are asked to run fast on the circle while running they should perform all movements-imitating birds, animals and other things such as aero planes, motor cars, engines and whistling. They produce sounds like barking of dogs, ducks and cows; this will prove to be quite an interesting activity in which the participants exhibit extraordinary interest.
3	<p>Formal activities (10 minutes)</p> <ol style="list-style-type: none"> <li>1. Free apart jump arms sideward raise</li> <li>2. Legs together, hands on his</li> <li>3. Same as one</li> <li>4. Come back to position</li> </ol>	<p><b>a. Class Formation:</b></p> <p>The open order formation shall be made from a single line by conveniently numbering the students according to the strength of the class and allowing ample space among them. The teacher shall so station himself that he can see all and be seen by all.</p> <p><b>b. Demonstration</b></p> <p>The exercise shall properly be demonstrated by the teacher with due explanation.</p> <p><b>c. Teaching by counts</b></p> <p>The demonstrated exercise shall be taught by counts (Hold each position and correct the mistakes.</p> <p><b>d. Doing continually and Rhythmically</b></p> <p>after teaching by the counts exercise shall be done a few times for physiological effects</p>
4	<p><b>Special Activities (10 minutes)</b></p> <p><b>Padmasana</b></p>	After the exercise, the student will be brought back to single line. The class formation shall be semi circular

	<ol style="list-style-type: none"> <li>1. Right foot over the left thigh</li> <li>2. Left foot over the right thigh</li> <li>3. Keep the hands on the knees of chin mutura</li> <li>4. Breathing should be slow and steady and deep</li> <li>5. Maintain the position for a while</li> </ol>	<p>formation, allowing space for each student.</p> <p>The 'asana' should be demonstrated properly according to the counts emphasizing the accuracy and precision of each position.</p> <p>The student shall be made to do the asana by counts. Corrections are made then and there. The 'Asana' shall be done only in slow counts.</p>
5	<p><b>Recreative Activity</b> (10 minutes) Three Legged Relay</p>	<p>Arrange the team in file behind the starting line in pairs. Tie the two inner legs together. At the given signal the first pair of each team runs to the end line and turning back and touches off the next pair, who repeats. The first team to complete wins the relay.</p>
6	<p>Assembly and Dismissal (3 minutes)</p>	<p>After all the recreative activity the students will be made to assemble and fall in a line on the command dismissal they have to do clap thrice (1, 2, 3) (1, 2, 3) (1, 2, 3) and disperse.</p>

<p><b>Check your progress</b></p> <p>Notes : a) Write your answer in the space given below</p> <p style="padding-left: 40px;">b) Compare your answer with the those given at the end of the unit</p> <p>1. Mention a few suitable methods of teaching physical science</p> <p>-----</p> <hr/> <p>2. In the general lesson plan of physical education there will be -----</p> <p>a) 5 b) 6 c) 4 d) 2 <span style="float: right;">(    )</span></p>
---

## 2.6 INTRAMURAL COMPETITIONS

It is a phase of a physical education programme in a school college university or any other organization geared to the abilities and skills of the entire student body or the members of the organization.

### **Meaning of Intramural Competition**

The word “Intramural” is the combination of two Latin words “Intra plus ‘Mural.’ ‘Intra’ means ‘inside’ and ‘Mural’ means ‘wall’. Thus, ‘intramural’ means ‘inside the wall’. Organization of physical activities within the four walls of an institution for the students of that every institution is ‘Intramural Meet’.

This ‘Meet’ is organized by dividing the students of the school concerned into various groups. Because this ‘Meet’ is only held for the students of a particular school, therefore, students of other schools are not allowed to participate in it. For the successful organization of ‘Intramural Meet’ all the students of the school are divided into various ‘Houses’/ ‘groups’.

### **Objectives of Intramural Competition**

1. Providing equal opportunity to every student to participate in one or more activity
2. Providing opportunity to learn basic skills of different games and sport
3. Creating the spirit of sportsmanship among students
4. Providing practical knowledge on planning, organizing and administering play programmes.
5. Developing leadership and followership qualities in students.
6. Developing qualities like co-operation and team cohesion etc
7. Constructive leisure activity and a good entertainment which provides more fun and joy.
8. Helps in identifying and selection of talented players for school teams.
9. Creates oneness among students leaving society and economical disparities
10. Makes students more disciplined and law abiding

### **Conduct of Intramural competition**

Before conducting the intramural competitions, the following factors have to be taken into account for achieving the desired results.

1. Type of the institution i.e. residential, partially residential, non residential and so-on.
2. Geographical and Climatic conditions
3. Infrastructure/facilities available (play-grounds, track, equipment, leadership etc.)
4. Availability of estimated finances
5. Availability of time
6. Identification of activities in which students take keen interest.
7. Cooperation and help from administration and fellow teachers.

## **INTRAMURAL COMPETITION COMMITTEE**

The intramural competitions are conducted by the intramural committee which is headed by the headmaster of the school concerned. This committee usually comprises of the following:

### **The intramural Director**

He will always be the senior most teacher of physical education faculty of an institution.

### **Assistant Director**

One among the remaining teachers of physical education who are assisting the director is appointed Assistant Director.

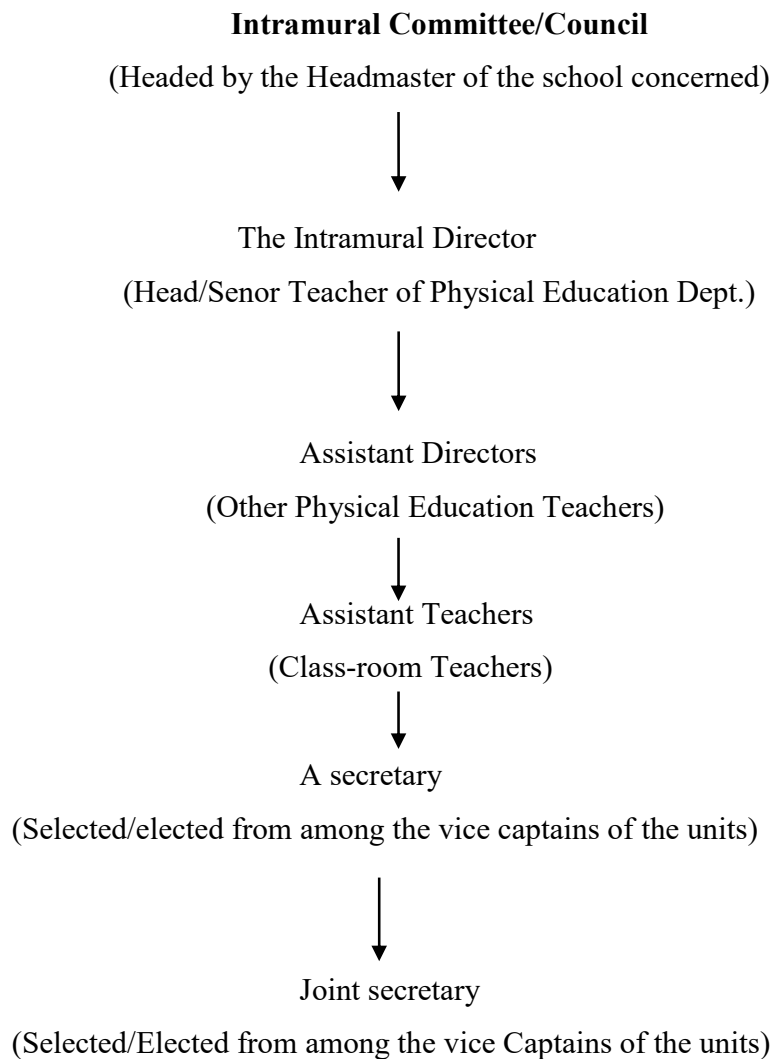

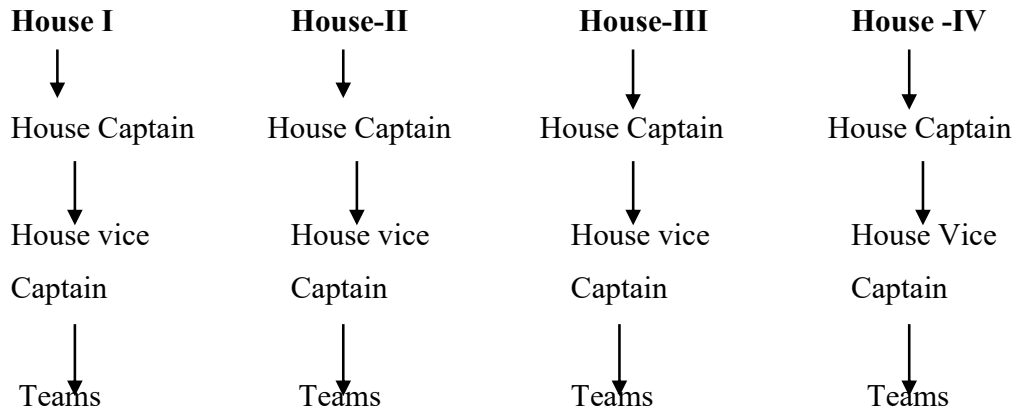

**Assistant Teachers**

The Director and Assistant Director are further assisted by the class-room teachers when competitions are held.

**A secretary**

A secretary of the Intramural Committee is either selected or elected from among the captains of the units (Houses)

It is the duty of the Secretary to keep a record of the meetings held, the results of the competitions and the score sheets. To develop the leadership qualities to develop the organizing and conducting ability, to develop the decision making ability, to develop the habit of sharing responsibility, and so develop/create interest in students in the intramural competitions, their involvement should be maximum at all the levels.

**Joint Secretary**

A joint secretary of the intramural committee is either selected or elected from among the vice-captains of the units (Houses)

**Selection of events/competitions for the Intramural Competition**

While selecting the competitions for intramurals, three items need to be kept in mind; the facilities, time and finances available. The interest of the students shall also be taken into consideration while deciding activities for competition.

It is the responsibility of the Intramural committee to frame rules and regulations for the competitions. While framing rules for the competition of a particular game/spot, standard rules as well as prevailing condition on campus ‘must be kept in mind. If there is any deviation from the standard rules, participants must be informed .protests, if any, are to be decided by the committee.

### **Time and Type of Competition**

The type of competition depends upon the number of teams and number of play fields available, and the time availability. The time best suited for conducting competition is after teaching hours. The ideal months to organize the intramural competitions are the first three to four months from the commencement of the academic year. Sometimes the Intramural competition shall be conducted throughout the year. Light programme shall be conducted at the end of the year due to the forthcoming examinations. Further the competitions may be conducted either on knock out or league basis.

### **Officials**

Qualified and competent officials are necessary for a sound intramural programme. Officials should be well-versed with rules of the game/sport and should possess a complete understanding on the level of participants, the objectives of the programme, and the organization philosophy of competition. They should be fair and transparent in their decisions.

### **Point system and scoring Procedure**

A point system shall be developed in such a way, that it stimulates healthy competition, maintains continued interest and should be in conformance with the objectives of total programme. The point system should **readily** understood by all and easy to administer. Under such conditions, points should be awarded on the basis of contests won, championships gained, standing in a league or order of finishing, unit participation, and so on. The point system is decided by the Intramural Committee before the commencement of intramural programme in the beginning of the session. The point systems may be developed as given below and required modifications may be made, if any

1 <sup>st</sup> place in team championship	:	10 points
2 <sup>nd</sup> place in team championship	:	6 points
3 <sup>rd</sup> place in team championship	:	3 points

Or

1 <sup>st</sup> place in individual championship	:	6 points
2 <sup>nd</sup> place in individual championship	:	4 points
3 <sup>rd</sup> place in individual championship	:	3 points

Or

Each entry	:	10 points
------------	---	-----------



Each win	:	2 points
Each Draw	:	1 point
Each loss I forfeit	:	0 point

The points gained by a team/an individual should be credited to the unit. There shall be two score sheets, one to enter the points scored by each team in day to day competitions and the other a consolidated score-sheet showing the points gained by each unit. The total points scored by each unit at the end of the intramural competitions will be taken for deciding the intramural championship.

### **Awards**

Some kind of recognition must be given to the winners of intramural competitions and to the intramural champions and it can be done in the following ways.

1. Inscribing the names of the writing House Unit along with its captain on the intramural Honor board.
2. Displaying the photograph of the school champion on the student notice board.

## **2.7 EXTRAMURALS COMPETITION**

### **Meaning of Extra murals**

Extramural competitions are conducted between the player of two or more institutions. In such competitions selected players represent their institution in a particular game or sport in order to show their skill and being honor to their institution, examples for such competition are inter college, inter university etc.

### **Conduct of Extramural Competitions**

To have better and result oriented extramural competition from the conduct and organizing point of view they may be categorized and studied under three main heads.

- a) Practice Matches
- b) Closed Competitions
- c) Open Competitions

### **Practice Matches**

Before the official scheduled competition, practice matches are arranged with the neighboring institutions clubs of a given locality and played for the training purposes. These matches help both the teams to look into their weaknesses and follow the remedial measures. It

provides competition experience and also helps both the teams to develop socialization. These matches are fixed before hand with the understanding of both the teams and institutions.

### **Closed Competitions**

The name of the competition is self explanatory. These competitions are limited to particular types of institution. For instance inter school competition, inter college competition, and inter university competition and so on. Generally these competitions are conducted by their respective sports departments or sports boards/committees. To have better control and achieve desired result the entire jurisdiction of competing institution is divided into different zones. After the completion of the competitions in each zone, winners will meet in the inter zonal competition for the institutional championship.

### **Open Competitions**

In the open competition anybody can participate through their respective affiliated units. It is not confined to any one category of people. In the open competition any institution, department, or private agency is eligible to field a team.

## **2.8 TOURNAMENT**

The dictionary meaning of tournament is a large contest of many rounds among various teams.

A tournament is a competition held among various teams in a particular activity according to a fixed schedule where a winner is decided.

### **Types of Tournaments**

There are various types of tournaments and selected few are discussed in detail. The four main types of tournaments are listed below:

1. Knock-out or elimination Tournament
2. League or Round Robin Tournaments
3. Combination Tournaments
4. Challenge tournaments

Each major type of tournaments has many sub classification. Each sub type serves different needs of the organizers.

The sub types of major tournaments are given below:

### **Knock-out or Elimination Tournaments**

- Single Knock-Out or single elimination Tournament
- Consolation Tournament (Type I stand type II)
- Double Knock-out or double elimination tournament
- Bangnall-wlid elimination tournament

### **League or Round Robin Tournaments**

- Single League Tournament
- Double League Tournament

### **Combination tournaments**

- knock out-Cum-Knock-Out Tournament
- Knock-Out-Cum-League Tournament
- League-Cum-League Tournament
- League-Cum-Knock-Out Tournament

### **Knock-out or Elimination Tournaments**

#### **Single knock out or single Elimination Tournament**

##### **Meaning**

In this type of tournament the team which is defeated once, gets eliminated immediately and will not be given another chance to play.

##### **Method or drawing fixtures for single knock out or single elimination tournament**

The total number of matches to be played in this tournament will be equal to  $n-1$ , i.e., total number of teams participating minus one. For example, if 12 teams are participating and competing, then the total number of matches to be organized will be  $12-1=11$ .

##### **Method of determining the number of teams in the upper half and lower half**

In both the illustrations given below, a small letter 'n' stands for total number of teams competing in the tournament.

a) When the number of teams is EVEN; then

The teams in the upper half would be  $n/2$

The teams in the lower half would be  $n/2$

For instance, there are 12 teams, and then the number of teams in the upper half and lower half would be

$$\frac{n}{2} = \frac{12}{2} = 6 \text{ teams in each half}$$

**b) When the number of teams is ODD; then**

The team in the upper half would be  $\frac{n+1}{2}$

The team in the lower half would be  $\frac{n-1}{2}$

For example, there are 21 teams: the teams in the upper half would be

$$\frac{n-1}{2} = \frac{21-1}{2} = \frac{20}{2} = 10$$

The teams in the lower half would be  $\frac{n+1}{2} = \frac{21+1}{2} = \frac{22}{2} = 11$

**Method of determining the number of Byes** to be given in the upper half and in the lower half in both the illustrations given below, combined small letter ‘nb’ stands for total number of byes to be given in the fixture.

- a. When the total number of ‘Byes’ is EVEN:

For example there are six byes; then

The byes in the upper half would be  $nb/2=6/2=3$  byes.

The byes in the lower half would be  $nb/2=6/2=3$  byes

- b. When the total number of ‘Byes’ is ODD’ for example there are 11 byes’ then

Byes in the upper half would be  $\frac{nb-1}{2} = \frac{11-1}{2} = \frac{10}{2} = 5$  byes

Byes in the lower half would be byes  $\frac{nb+1}{2} = \frac{11+1}{2} = \frac{12}{2} = 6$  byes

### Check your progress

Notes : a) Write your answer in the space given below

b) Compare your answer with the those given at the end of the unit

3. The contextual meaning of 'intramural' is...

a) Outside the wall b) between group c) between houses d) inside the wall ( )

4. Find out the major types of tournaments.

## 2.9 Drawing Fixture

Before drawing a fixture, two things are ensured i.e., whether the number of teams participating is a power of two or not. This information decides whether any bye's shall be given or not. This makes the difference in the method of drawing fixture. Further, in case the number of competing teams is not a power of two the byes shall be given irrespective of the odd/even number of teams. In other words, if the number of teams is a power of two byes are not given.

Now, the question arises that how do we decide the number of byes? The number of byes depends upon the distance between the actual number of teams competing and next power of two i.e. over and above the competing number of teams.

For instance the number of competing teams is 9, and then the next power of two will be  $2^4 = 2 \times 2 \times 2 \times 2 = 16$  which is over and above the competing number of teams. Therefore the number of byes will be  $16 - 9 = 7$ . To have better understanding, for the both the conditions are discussed separately.

Drawing a fixture for a certain number of teams competing, the number being the power of TWO ( $2, 2^2, 2^3, 2^4, 2^5$ , i.e. 2, 4, 8, 16, 32 respectively). In this case bye/s shall not be given. Suppose 16 teams A,B,C,D,E,F,G,H,I,J,K,L,M,N,O and P have entered for a tournament for which the fixture shall be drawn in the following manner, how to draw fixture for teams competing in even number?

### If the number of teams competing are 8

By putting lot, plot the team's starting from bottom and again in top and so on until you fix all teams. For example, the teams 1, 7, 4, 5 have been plotted in the upper half and the teams 8, 2, 6, 3 in the lower half. Lot is drawn to avoid biased fixtures. Since the number of teams competing are in even number and also in the power of 2.

Number of bye shall be

$N=8$

Power of two=8

Therefore;  $\text{Bye}=8-8=0$ . No bye shall be given

Now pair the teams for first round matches

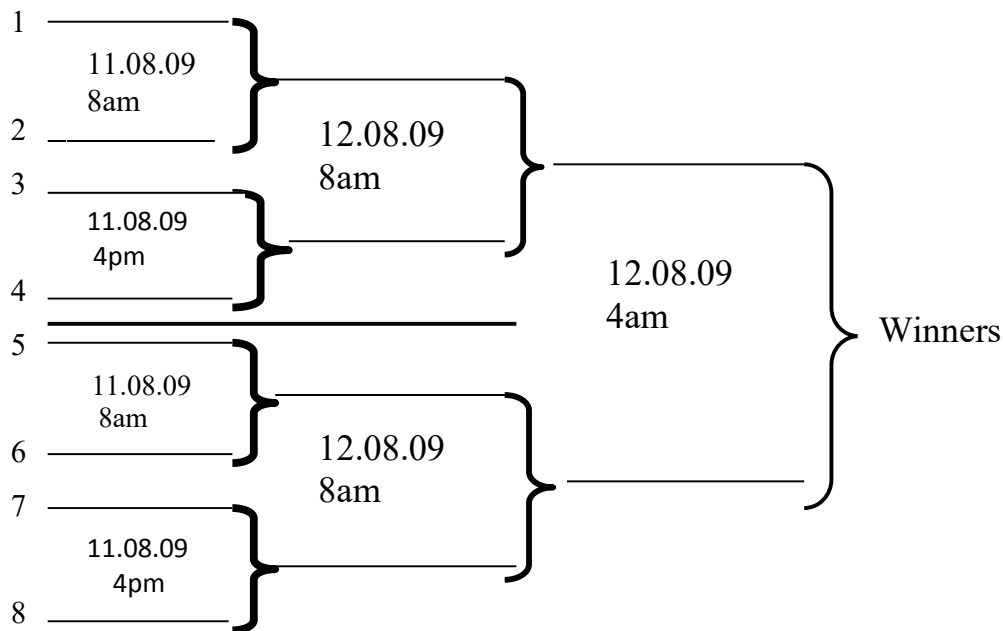

**If the teams competing are 12**

First we shall discuss if. 12 teams have entered for completion the next higher number above which is the power of TWO is 16. Consequently, the number of Byes to be given shall be  $16-12=4$ .

BYE is a privilege/advantage given to a team generally by drawing lots, exempting it from playing a match in the first round.

- i. A rest before a competition is not so-advantageous as a rest after a match the intensity of degree of competition may not be of a high degree in the first round. Now we shall deal with the method of drawing fixtures for 12 teams (L,M,N,O,P,Q,R,S,T,U,V and W), that have entered for the competition.

Now, write on a sheet of paper the serial number 1 to 12 we know that four byes are to be given; first of all we have to draw lots for giving byes. Paper slips shall be used for drawing lots. Following the same procedure of writing slips as discussed earlier. Each slip is taken out, find the name of the concerned team, receiving the benefit of bye and enter it alternately beginning

from the bottom of the lower half and followed by the top of the upper half of the fixture and then top of the lower half followed by bottom of upper half.

For example, the order in which the lots are drawn for byes is NQ S & L. They shall be entered as per the procedure explained, i.e., team N is entered on serial No.12, team Q on Serial No.1, team S on serial No.7 and, team L on serial No.6 (as shown in fixture drawn and given below). The serial number 2, 3, 4, 5, 8, 9, 10 and 11 are vacant. The teams M, O, P, R, T, U and V & w are not entered in the fixture. Now lots are to be drawn is TMVPROW & U. they have to be entered in the vacant serial numbers from the top to the bottom in the order in which they are drawn. Then those teams that are not given byes are bracketed in pair's form the top and they will play in the first round while the teams that got the byes will be playing in the second round. For the second and the subsequent rounds the teams should be bracketed in pairs starting from the top. For more clarity, see the fixture given below.

1st Round 2nd Round 3rd Round 4th Round

1. Q (Bye) (Quarter Final) Semifinal

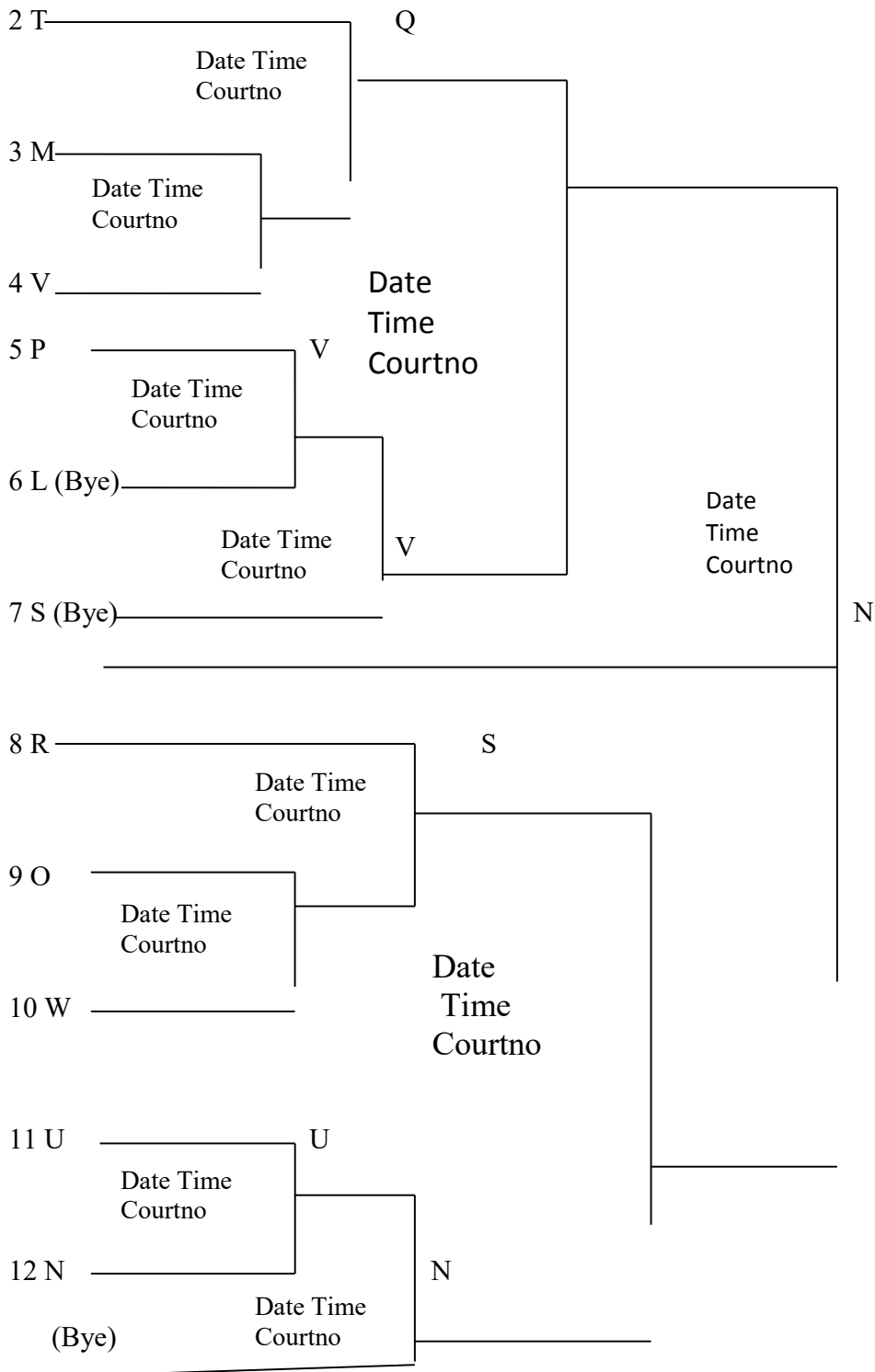

Team N is winner of the Tournament



### **Fixture for single knock-out/single elimination tournament for 13 teams**

Participating teams are A, B, C, D, E, F, G, H, I, J, K, L, M, N, =13 No. of byes to be given (subtracting the number of teams from its next higher number which is the power of two i.e.,  $16-13=3$ )

### **Seeding Method**

It is a way of sorting of the teams and fitting them into the fixtures, so that stronger teams don't meet in the earlier rounds. This method is applicable only when the standard of the teams is known to the organizers. The seeding number is generally power of two i.e., 2, 4, 8, 16 etc.

The seeding method is applied to keep up the interest of the spectators alive till the last match of the fixture. Except the seeded teams, rests of the teams are allotted places in the fixture by lots. The seeded teams are equality divided in both the halves. It is also recommended that byes are generally given to the seeded teams either arbitrarily or by drawing lots among them.

**Example:** Seeding four teams where total number of participating team is eleven.

**Solution:** in a competition 11 teams from various places of Tamilnadu are participating. The numbers of bytes shall be  $16-11=5$  bytes. Seeding is given to only four teams. Thus four seeded teams shall be given four byte and fifth bye to any other team.

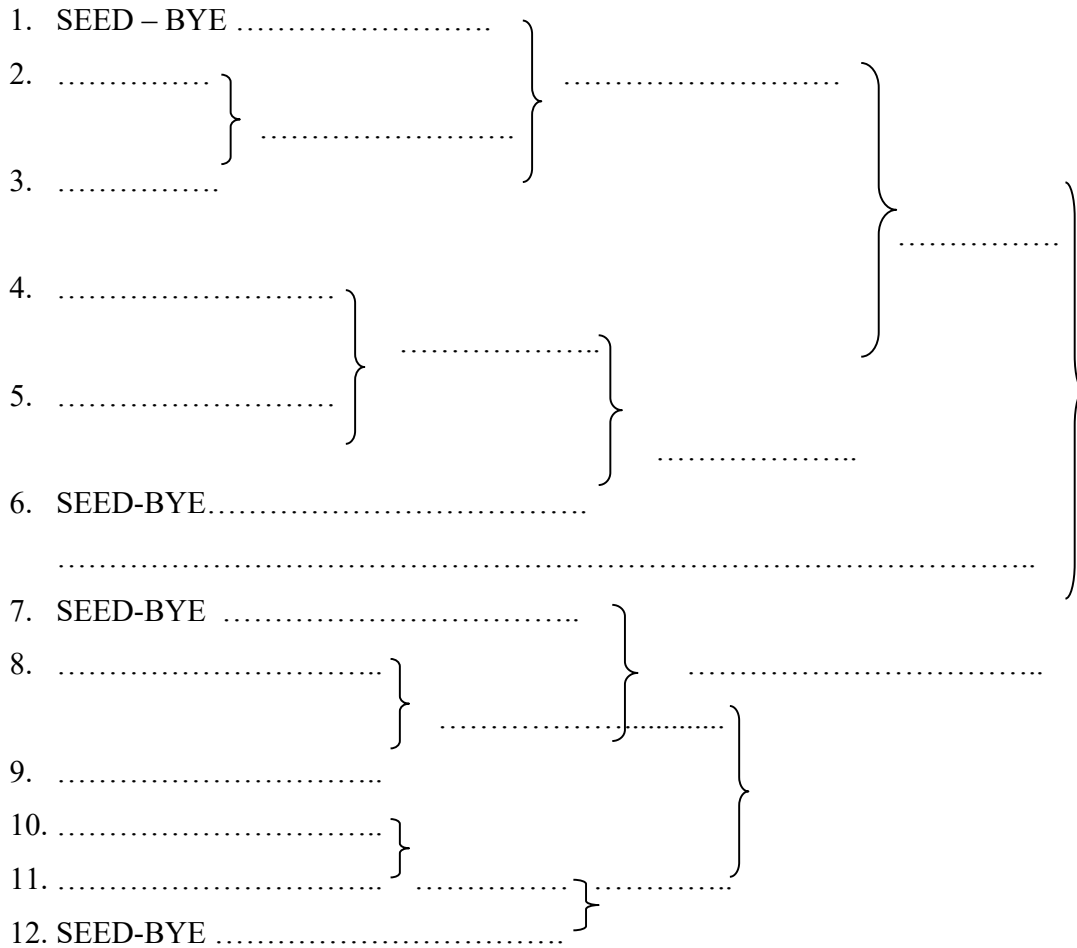

### Merit and Demerits of single knock-out or single Elimination

**Merits:**

1. There will be economy of expenditure
2. The competition will be keen and intense because of the fear of elimination of a team from the tournament, the moment it is defeated.
3. The tournament can be finished in a short period of time.

**Demerits:**

1. The fixture is drawn purely by lots, there is a possibility of the strong teams being matched together in the early rounds or even some time in the very first round and get eliminated. Hence giving an opportunity for the weaker teams to move to the semifinals and the finals. It results to make the tournament matches boring for the spectators.

2. A good team may get itself eliminated by change or by accident and it will not have another chance to play and show its real worth.
3. A winner of a particular round may have to wait to meet the winner of another
4. Due to some in-built defects in this type of tournament, some time true winner of the tournament is not decided.

## League or Round robin tournament

### Single League Tournament

In this type of tournament, every team shall play once with ever with ever other team. The total number of matches in a single league tournament shall be  $\frac{n(n-1)}{2}$  10 team are competing, the total number of matches to be played shall be:

e.g.

$$\frac{N(n-1)}{2} = \frac{10(10-1)}{2} = \frac{10(9)}{2} = \frac{90}{2} = \frac{45}{1} \text{ matches}$$

(Small 'n' stands for total number of teams)

Methods of league tournament

- i. Cyclic method
- ii. Tabular method
- iii. Stair case method

**Note:** while drawing the fixture with cyclic method the following things are determined beforehand. This will help your to make cross checks.

To know the rightness of your fixtures

1. Total number of matches
2. In case of even number of teams, number one is fixed. The other number are rotated clock-wise
3. In case of odd number of teams, bye is fixed, all the teams are rotated clock-wise
4. The total number of rounds for even number of teams shall be  $n-1$  and for odd number of teams shall be 'n' rounds ('n' stands for total number of teams).

### Cyclic Method

Suppose the number of team is 8 i.e. even number

$$\text{No of matches} = \frac{n(n-1)}{2} = \frac{8(8-1)}{2} = \frac{8(7)}{2} = \frac{56}{2} = 28 \text{ matches}$$

No of rounds  $n-1=8-1=7$

First round	Second round	Third round	Fourth round	Fifth round	Sixth round	Seventh round
8-1	7-1	6-1	5-1	4-1	3-1	2-1
7-2	6-8	5-7	4-6	3-5	2-4	8-3
6-3	5-2	4-8	3-7	2-6	8-5	7-4
5-4	4-3	3-2	2-8	8-7	7-6	6-5

Suppose the number of teams is 7 i.e odd number

$$\text{No of matches} = \frac{n(n-1)}{2} = \frac{7(7-1)}{2} = \frac{7(6)}{2} = \frac{42}{2} = 21 \text{ matches}$$

No of rounds =  $n = 7$

First round	Second round	Third round	Fourth round	Fifth round	Sixth round	Seventh round
7-Bye	6-Bye	5-Bye	4-Bye	3-Bye	2-bye	1-Bye
6-1	5-7	4-6	3-5	2-4	1-3	7-2
5-2	4-1	3-7	2-6	1-5	7-4	6-3
4-3	3-2	2-1	1-7	7-6	6-5	5-4

## II Tabular Method

In this method the fixtures are drawn in a tabular form. The number of column shall be drawn horizontally as well as vertically. The number of columns depends on the number of teams, i.e., Even or Odd.

For even number of teams, the number of columns shall be  $n+1$  and byes shall not be given, whereas for odd number of teams, number of columns shall be  $n+2$  and byes shall be given. Here 'n' stands for number of teams.

**Procedure for drawing columns**

1. Draw the required number of columns horizontally and vertically
2. Draw a line diagonally from the left top most corner to the opposite right bottom corner.
3. Enter the terms and bye if needed in the space of the first vertical column as shown in the illustration given below.
4. The squares that fall on one side of the diagonal line except squares in the BYE columns indicate the matches to be played in a single league.
5. The numbers that are entered in the squares indicate the particular rounds in which the concerned teams have to play.

**Procedure of entering the numbers inside the squares indicating the rounds**

1. In the squares of the horizontal column immediately below the teams, enter the number serially from number one (1) onwards.
2. The number in the last square of that horizontal column indicated the maximum number of rounds for the league(see the examples given below and below)
3. Then in each vertical column (except the last vertical column) enter the number serially starting from the number next to that placed at the top.
4. The serial numbers to be entered in any of the squares should not exceed the number indicating the maximum number of rounds.
5. The entry of numbers in the squares of the last vertical column will be as follows:

**Fixture for 6 teams (A, B, C, D, E & F)**

**Number of columns  $n+1=6+1=7$**

	A	B	C	D	E	F
A		1	2	3	4	5
B			3	4	5	2
C				5	1	4
D					2	1
E						3
F						

**Fixture for 7 teams (A, B, C, D, E, F & G + Bye)**

**Number of columns  $n+2=7+2=9$**

- a) Note the number entered in the top square of the vertical column
- b) In the next immediate underneath square enter number 2.
- c) Then proceed entering numbers in the others squares every time adding 2, (i.e., 4, 6, 8 etc) until the number becomes one less than number at the top most square.
- d) Now enter 1, in the next square and proceed entering the number in the other squares every time adding 2, (i.e., 3, 5, 7, etc) until the bottom-most square is filled up.
- e) It may be noted that the number of the bottom most square will be two less than the number at top most square.

**Stair case Method**

The fixture can also be drawn with the help of stair-case method, as illustrated below, but there are certain draw backs in this method, such as:

- a) It does not indicate the number of rounds to be played.

	<b>A</b>	<b>B</b>	<b>C</b>	<b>D</b>	<b>E</b>	<b>F</b>	<b>F</b>	<b>F</b>
<b>A</b>		1	2	3	4	5	6	7
<b>B</b>			3	4	5	6	7	2
<b>C</b>				5	6	7	1	4
<b>D</b>					7	1	2	6
<b>E</b>						2	3	1
<b>F</b>							4	3
<b>G</b>								5
<b>Bye</b>								

- b) It is not so easy to fix the matches of the concerned round as in the case of either cyclic method or the Tabular method.

**Fixtures for 9 teams**

On each step/stair one team on the left side of each round is fixed starting from its team onwards till the last two teams play.

1-2									
1-3	2-3								
1-4	2-4	3-4							
1-5	2-5	3-5	4-5						
1-6	2-6	3-6	4-6	5-6					
1-7	2-7	3-7	4-7	5-7	6-7				
1-8	2-8	3-8	4-8	5-8	6-8	7-8			
1-9	2-9	3-9	4-9	5-9	6-9	7-9	8-9		

### Procedure of deciding winners in the league tournament

The winner of the league tournament will be decided on the basis of the points scored by the respective teams in the following manner.

- a) For a win 2 points
- b) For a defeat 0 points
- c) For a draw match 1 point(each)

The team that gets the maximum number of points will be declared winner. In case of a tie, it shall be broken according to the rules framed by the tournament organizing committee before the commencement of tournament. Different procedures are adopted for breaking tie in different games/sports.

### Merits and Demerits of league or Round Robin Tournament

#### Merits

1. It decides the true winner, since all the teams are treated at par in the fixtures.
2. Greater number of matches can be played by teams
3. It helps in ranking all the teams
4. The teams need not wait for completion of the other rounds as in single knock-out tournament
5. All the teams get equal chances to play with each other, nothing remains to a chance while drawing fixtures as per the in-built characteristics of this type of tournaments

### **Demerits**

1. It involve lot of time, money and facilities
2. Teams that get defeated often will lose interest in the game and that particular match becomes boring for the participants, spectator and even for officials
3. There is no provision of seeding for the very outstanding or well known top teams.

### **Improved Appearance**

- Weight loss.
- Toned muscles.
- Improved posture

### **Enhanced social life**

- Improved self image.
- Increased opportunities to make new friends.
- Increased opportunities to share an activity with friends' family members.

### **Increased stamina**

- Increased productivity.
- Increased physical capabilities injuries.
- Less frequent
- Improved immunity to minor illnesses

## **2.10 RULES AND REGULATION OF GAMES**

### **BALL-BADMINTON**

#### **TIPS TO REMEMBER**

#### **Dimension of the court:**

#### **Playing Area:**

- |                |          |                                     |
|----------------|----------|-------------------------------------|
| <b>Five</b>    | <b>:</b> | 24mx12m (five players on each side) |
| <b>Doubles</b> | <b>:</b> | 24mx6m (two players on each side)   |

#### **Post**

The height of the post is 2m. The pose should be place with the distance of maximum 1m outside the court. A hook must be fixed at 1.50m height to each post for convenience of lightening the net.



## Wet

It shall be tri-coloured (Red, White and Blue). It shall be 1m wide and 13.5 length and 2cm square mesh.

## Net Height

The height of the net on the side tops shall be 1.85 and it shall be 1.83m at center.

No of players	-	5
Substitute	-	5
Points	-	29

## Officials

Umpire	-	1
Line Referees	-	2 (or) More
Scorer	-	1

## BALL-BANMINTON COURT

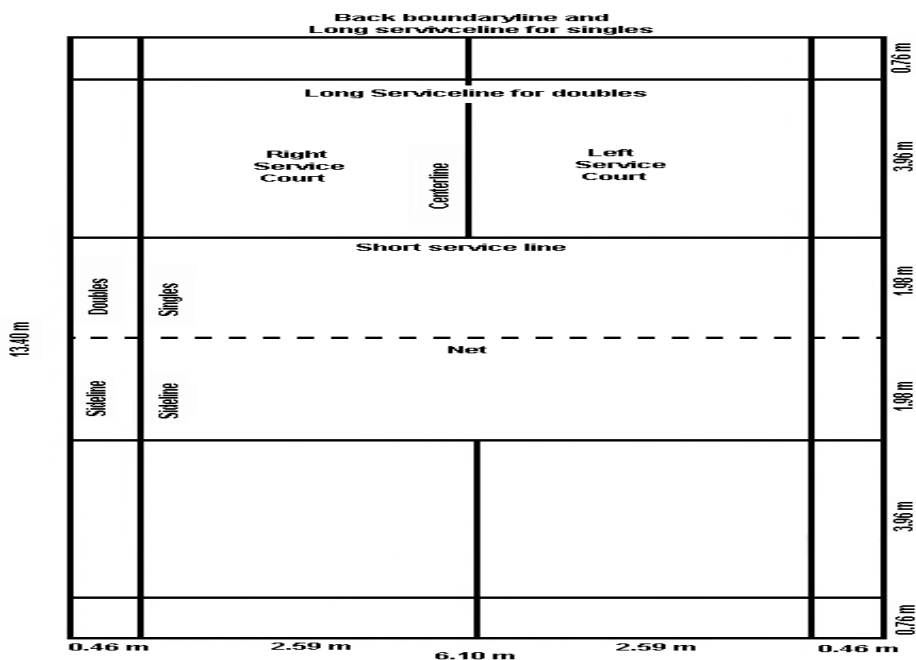

## FUNDAMENTALS SKILLS

### Holding the Racket

Wrap thumb diagonally around the racket grip, with thumb contracting middle finger at the first point. While receiving the ball player should have a strong grip. Players can hold the racket according to their convenience.

## **Service**

There are two types of service. Under hand service and spin service. The server sends the ball to the opponents' side diagonally, keeps the ball in one hand and throws it to a convenient height and hit the ball on the side. The server should see the weak player and he has to serve the ball to him.

## **Smash**

There are several types of smash. The plain smash can be made by the front line players while the ball coming with good height meeting the ball at the maximum height and to have force arms should go backward. The spin smash will be by the centre and back players. To avoid the ball going out and touching outside the boundary sufficient spin should be given while smashing the ball near the end line. It is very difficult for the opponents to receive the ball.

## **Receiving**

The players should watch the speed, height and spin of the ball for the effective receiving. Meeting the ball at height is advantageous. It is not possible for the ball can be taken by underhand.

Front players may stand close to the net and shunt the ball the combination of players is very much essential for receiving. This can be achieved only by regular practice.

## **RULES OF THE GAME**

1. The game is played by two sides of 5 players. The game consist of 29 points, a match shall consist of 3 games. The team that takes the best of 3 games shall be declared with her.
2. At the commencement of a match the umpire shall allow two trials, one from each side and after the trials are over the umpire shall call play.
3. In case of fives tournament the team consists of Eight players whose names are Furnished before the commencement of the tournament and any five o them shall play while the other three shall be physically present.
4. The serving team shall always have five hands to serve even at the commencement of every game.
5. The ball shall be served by a player underhand and below the waist. It shall go clear over the net and beyond the serving crease line and within the end line on the other side of the net.

6. The match shall consist of three games. The team that takes the best of three games shall be declared as winners.

Note: a server shall be considering being stationery only if both of his feet touch as the ground at the time of service. It is sufficient that any portion of each of the foot touches the ground while in the act of service.

7. It is a fault if any portion of the server's body or racket crosses any of the lines when serving (even a foot on line is out of court).
8. It is a fault if the serving ball falls on any line. But a ball in rally becomes a fault only if it falls on the boundary lines; it can fall on the centre or crease line.
9. There shall be an interval of 2 minutes between the end of the first game and second game and 5 minutes between the second and third.
10. In each game immediately after the first 8<sup>th</sup> 15<sup>th</sup> and 22<sup>nd</sup> pints the teams shall changes the sides.
11. During the course of any match of two or three games, three substitution/change of player shall be allowed in each game if required by the captain/ manager of the team. The substitution can be made at any time during the game. Once the game is stopped on request for making a substitution, the substitution should be executed.
12. In the event of a match being suspended by the umpire for reasons of light or weather or any other reason. It will be continued form the point at which it was stopped.
13. In the event of a game between two or more teams in any tournament, matches shall never be replayed (Ranks) on basis of games score and on the basis of point score if tie still persists, shall be declared

## **VOLLEY BALL**

### **TIPS TO REMEMBER**

#### **Dimension of the court:**

Length	-	18m
Width	-	9m
Free zone area	-	3 to 5m on sides
	-	10m at end lines
Width of marking line-		5c

## Net

Length	-	9.5m
Width	-	1m
Height-Men	-	2.43m
Women	-	2.24m
Net mesh	-	10cmx10cm

## Antennae

Length	-	1.80
Diameter	-	10mm
Height above the net	-	80cm
Red & white marketing-	-	10cm

## No. of Players

Maximum 12 players (6 main players and 6 substitutes)

## Substitution

During a set, a team is permitted to make six substitutions

## VOLLEY BALL COURT

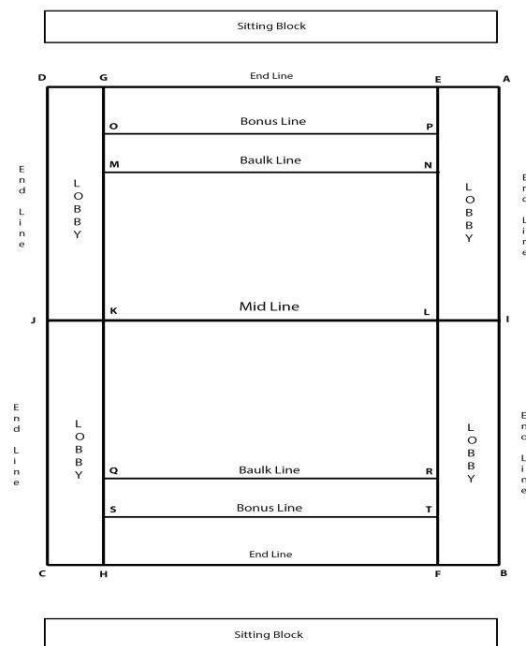

**Time out**

Two time out per team per set

Two technical time out per set

When the leading teams reach the 8<sup>th</sup> and 16<sup>th</sup> points (only 1 to 4 sets), no

Technical time out for 5<sup>th</sup> set

**Duration of time out**

30 seconds for team time out

60 seconds for team time out

**To win a set**

A set is won by the team which first scores 25 points with a minimum lead of two points.

**To win the Match**

The team that wins three sets wins the match in the case of a 2-2 tie, the deciding set (the 5<sup>th</sup> set) is played to 15 points with minimum lead of 2 points.

**Interval between sets**

Maximum interval of 3 minutes is allowed between each set of the match

**FUNDAMENTAL SKILLS****1. Digpas/underarm pass**

This is the most powerful weapon of defense and very commonly used to receive the service and also in floor defense. A service this pass is the first contact with the ball and player to the setter. This pass is performed with forearm.

**2. Upper hand pass**

Upper pass is usually performed with the fingers of the both hands over the head. This pass is used for the set up and increasing quality of attack.

**3. Underarm Service**

This is service is the first attack by a team, with the objectives of disturbing the opponents reception and to score a direct point.

**RELATED TERMINOLOGIES****Carrying the ball:**

The ball resting in player's hand before being cleared.

**Free ball:**

Returning ball to opposite side which is easy to handle

**Set:**

Placing the ball near and above the net to facilitate attacker to strike the ball

**Blocking**

Attempt to stop the attacking hit ball (a defensive play)

**Dead ball**

The ball that is out of play

**Service**

The method of putting the ball in play over the net by serving it with hand

**Point**

Failing to return the received ball

**Rotation**

Player moving clockwise when the service going to opposite side.

**Smashing**

Fitting the ball with open hand after the team mate lifts the ball

**Libero**

A defensive specialized player who is restricted to play only at the back court.

**RULES OF THE GAME**

- ❖ A team consists of twelve players; six playing and six remain substitutes. One player can play as a LIBRO.
- ❖ There is no fixed time duration to complete the game.
- ❖ A team which wins the gets the option to choose the reception or the service. The game starts with service. The serve hit the ball over the net into opponent's court.

**TO SCORE A POINT, TO WIN A SET AND THE MATCH****To score a point****Point:**

A team scores a point

- By successfully grounding the ball on the opponent's court
- When the opponent team commits a fault
- When the opponent team receives a penalty

## **Fault**

A team commits a fault by making a playing action contrary to the rules (or by violating them in some other way). The referees judge the faults and determine the consequences according to the rules

- If two or more faults are committed successively, only the first one is counted.
- If two or more faults are committed by opponent simultaneously, a double fault is called and the rally is replayed.

## **Rally and completed Rally**

A rally is the sequence of playing actions from the moment of the service hit by the server until the ball is out of play. A completed rally is the sequence of playing actions which results in the award of a point.

- If the serving team wins a rally, it scores a point and continues to serve;
- If the receiving team wins a rally, it scores a point and it must serve next.

## **TO WIN A SET**

A set (except the deciding, 5<sup>th</sup> set) is won by the team which first scores 25 points with a minimum lead of two points. In the case of a 24-24 tie, play is continued until a two-point lead is achieved (26-24; 27-25 ;....).

## **TO WIN THE MATCH**

- ❖ The match is won by the team that wins three sets
- ❖ In the case of a 2-2 tie, the deciding set (the 5<sup>th</sup>) is played to 15 points with a minimum lead of 2 points.

## **Service**

- ❖ The service is the act of putting the ball into play, by the back right player, placed in the service zone.
- ❖ The first service of the first set, as well as that of the deciding set (the 5<sup>th</sup>) is executed by the team determined by the toss.
- ❖ The other sets will be started with the service of the team that did not serve first in the previous set.
- ❖ The ball shall be hit with one hand or any part of the arm after being tossed or released from the hand(S).

- ❖ Only one toss or release of the ball is allowed. Dribbling or moving the ball in the hands is permitted.
- ❖ At the moment of the service hit or take-off for a jump service, the server must not touch the court (the end line included) or the floor outside the service zone.
- ❖ After the hit, he/she may step or land outside the service zone or inside the court.
- ❖ The server must hit the ball within 8 seconds after the first referee whistles for service.
- ❖ A service executed before the referee's whistle is cancelled and repeated.

### **Volley**

- i. Only three touches are allowed to a team
- ii. A player is not allowed to touch the ball twice in continuation. (A block is not considered in the count)
- iii. If the ball touches the boundary line is considered right
- iv. If the ball touches any part of the body is not considered as foul provided the ball must not rest.

### **Attack Hit**

#### **Characteristic of Attack Hit**

- ❖ All action which directs the ball towards the opponent, with the exception of service and block, are considered as attack hits.
- ❖ During an attack hit, tipping is permitted only if the ball is cleanly hit, and not caught or thrown.
- ❖ An attack hit is completed at the moment the ball completely crosses the vertical plane of the net or is touched by an opponent.

#### **Restrictions of the Attack Hit**

- ❖ A front-row player may complete an attack hit at any height, provided that the contact with the ball has been made within the player's own playing space
- ❖ A back-row player may complete an attack hit at any height from behind the front zone:
- ❖ At his/her take-off, the player's foot (feet) must neither have touched nor crossed over the attack line;
- ❖ After his/her hit, the player may land within the front zone
- ❖ A back-row player may also complete an attack hit from the front zone, if at the moment of the contact part of the ball is lower than the top of the net.



- ❖ No player is permitted to complete an attack hit on the opponent's service, when the ball is in the front zone and entirely higher than the top of the net.

### **Faults of the Attack Hit**

- ❖ A player hits the ball within the playing space of the opposing team
- ❖ A player hits the ball "out"
- ❖ A back-row player completes an attack hit from the front zone, if at the moment of the hit the ball is entirely higher than the top of the net.
- ❖ A player completes an attack hit on the opponent's service, when the ball is in the front zone and entirely higher than the top of the net
- ❖ A libero completes an attack hit if at the moment of the hit the ball is entirely higher than the top of the net
- ❖ A player completes an attack hit from higher than the top of the net when the ball is coming from an overhand finger pass by a libero in his/her front zone.

### **Blocking**

- ❖ The blocking actions are only performed closer to the net and interception of the ball coming from the opponent by reaching over the net within the playing space. Only front row players are permitted to perform completer block.
- ❖ Block attempt-the action of block without touching the ball. Except LIBERO any other player can perform block attempt
- ❖ Completer block-when the ball touches with the blockers is considered as completer block.
- ❖ Collective block when two or three blockers performed the block closer to each other and the ball touched by any of them is considered as collective block.
- ❖ A block contact is not counted in the team hit. After a block contact same team can touch or hit the ball three times.
- ❖ A team cannot block the service.

### **Blocking Faults**

- (i) Back row players or Libero cannot perform a completer block
- (ii) A libero cannot attempt an individual or collective block
- (iii) Blocking opponents service is fault
- (iv) Blockers are not allowed to touch the net

## **Libero**

A libero is specialized defensive player

- (i) Each team having right to play with to libero. A libero is included in the team composition. The uniform of the libero is different from his team players it must be numbered.

## **Role of libero during the match**

- (i) Only back row players can be substituted with libero
- (ii) Libero is not allowed to perform a complete attack hit from anywhere. The contact point with the ball by libero should not be higher than the top.
- (iii) Libero is not allowed to perform Service, Block or Attempt TO Block
- (iv) When the ball is set by the libero in the front zone a player cannot perform complete attack from higher than the top of the net.
- (v) When the ball is set by the libero from the back zone. A player can perform complete attack from anywhere and at any height

## **Substitutions**

- (i) Maximum six substitutions are permitted for each team in a set.
- (ii) A team can substitute one or more players at the same
- (iii) A player cannot be substituted twice in a set.

## **Substitution of LIBERO**

- (i) The substitution of a libero is unlimited or uncounted
- (ii) After coming out of the court libero can reenter only after one complete rally
- (iii) The libero can only be replaced by the player whom he replaced
- (iv) Libero can enter in the court when the ball is out of play of before the whistle of first reference.
- (v) At the start of each set libero cannot enter the court until the second referee not checked rotation.

## **Rotation**

The starting lineup of the team indicated rotation order of the players of the court. Rotation order of the team remains same until the set is completed.

Player is position there are six positions in the game. The first three players are front zone players and their position number 4(front left), number 3 (front centre) and number 2 (front

right). The other three players are back zone players and their position number 5 (back left), number 6 (back centre) and number 1 (back right)

Players are numbered anti clock wise and rotate clock wise. The player in position 2 rotate in position 1 to serve and the player position in 1 rotate to position 6 likewise rotation takes place.

## KABADDI

### Tips of remember

#### Dimension of the court:

Heads	Men	Women
Length (Side Line)	13m	12m
Width (End Line)	10m	8m
Lobby	1m	1m
Baulk line	8m	6m
Mid-line	10m	8m
Bonus Line from Baulk Line	1m	1m
Bonus Line	8m	6m
Sitting Block	8mx1	6mx1

#### Officials

- a. Referee - 1
- b. Umpires - 2
- c. Linesmen - 2
- d. scorer - 1

## FUNDAMENTAL SKILLS OF THE GAME/SPORT OFFENSIVE SKILLS

1. **Side kick** - In this skill the kicking leg is executed sideways. This skill is commonly used when the raider is attacking from the side corner. This skill is to be displayed very fast and made opponents encircling very tough.
2. **Back Kick** - This skill is also named as mule kick. In this kick is executed backward like actions of a mule. This skill is very advanced skill and used when opponent coming from behind. This skill requires high control on his speed, because the performer quickly stops and displays the skill

### KABADDI COURT-MEN

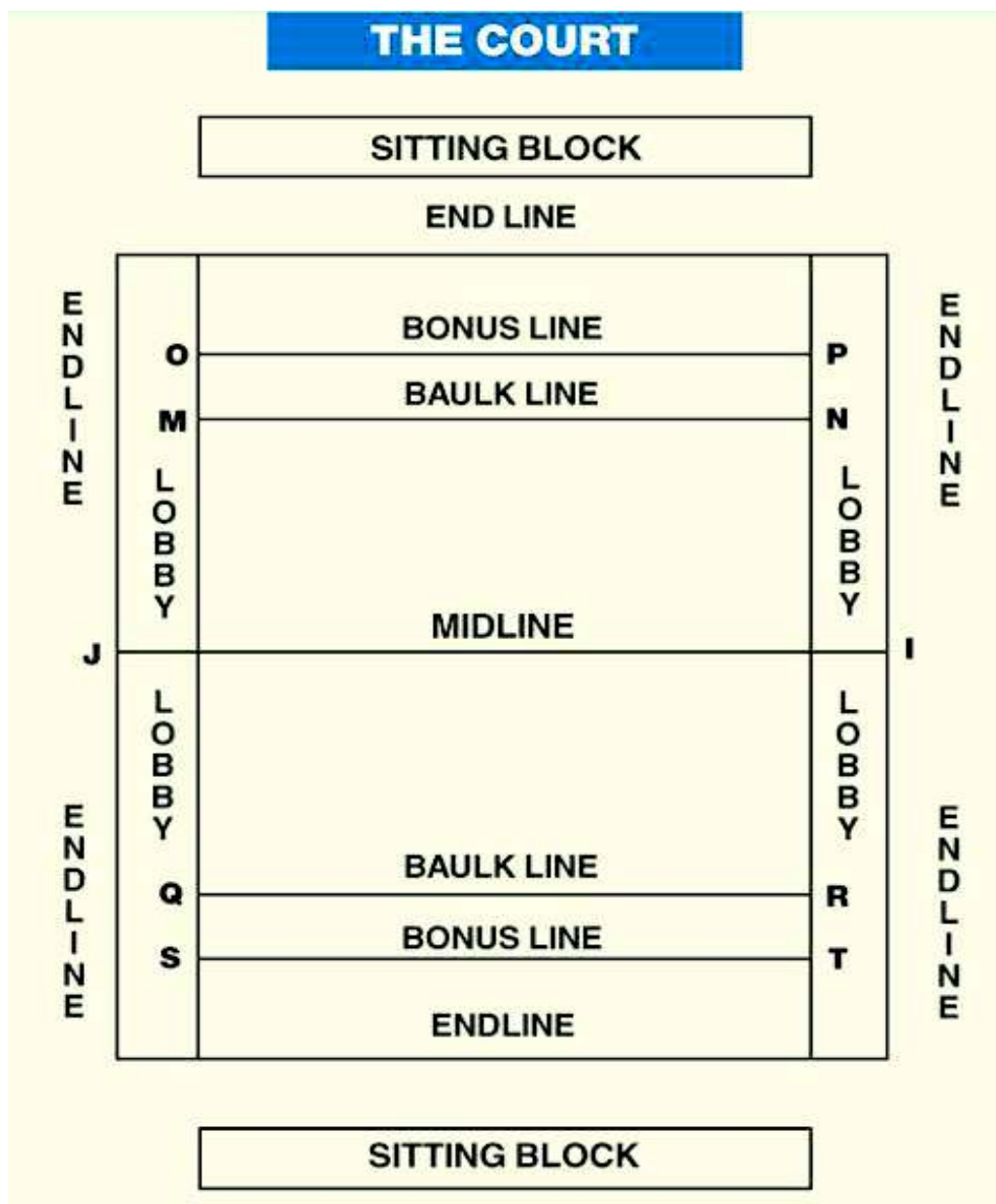

## THE COURT

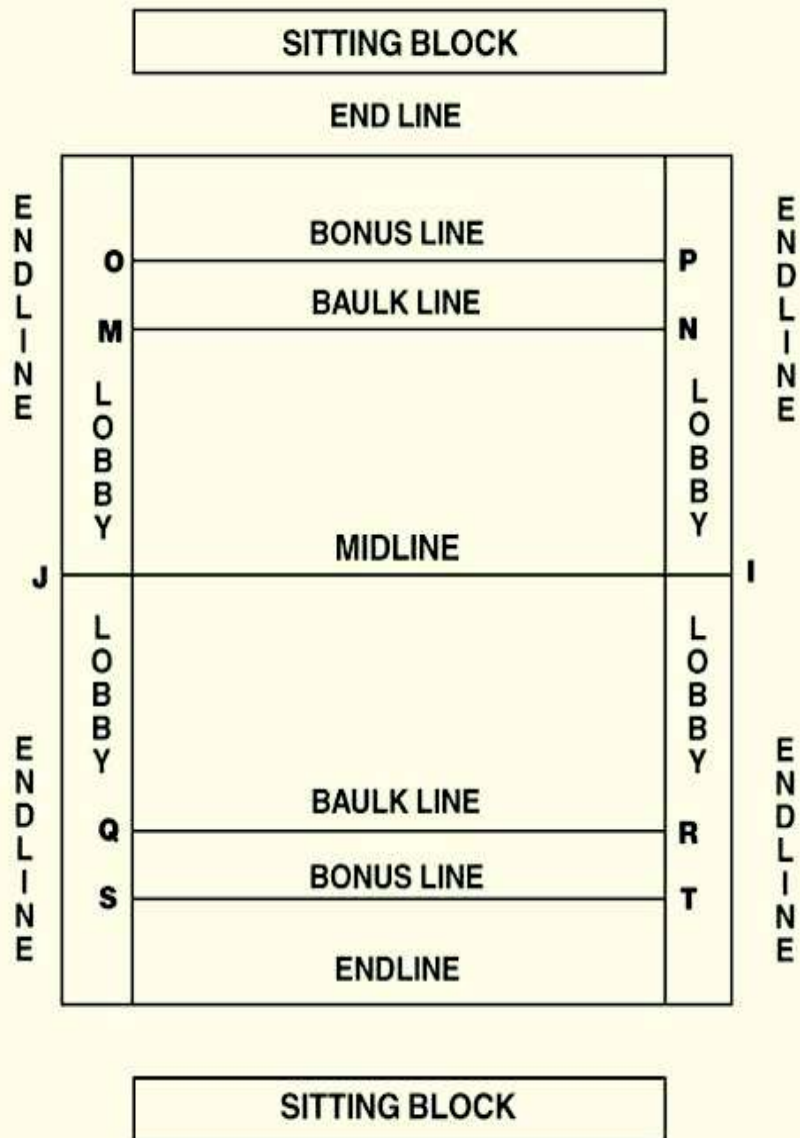

### 3. Use of Toe in Touching

The touching leg is completely stretched and performer tries to touch the opponent or the bulk line with the toe. This skill requires very fast recovery to avoid, to get gripped by opponents

### DEFENSIVE SKILLS

**Ankle Hold-** this skill is mainly an encounter skill of toe touching. When the raider tries to touch the bulk line or the defender by the toe or foot the defender in counter get back or attempt to grip the ankle of the raider. In the skill the raider's ankle held with both the hands and the leg is pulled upward to make to make the raider disbalanced.

**Thigh Hold-**this skill includes the holding of raider's thigh with complete control of the weight of the body. The defender quickly bends down and in a quick attempt with head downward hold the thigh with both arm stretching.

**Waist Hold-**in this skill the defender holds the raider from his waist with both the arms. This skill is performed from behind in attempt to catch the raider with very firm hold. When the raider bend forward to touch the defender then the other defender tries to hold the raider from behind using Waist hold skill.

### RELATED SPORTS TERMINOLOGIES

1. **Ankle Catch:** Technique of catching a raider's leg using finger lock grip.
2. **Raider:** An attacker in the opponent court to touch the player out by uttering, the word Kabaddi Kabaddi
3. **Anti-raider:** All the defending side player are anti, when they try to catch a raider in their own half of the court.
4. **Cant:** Term used for an attackers (raider) repetition of the word Kabaddi-Kabaddi without breathing in.
5. **Pursuit:** To rush in the opponents' court with proper can't with a view to make out to the returning raider.
6. **Flying kick or Aero Kick:** Technique used to touch the defensive players by way of raising the leg.
7. **Lona:** When all the players of a side are out, two extra points, as bonus are rewarded to the opposing team, is known as "Lona"

8. **Waiting Block:** A place marked behind the end line on both side of the play field used to accommodate our players.
9. **Mule Kick:** a technique used by raider by kicking the leg at the back side to make defender out
10. **Catcher:** A defending player, who try to catch the raider.
11. **Squat leg Trust:** a raider's technique of making a defender out by sitting (squat) and stretching the leg quickly.
12. **Safe Raid:** A raid with no intention of making a player out and coming back safely.
13. **Knee Hold:** A defensive techniques of catching the raider from knee
14. **Baulk Line:** A line 3.75m for men and 3m for women away from center line; a raider is out if he fails to enter the opponents baulk line.
15. **Bonus Line:** 1.75 meter inner lines in men's form the end line. Raider scores one point if he crosses it completely provided there are more than 6 players at defending.

## **RULES OF PLAY**

- ❖ The team that wins the toss shall have the choice of the court or the raid and the team, that losses the toss shall have the remaining choice. In the second half, the court shall be changed and the team which had not opted for raid shall send their raider first. The game in the second half shall continue with the same number of players as it was at the end of the first half.
- ❖ A player shall be out if any part of his body touches the ground outside the boundary out during the struggle a player shall not be out if any part of his body touches the ground outside the boundary by keeping contact of the playfield. The portion of contact must be inside the boundary.
- ❖ If any players go out of the boundary during the course of play, he shall be out. The umpire or Referee shall try to take out such players at once. The umpire or Referee shall declare such players out be calling our the numbers. No whistle shall be blown as the raid may continue.
- ❖ If an anti or antis, who have gone out of bounds, hold a raider, the raider shall be declared NOT OUT. The anti or antis who have gone out of bounds only will be declared out.

- ❖ When the struggle begins, the play field includes the lobbies. During the struggle and after the struggle in the same raid, the players involved in the struggle can use the lobbies to enter their respective courts. This rule will only be applicable in the anti's court.
- ❖ A raider shall continue to chant "KABADDI" as the approved cant. If he is not keeping the proper approved cant in the opponent's court, he shall be ordered back and the opponent will be given one technical point and chance to raid. Under such circumstances, he shall not be pursued.
- ❖ A raider must start his cant before he touches the opponent's court. If he starts the cant late, he shall be ordered back by the umpire or Referee and the opponent will be given one technical point & a chance to raid.
- ❖ If a raider goes out to turn, the umpire or Referee shall order him to go back and one technical point will be given to opponent team.
- ❖ Not more than one raider shall enter the opponent's court at a time, if more than one raider enters the opponent's court at a time, the umpire or Referee shall order all to go back to their court and a technical point will be awarded to the opponent and chance to raid
- ❖ After a raider has reached his court or is put out in the opponent's court, the opponents shall send their raider within 5 seconds. Thus alternately each side shall send their raider until the end of the game. In case the raider fails to start his raid within 5 seconds the team loses its chance to raid and the opponent team gets a technical point.
- ❖ If a raider, who is caught by the anti or antis, escapes from their attempt to hold and reaches his court safely he shall not be pursued.
- ❖ If a raider, while in the opponent's court loses his cant, he shall be out.
- ❖ When a raider is held, the antis shall not try deliberately to stifle his cant by shutting his mouth, using violent taking leading to injuries, any type of scissoring or use of any unfair means. If such incident happens, the Umpire or Referee shall declare the raider NOT OUT.
- ❖ No anti shall willfully push the raider out of the boundary by any part of his (Anti's) body, nor shall any raider willfully push or pull an anti or antis out of the boundary. If the raider is pushed outside the boundary or the anti is pushed or pulled outside the boundary, the umpire or Referee shall declare the raider or the anti, as the case may be, as NOT



OUT, and the anti or the raider who pushes or pulls the opponents outside the boundary shall be declared out.

- ❖ During the course of raid none of the antis shall touch the raider's court until completion of the raid. In case any anti or antis touches the raider's court before completion of the raid they will be declared out and the opponent team will be given that many points.
- ❖ If an anti or antis who are out, having violated, holds a raider or have violated the said rule while holding or helping to hold the raider, the raider shall be declared NOT OUT and the anti or antis who touches the raider's court shall be declared OUT.
- ❖ When a team manages to put out the entire opponent team and none of the opponents are entitled to be revived, then that team scores a LONA and two extra points for LONA shall be awarded in addition to the points scored by the team putting out all the players of the opponent. The play continues and all the players who are out shall entire in their court within ten seconds. Otherwise the referee or umpire shall award one technical point to the opponent. If the team fails to enter within one minute, the team shall be scratched from the match and the match shall be awarded to the opponent.
- ❖ If a raider is warned or in any way instructed by one of his own side, the umpire or referee shall award one technical point to the opponent.
- ❖ A raider or an anti is not to be held by any part of his body deliberately other than his limb or trunk. The one who violated the rule shall be declared OUT. If the raider is held deliberately other his limb or trunk, the Umpire or referee shall declare such raider NOT OUT.
- ❖ When one or two players of a team are left during the game and the captain of the team declares them out in order to bring in the full team (the opponent shall score as many points as the players that existed in the court at the time of declaration as well as two extra points for LONA.
- ❖ A player or players who are out shall be revived in the same order as they were out when one or more opponents are out.

## **RULES OF MATCHES**

### **1. Team**

Each team shall consist of minimum 10 and maximum 12 players. 7 players shall take the ground at a time and the remaining players are substitutes.

### **2. Duration of the Match**

- ❖ The duration of the time of match shall be two halves of 20 minutes in case of Men & Junior Boys with 5 minutes interval. In the case of women, Junior Girls, Sub-Junior Boys & Girls two halves of 15 minutes with 5 minutes interval. The team will change after interval
- ❖ The number of players for each team at the start of second half shall remain the same as it was at the end of first half.

Note: The last raid of each half of the match shall be allowed to be completed even after completion of the scheduled time as mentioned above.

### **3. System of Scoring:**

Each team shall score one point for every opponent out or put out. The side which scored a LONA shall score two extra points. The put out and revival rule will be applicable.

### **4. Time Out**

- ❖ Each team shall be allowed to take two “Times Outs” of 30 seconds each in each half; such time out shall be called for by the captain, coach or any playing member of the team with the permission of referee. The time out time shall be added to match time.

#### **Check your progress**

Notes : a) Write your answer in the space given below

b) Compare your answer with the those given at the end of the unit

5. Describe a few merits of single knockout or single elimination

-----

4. Draw a model ball-badminton court in the space provided

### **2.11. Let us sum up**

The present unit attempts to provide the basic concepts of teaching of physical education. It also briefs about the various methods of teaching physical education at various levels. Further it describes the tournament, types and few regulations with suitable methods of teaching

### **2.12. Unit end activities**

1. Tabulate the minimum difference between intramural and extramural competition
2. Construct a model lesson plan by adopting a suitable method of teaching physical education

### **2.13. Answers to check your progress**

1. Refer your answer with the material provided in this unit.
2. b
3. d
4. Check your answer by comparing the right answer provided in this unit
5. Check your answer by comparing the right answer provided in this unit
6. Check your answer by comparing the right answer provided in this unit

### **2.14 Suggested Readings**

1. Bucher Charles. A."Foundations of Physical education"8<sup>th</sup> Rd., The C.V.Mosby Co.St.Louis, 1979
2. Dash.B.N "Health and Physical education", Newdelhi, Neelkamal publications,2007
3. Nanda V.K."Health education", An mol publications Pvt.Lts. New delhi, 1997

## UNIT –III

### CONCEPT OF HEALTH EDUCATION

#### 3.1 Introduction

Any system of Physical education without the support of health education cannot possible accomplish the best rules. The mutual coordination of physical and health education is a matter of fundamental importance in any system.

#### 3.2 Objectives

After learning this unit, you will be able to:

- Understand the concept of health education to human kind
- Know the aims, objectives and importance of health education
- State the health education in schools and to organize the health service at the school
- Identify the concept of safety education with reference to home, school and environment
- Apply the skills of first aid to athletic injuries

#### 3.3.1 Meaning

Health Education is concerned with promoting health as well as reducing behavior induced diseases. In other words health education is concerned with establishing or inducing changes in personal and groups attitudes and behavior that promote healthier living.

#### 3.3.2 Definitions of Health Education

Health education as the sum of experiences, which favorably influence habits attitudes and knowledge relating o the individual community and social health.

**-Thomas wood**

Health education like general education is concerned with changes in knowledge, feelings and behaviour of people. In its most usual form it concentrates on developing such health practices as are believed to bring about the best possible state of well being.

–W.H.O technical Report (1954)

### 3.3.3 Aims of Health Education

The following are the some of the main aims of health education

- a. To provide information about health and its value as community asset – Health education aims at acquainting the etchers with the rules of health and hygiene. Functioning of Precautionary measures to ward off diseases and to provide good disease free working conditions.
- b. To maintain norms of good health: The authorities should provide hygienic environment in the form of adequate ventilation proper temperature, good sanitation and all round cleanliness. It helps the authorities to keep certain norms of health.
- c. To take precautionary and preventive measures against communicable diseases. Its aim is to take adequate precautions against contamination and spread of diseases. Thus good sanitary arrangements are made. Precautionary and preventive measures. If they are properly adopted can help in improving the health standards of society.
- d. To render assistance to the school going children an understanding of the nature and purpose of health services and facilities – It aims at discovering physical defects and other abnormalities in the child and promoting their reduction if they are easily curable.
- e. To develop and promote mental and emotional health – mental and emotional health are also equally important along with physical health. While physically health makes a pupil physically fit mental and emotional health enables him to maintain an even temper and a happy disposition
- f. To develop a sense of civic responsibility. School is a miniature society Responsibility of skill health does not lie on any one's shoulders. Even some cause of skill health has their origin in social conditions which require action on the part of community as a whole in

order to eradicate them. It aims at realizing the people to make combined efforts and work for community health.

### **3.4 Objectives of health Education**

The following are the comprehensive list of functional objectives of health education to be adopted in schools

1. To enable the students to develop a scientific point of view of health with reference to traditional and modern concept of health.
2. To enable the students to identify health problems and understand their own role on health and to medical agencies in meeting those problems
3. To enable the student to take interest in current events related to health
4. To enable the students to arrive at suitable conclusions based on scientific knowledge and take action as an individual member of the family and community for protecting maintaining and promoting individual and community health.
5. To enable the students to set an example of desirable health behaviour
6. To enable the student to understand the causes of the pollution of air water, soil and food as well as their ways and means of prevention
7. To enable the students to gain sufficient knowledge of first aid
8. To provide desirable knowledge about marriage sex and family planning to the students
9. To help students to understand the importance of Physical training sports, games, yogic exercises as well as their relationship with health education programme.
10. The emphasize students on the bad effects of smoking and taking alcohol etc
11. The acquaint students with the functioning of various organizations working for the maintenance of health.

12. To help students understand how the present day rapid development of science and technology has increased the hazards of life and health problems and also how to face and prevent them.

### **3.5 Importance of Health Education**

“This atma is not attainable by a weak man.” –*Swami Vivekananda*

“The first wealth is health.” – *Emerson*

If health is so precious an asset then education of health is indeed, more important. Health education helps us in following ways

1. Health education provides information to the students and the teachers about the function of the body, the rule of health and hygiene and precautionary measures for keeping of diseases.
2. Health education helps in discovering physical defects of children and discovering various types of abnormalities of children
3. Health education develops health habits like need of fresh air, hygienic feeding and various class room habits
4. Health education provides knowledge regarding good health habits
5. Health education develops better human relations between school, home and community
6. Health education provides knowledge regarding prevention and control of various diseases
7. Health education provides first aid training essential for everyone as an emergency may come to any one and at any time.

### **3.6 Health Education in Schools**

Programme of health education should not confine itself to personal hygiene of pupils only. It should include all aspects which may help in promoting health of the community as a whole. A school programme is twofold.

- (i) Prevention of the development of poor health

(ii) Preservation of good health

The school health program is divided in to three parts

1. Health instruction
2. Health service
3. Health supervision

## **HEALTH INSTRUCTION**

### **Introduction**

The school has major responsibility in the area of health instruction. It should instruct youth in such things as the structures and functioning of their bodies the causes and methods of preventing certain diseases, the factors that contribute to and maintain good health, and the role of the community in the health program. Such an instructional program if planned wisely and taught intelligently will contribute to good health habits and attitudes on the part of the student.

Health instruction should avoid too much stress on the field of diseases and medicine. This is pointed out by Dr. Baue health authority in an article entitled Teach health Not Disease. He says that teachers should primarily teach health how to live correctly and how to protect one's body against infection rather that teaches diseases and medicine. Proper health instruction should impress upon each individual his responsibility of his own health and as a member of a community for the health of others

### **Definition**

Health instruction is that organization of learning experience directed towards development of favourable health knowledge attitude and practice. – **D. K. Barle**

### **Aim**

The aim of health instruction is to acquaint pupils about the functioning of the various organs of the body the rules of health and hygiene and methods for curing diseases.



## **Methods of imparting health instructions**

There is nothing very special about the methods of imparting health Education. Health Education forma an essential part of total education. As such all aspects of health education should be carried on at all stages of the educational process according to the age and maturity. The following are some of the important ways and means through which health education and its instruction can be imparted effectively in institutions.

### **1. Healthful Environment of the institution**

Environment is the most important of all educational media. Any scheme of health education must receive top priority to the improvement of physical and human environment. Neat clean attractive and well maintained institutional building, classrooms, equipments and plays fields, sympathetic and affectionate teachers contribute greatly to inculcate healthful living, health habits and conditions of work and health notions about work and life. As is the environment. So is the individual therefore healthful environment of the institution plays key role in achieving success.

### **2. Systematic Health Instructions**

Direct health instruction should be provided through subjects like hygiene, physiology, general science physical education home science social studies etc. This will enable students to understand the structures and function of human body realize the need for keeping physically fit and take precautionary and remedial measures in case of illness and diseases. Such instruction will also lay emphasis on physical exercises, sports, games and nutritional value of different kinds of food and diet.

### **3. Incidental Teaching**

At the school stage the teacher can give health instruction in the class room situation when there is any incident of communicable disease in the school. In this way such incidental teaching may benefit the individual or the entire class. Similarly teachers have opportunities to give instruction off and on, on personal hygiene in a simple language which is benefit at for the school and community as a whole.

#### **4. Lectures on health by experts**

The school authorities should make arrangement on certain occasions to request medical officer or physical instructor and other experts on health to visits the school and to deliver a lecture on various items o health and hygiene. However emphasis should be laid on the fact that talks should be supplemented by illustrative aids and material. At the end of the talk the pupils must be given opportunities to ask any questions concerning the topic to get their doubts cleared.

#### **5. Printed Material**

The school can accumulate printed material on health and hygiene such as short leaflets, pamphlets posters and standard books. Even the school authority can have the material from the local health department to highlight certain diseases, their causes and cures.

#### **6. Films and Film Strips**

The school can arrange documentary film from various sources which generally displayed the various diseases and how to prevent ourselves from these. They also stress the importance of personal habits like cleanliness. Similarly film strips accompanied by talks or commentary by experts can be displayed and may be retained on the screen as long as wishes.

#### **7. School broadcast and radio talks**

Radio talks are a powerful medium for giving health instruction to the young pupil and reaching a wide public at the same time. Radio talks can be delivered on problem of health and hygiene by way of songs or play. In this way the children not only get entertainment but useful instruction also similarly the school broadcast programme does include items of health and hygiene.

#### **8. Educational field trips**

Actual field trips provide learning situation for the children and they can get firsthand experience. Such trips include visit to red cross hospitals. Clinics, fairs exhibitions, yogic centre public health centre and water supply centres etc. however each visits needs proper planning and advance class room discussion to motivate young children. At the end of visit if the teacher clarifies the doubts of the students it will be more beneficial for the children.

## **9. Health Weeks**

It is a good method of imparting health instruction to the young pupils. Health week may be celebrated in the school every year in which emphasis is laid on personal hygiene and upkeep of the school campus. Special talks by the expert may be arranged on personal hygiene and sanitation.

## **10. Health Club**

Each institution should organize a health club as self governing unit. Through this club the students can be associated with institution health laws and their administration. They can also be encouraged to practice health rules in their daily lives. These clubs in co-operation with the institutions Red Cross society should arrange debates declamations plays and dramas on makers concerning health.

## **11. Health Scrap Books**

Students should be encouraged to maintain scrap books on health on the top of every page one important health rule should be written or pasted. Pictures illustrating important health rules, causes and prevention of various disease neat and healthy living functions of various organs in human body should be collected this book should contain the records concerned with the students.

## **HEALTH SERVICE**

The health service programme includes different protective measures to maintain and improve health. Ultimate goal of the institutional health services programme is the attainment of physical mental and emotional health of every students to the optimum experience for students leading them to adopt desirable health habits.

The quality and the quantity of mental work depends upon the conditions of human body. It is not in proper order, optimum output cannot be expected.

## **Aim**

Health services aim of the locating ill health and provide medical care after proper medical checkup.

Agencies of school health services

1. School Medical Department under the charge of a school Doctor
2. School health Educator
3. School Dispensary
4. Red Cross unit of the School
5. Sports Department under the charge of a qualified physical education instructor

## **3.7 Programme of health Services**

In order to ensure normal and sound physical condition of the students, the institutions should establish certain organized services and the programme should constitute.

### **Medical Inspection and maintaining Records**

- Proper arrangements in the school to get every student medically examined at the time of his first admission to the institution and in subsequent years
- Periodically arrange for health inspection of the pupils with regard to vision hearing dental health and personal hygiene.
- Maintain the records of medical inspection and health status of the children
- Promote the importance of vaccination and immunization to parents of wards.
- If any dangerous disease is identified the school authorities should proper steps and suggest the parents of wards to consult the experts in the hospital.

## **2. Duties of teachers**

- Observation by the teacher and experts to locate defects and disease if any especially of skin, eyes, ears, teeth etc in the wards inform in the parents for speed recoveries.
- In addition teachers should look at the child's posture. Cleanliness and hygienic conditions. If they observe any deformity or diseases in the pupils they must inform the school doctor and check that the treatment at the clinic is carried out whole time dispenser should be appointed for the school clinic or dispensary where children may be given proper first aid and medicines for small diseases and for some ailments.

## **3. To maintain sound health condition**

- Maintain proper sanitation conditions of the school
- Highlight the importance of sanitation to children
- An arrangement in the school for first aid emergency treatment when he child receives injuries while playing or is suddenly ill.
- Record the history and defects of special cases

## **4. School clinic**

- A school clinic or dispensary needs proper care and should be equipped with medicines for ordinary aliment dispensary tables, chairs, charts and models concerning health, bed for the sick of patients, scale for measuring height, covered dustbin, heater and first aid boxes etc.
- A school clinic helps in looking after the health of the pupils and for the systematic treatment of small diseases. There should be at least two rooms for school clinics or dispensary out of which one should be reserved for the school doctor were the pupils consult the doctor about their personal problems

## 5. Follow up work

- Head of the institutions may arrange for timely vaccination against small pox and typhoid so as to reduce outbreak of these infectious diseases.
- If some students have some contagious disease like ring worm eczema or leprosy precautionary measures should be adopted till they are cured of such diseases
- The health status of the students reading in the school should be appraised annually
- The physical defects of the children should be corrected All the students of the school should get the benefit of school health counseling
- The guidance personnel physicians school health educators and the teachers should interpret to student and their parents the nature and significance of health problems and help them in formulating plans of action leading to the solution of the problems of the students.
- Should be provided for a single or a system (group) of schools.

### Check your progress

Notes : a) Write your answer in the space given below

b) Compare your answer with the those given at the end of the unit

1. 'The first wealth is health' is proposed by

a) Swami vivekananda b) Emerson c) Thomas wood d) W.H.O. Report

( )

4. The school health programme refers..

a) Health instruction b) Health service c) Health supervision d) All the above

( )

### **3.8 SAFETY EDUCATION**

#### **Meaning of Safety Education**

Safety education is an important device to control and prevent accidents. It has been shown repeatedly that there is a need for cooperative action in safety education whether it be in school playfield road and home.

#### **Importance of Safety Education**

Safety education forms an integral part of health education. In the modern civilized world through man is able to conquered space and time, he has not yet conquered risks and dangerous to life. Man's utmost desire is to live comfortably. Electricity has become an unavoidable necessity in providing convenience and comforts. But the slightest care lessness in dabbling with it costs life. With a desire to save time he has adopted a speedily life. Luxury has enslaved him. The fashion of sing speedy vehicles forces him to entangle in dangers. Speed has become a religion.

Every day the loss of life is untold due to carelessness in every walk of life. Artificial life is closely associated with risks and dangers and at every moment he has to be alerts to maintain safety. Thus safety education forms an integral part of health education. Safety education has to be taught to children. They should be trained to avert and avoid risks and dangerous instead of inviting them through carelessness.

Many of the risks hazards and dangers can be averted at home school and play fields if the teachers and parents take due care of the child. Children by nature are always knotty and mischievous. They go about tampering with things not knowing the risks involved in them. Both at school and at home all electrical appliances should b kept away from their easy reach and they should never be allowed to operate on electric switches.

The gardens and lawns at home and the play fields should always be maintained well and should serve as secure places ensuring safety. Until children learn to be safe, they should be watched very carefully at home, school and playfields. These are the places to be taught and trained to be safe. Hence safety education should find its place as a classroom subject to be taught along with health education.

## **A. Safety At school**

Students spend most of their time in schools. During leisure hours they get opportunities to get them involved in such activities which may lead to accidents. To make the school life safe safety education should be included in the curriculum.

### **Classroom**

- Congestion of benches and tables in the class room should be avoided. There must be sufficient elbow space for the student to move about in the classroom. Broken furniture must be removed.
- Classroom should prove to be the safety place for every pupil to sit at ease and listen to lectures. Any inconvenience in enjoying the comforts of sitting at ease is likely to disturb his concentration
- All the walls should be white washed and there should be proper ventilation in the classrooms
- Glass fitted to the windows should be highly fixed and there should be no broken places hanging over anywhere.
- Sharp edges of the walls pillars and door are always dangerous out children when they take sharp turns may dash against them.

### **Laboratories**

- The laboratory rooms must be comparatively big In addition to the big room where experiments are performed a lecture theater one attache's store room and one preparation room should also be provided.
- There should be proper arrangement for ventilation and light in the laboratories and the lecture hall.
- Wall almirahs and cupboards for keeping apparatus and chemicals safety.
- Proper arrangement of gas burners spirit lamps.



- Proper arrangements of water sink and tap.
- Care in the use of equipment of chemicals.
- Aquarium for keeping fish and water plants and a germination bed.
- In home science lab, separate rooms for kitchen, laundry sewing and first aid are provided.
- Students should water proper glass during the operation of computer.
- Switch boxes under the computer table.
- The laboratories where breakages of glass vessels are common: the floor and the works table should be kept with perfect cleanliness. All bottles with poisonous chemicals should be labeled in bold letters.

### **Play Ground**

1. Play areas should be fenced properly avoiding barbed wires.
2. During Physical activity classes students should wear suitable dress.
3. Warming up exercise is essential before indulging in any vigorous activity.
4. Playing equipments should be checked.
5. Students will be divided in the groups then only play the activities.

### **Student's role**

- Areas outside the class room building and inside the classroom should be kept clean.
- Avoid pushing shouting and running in the school building.
- Go through doors carefully.
- Know the location of exits and fire escape.
- Don't play inside the class room.

The attitude of the children is not totally free from mischievousness. As such livewire laying any where uncovered switched and broken parts of electrical installation exposed anywhere are tempting ones for the children to meddle with. Therefore instead of instructing them to keep off from them immediate attention may be given in rectifying and restoring them to order.

### **Teacher's role**

- To approach psychological problems among the students regularly.
- To explain how to follow the rules and regulations in the classroom laboratory and play ground.
- To provide knowledge related to medical inspection rules and regulation of sports and games.
- To maintain proper disciplines in the class.

### **Facilities**

- Classroom drinking water, sports, bathrooms, lavatories urinals and all the surroundings areas inside the school compound should prove to be safe.
- Staircase should not be too high or too steep. They must be broad to and on rush at times and should have side support to a reasonable height.
- No child sits in the class permanently He moves from place to place during recess and leisure time. To ensure safely all places should be free from obstructions.
- The parape walls should be as high as possible./ The cement flooring should not be too much polished. When children move fast there is very likely hood of their falling down Such falls may result in heavy damage to the clinic.
- Drinking water areas should not be marshy slushy, muddy and slippery.
- The urinals and flush out should always be kept clean.

- Fire extinguishers are to be fixed to the walls at place where fire can breakout or where there are inflammable substances.

## **B.Play Ground**

### **Play Area**

- The field must be clean and articles like broken glass nails small pieces of stones and other harmful articles must be removed from the field and rectified through periodic inspection.
- Play grounds are not made in a day or two continuous attention and mending render the fields playable.
- Space between courts is essential.
- In marking the play areas instead of chunnam it is usually the practice to the ropes. This is not safe during the act of play. There is every likely hood of the players moving out of the court and getting trapped or stumbled. This may result in causing damage to the players.
- Safety measures should be made available to prevent the fall of fear or injury and to encourage optimum performance.
- Pupils should be advocated well to keep off the grass not to cut across the ground facilities and not to misuse the play fields.
- Play areas should be fence properly avoiding barbed wires.
- Care should be taken to keep the grounds smooth with a good grading for free flow of water to the drains at rains.
- Students should not be allowed to remain under the sun for a long period of time. There must be provision for rest shade to help the student to take rest for some time.
- First aid facilities should be made available as close to the play field as possible.

- Drinking water must be available.
- Posts should be printed with white paint.

### **Equipments**

- Always check the equipment before working class
- Place the equipment in suitable storage container such as trolleys bags or boxes
- Anklets must be used by the students while playing some games like foot ball
- Teacher should train the students in the use of different equipments so that the participants will be able to play efficiently with those equipments for examples while playing with the equipments like cricket balls. Short put, javelin etc they must know how to save themselves from accidents and injury.

### **Rules and Regulations**

- In the game of foot ball kicking tripping (even attempts) pushing an opponent or jumping at him as also pulling an opponent bodily or by his shirt constitutes foul play. To charge dangerously or to injure a player is bad out. As a safety measure players should be advised not to adopt bad fouls.
- Players must know what they are going to do and they should do different activities while participating in games They must be sure of the rules of the game and how to obey them.
- Teacher should make the students know rules of the game before attempting to teach it.
- Students who follow strictly the rules of game should be rewarded. However when a boy hits another students the teacher should tell him to stop.
- Teacher should carefully evaluate the situations in the field and discuss with the students above their activities.
- We must be sure that the teachers assisting the programming of games are aware of the safety factors involved in the game. They should play the role of supervisors

- In order to avoid accidents in the field the teacher should use some tone of voice each time he speaks to the students as a major clue to his feelings towards the players thus he can avoid danger in the field.

### **Swimming Pool**

- Children should be allowed in such swimming pools where the water level is not so deep.
- At the time of swimming certain principles must be followed by the swimmers.
- They should wear minimum clothes so as to save themselves from accidents.
- Children suffering from skin diseases should not be allowed to use the swimming pool.
- Provision must be made recruit supervisors to look to the safety of the individuals who use the swimming pool.
- There should be provision for first aid box to provide immediate help to those who met with accidents.

### **Gymnasium**

- The participants should strictly obey the rules and regulations for different gymnastic activities.
- All gymnastic activities should be conducted under the strict supervision of a trained physical education instructor.
- Learning of exercises should progress from simple exercises to difficult exercises.
- The students should be advised to wear gymnastic shoes. It will help the students to escape from serious accidents in the gymnastic programmes.
- Exercises must be conducted according to fixed time.
- A large mat should also be placed under the flying rings.

## **B. Safety at Home**

### **Kitchen**

- It is essential to know the techniques of operating the stove safely where the fuel used is wood, coal, kerosene, gas or electricity.
- When gas is used the valve on the cylinder should be closed when not in use.
- The kitchen floor should be dry free from grease, skins of fruits and vegetables otherwise there is a chance of slipping the cause a fall.
- When cooking it is dangerous to wear synthetic dress.
- All sharp instruments such as can openers can knives should be stored in a drawer and immediately after the clearing they must be put away safely.
- Pressure cookers should be used as per the manufacturer's direction.
- During operating the oven should not stand in front of the oven.

### **Bathroom & Bed Room**

- Electric switches and plug points should be fixed on the walls at a height above the reach of children.
- Minimum wattage bulbs should be used.
- Mosquito mats should not be kept in near beds.
- Bath room should be kept clean.

### **Children**

- Children should be given proper training in the handling of electrical appliances except electric switches.
- Children are under the care of their parents at home parents have to educate the children to gain sufficient knowledge to keep themselves safe at all times.

- Children at home cannot confine themselves to studies at all hours.
- No child should be prevented from playing.
- Playing in the street should never be encouraged parents should be vigilant in keeping the gate closed and see that the children are always in door.
- Children should not be allowed to go alone to the upstairs of the buildings.
- The flooring of the bathroom and the lavatory should not be slippery.
- Electric switches and plug points should be fixed on the walls at a height above their reach.
- Children should never be allowed to handle electric items such as iron box, electric stove, mixer, grinder etc.
- Sharp instruments such as knives scissors, vegetables cutter etc should never be made available to them.
- Children should never be allowed to go near the electric stove, mixer or grinder.

### **Parent's responsibility**

Parents at home have total responsibility in looking after the safety of the children

1. Advise them to wear cotton clothes.
2. Keep away the drugs chemical substances safely from the reach of the children.
3. Do not allow children to play near the parked cycle and motors.
4. Give proper guidance to close and open the door.
5. Windows should be opened for ventilation.
6. If not in use turn off the gas cylinder.

Bleeding, bruises, dislocation tearing up of muscle, breaking of bones, heavy hemorrhage and several other complications take places in their children for want of carefulness of the parents.

### **C. Safety on the road**

Accidents on the roads have become very common in the modern society. Due to speed and increase in the number of automobiles, road accident occurs almost every day. School children who are not aware of the traffic rules meet with accidents. Safety their measures can be successful if we taken in to consideration either problem of the road.

The following safety measures are taken into consideration to avoid accidents.

#### **Road cleanliness**

- Keep the road clean, do not throw garbage on the road
- Do not cause any breakage on the road
- Do not use crackers on the road

#### **Rules & Regulations**

- The instructed boards which gives message giveaway to entry one way et should be placed wherever it is needed
- To avoid accidents pupils should follow the rules and regulations of road
- Children do not play on the road playing cricket ball or playing kite on the road
- The students should learn how to obey the traffic light signals and the instruction of the traffic police
- While crossing the busy road they should be very careful when they feel that the road is free from danger only then they should cross it.

#### **Safe Dividing of vehicles**

- While driving automobiles the driver should be very careful and should follow traffic rules.
- Accident can also be avoided if the driver and vehicle operator keep off highway



- Driver should avoid alcohol.
- The driver should be aware of the safety driving rules.
- The driver should see that the vehicle is well equipped with indicators break light, horn and other important materials.
- The number plate of vehicle the mirror etc should be visible to the people.
- The automobile driver should be aware of the all India road signs and drive carefully according to the sign.
- He must know the mandatory sign of schedule of the motor vehicle act.
- The women should wear proper dress during riding.

### **Pedestrian**

- Look at the signals at every crossing.
- Pedestrian should be aware that they must take on path way while walking keeping an eye on the road.
- While crossing the road they should move straight looking to the both sides of the road and avoid reading and thinking.
- They should be aware of drainage system

### **Role of government**

- Rules and regulation awareness camp should be organized by the government.
- To celebrate road week day celebration.
- Govt. should conducted drug addiction awareness camp among the drivers.

**Check your progress**

Notes : a) Write your answer in the space given below

b) Compare your answer with the those given at the end of the unit

3. Safety education includes...

a) Safety at school    b) Play ground    c) safety at home    d) All the above    (    )

4. write a short note on safety on the road

**3.9 ATHLETIC INJURIES AND FIRST AIDS****Athletic Injuries****Introduction**

Every day millions of people (of all age) in the world participate in games and sports activities. Participation in sports improves physical fitness coordination and self discipline and gives children and adults valuable opportunities to learn team work, Games and sports sometimes may also result in injuries some of which are minor some are serious and some other are so serious which may require lifelong medication.

The common types of sports injuries are

1. Exposed injuries or open wounds
2. Unexposed injuries or Internal injuries

Conveniently injuries may be further classified into

1. Soft tissue injuries Skin muscle and fascia
2. Bone injuries –Fracture
3. Joint injuries –Dislocation

## **Exposed Injury**

Any injury that is external in nature and visible to the naked eyes is known as exposed wounds.

**Eg:**

1. Abrasion
2. Laceration
3. Punctured wounds

### **Definition:**

An abrasion is a scarping injury to the skin by which a loss of epidermis and dermis in the skin takes place

**Causation:** A sudden fall on the hard surface and slide

### **Signs and Symptoms**

It is extremely painful and blood may ooze from injured capillary vessels to the surface. The wound does not penetrate completely through the skin

### **Treatment**

Clean the skin with soap and water .The soap acts as solvent for grease and embedded dirt. Washing can be done with a soft brush to remove the ground dirt and any other foreign material.

- Tincture of benzoin may be applied to reduce pain.
- An antibiotic ointment like furacin may be used.
- A suitable dressing and gauze with adhesive tape to prevent reinjure must be done.

## **2. Laceration**

### **Definition**

Laceration is a separation of the skin an irregularly torn wound with sharp edges of objects. The wound may occur to the skin subcutaneous tissue the underlying muscles and associated nerves and blood vessels

### **Causation**

- # A direct contact of sharp instrument or implement.
- # Signs, symptoms and damage.
- # The word may only the tearing of the skin or damage subcutaneous tissues, the underlying muscles and associated nerves and blood vessels. Pain and bleeding take place.

### **Treatment**

- Clean the area with soap and water
- Remove the pieces of torn tissue from the wound
- Clean with antiseptic (Dettol) If cut is deep suture the wound
- Apply hydrotherapy once daily a week
- Do not use adhesive tape to bring edges of the wound together

## **3. Punctured Wounds**

Usually it occurs while playing or doing physical activities. This is caused by projectiles or pointed objects like spikes splints studs (football shoe) javelin etc. Direct penetration of tissues by these types of pointed objects is called punctuated wounds. There is a possibility of the tetanus bacillus infection. When left careless it makes the athlete or individual to be a victim or lock jaw.

## **Treatment**

Deep lacerations and punctured wounds are to be referred to the physician immediately. Using a ring pad put a bandage around the wound and take the injured to the nearby physician. If any implement or piece is left inside the wound do not try to remove it.

## **Unexposed Injury**

Even though the injury is factored by an external force which does not affect the epidermis but causing internal injury. This is known as unexposed injury. Eg: Sprain, strain fracture.

### **(i) Sprain**

#### **Definition**

Sprain is an injury to a ligament resulting from over stress. A sprain is usually produced by twisting or stretching it beyond its normal range of motion stretching or tearing some of the supporting capsule and ligaments. Sprain is a partial dislocation. Sprain is a muscular skeletal injury.

#### **Categories of Sprain causation**

According to the severity of injury there are three types of sprain

##### **Mild (First degree)**

This is a sprain in which some fibers of alignment are torn with little hemorrhage. There is no functional loss and the ligament is not weakened.

##### **Moderate (Second Degree)**

A moderate sprain is one in which some portion of the ligament is torn and some of functional loss is present. There may be tearing of small portion of ligament. There may be mild functional loss or severe complete functional loss of ligament.

### **Severe (third Degree)**

In severe sprain the ligament is completely torn from one or the other of its attachments with separation of end or pulls it apart within its substances.

### **Signs and Symptoms**

- Pain and tenderness around the joint increased by movement
- Swelling around the joint followed later by bruising and later discoloration
- The joints lose power of movement
- Severe pain is experienced in that part
- The colour of the skin changes
- Inflammation appears on the affected part

### **Treatment**

1. The affected parts should be given complete rest and movements should be stopped for some days.
2. The affected part should be thoroughly massaged with mustard oil.
3. The affected part should be tightly bandaged and put in ice water.
4. If the above treatments do not relieve pain the sprained part should be washed with hot water. This is likely to reduce the pain.
5. Rest and support the injured part in the most comfortable position for the causality elevate an injured limb.
6. Carefully expose the joint and if sprain is of recent origin apply a cold compress to reduce swelling and pain.
7. If the patient has no relief the bandage should be removed and retied.
8. The sprained part should be given complete rest.

9. In doubtful cases treatment should be as for features.
10. If it is a ligament of the arm the arm should be carried in a sling.

## **(ii) Strain**

A strain is a sudden twist pull or tear of a muscle or tendon.

### **Signs and Symptoms**

1. Severe pain bruising and inflammation.
2. Non functionality of the joints.
3. Swelling discoloration of the injured place.
4. One may hear snap sound when the tissue tea.
5. Loss of function of the part affected.
6. A sharp pain at the moment of injury is felt.
7. Raise in the temperature.

### **Treatment**

1. Take complete rest.
2. Apply cold compression bandage and ice pack around the injured place for about 24 hours.
3. Apply hot water fomentation or contrast bath.
4. Call physician help if pain persists.
5. Contusions

Contusions are actually brushing of the tissues and are caused by a direct blow by a blunt instrument or by crushing.

## **Definition**

An injury pressure or a fall causes the blood vessels beneath the skin to break as the result of which the injured part turns blue.

## **Signs and Symptoms**

1. Blood vessels in the underlying tissues are torn and bleeding takes place.
2. Swelling and pain develop in the area which may be superficial or deep depending upon the type of object striking the blow.
3. The blood gradually moves towards the skin and causes discoloration with black and blue mark.
4. If more damage is caused in the tissue and large blood vessels are damaged more blood is collected at the site of confusion and it is called hematoma or blood donor.
5. When fracture of a large bone like femur happens more than a liter of blood collects.

## **Treatment**

1. Arrest bleeding by the application of cold and pressure bandage in the early stage for 12 hours. Immobilize the part and protect to prevent further injury.
2. If the damage is serious with a fracture splinting is needed to control bone injury.
3. Fomentation is also beneficial.
4. The injured part should be given sufficient rest.

## **Classification of Contusions**

1. Simple or superficial confusion
2. Muscle contusions
3. Joint contusions
4. Visceral Contusions



## **Simple Contusion**

In simple or superficial contusions may not cause much damage. But the loss of function is felt in all contusions of joints muscles and visceral which may need immediate attention. Immediately following the trauma there is acute pain and loss of function of the part affected. If the contusions is not severe in degree there may be partial recovery of function in a few moments but this is followed shortly by more pain and further loss of function. In the course of few minutes swelling appears and results in the hemorrhage of the ruptured capillaries.

## **Muscle Contusion**

In simple muscle contusion there is collection of blood between the two layers of skin.

## **Signs and Symptoms**

1. Swelling
2. Pain
3. Discoloration of blood from red to bluish black
4. Tenderness

Complications of Muscle contusion are myositis ossificans traumatic caused by deep muscle contusions. Several periosteal cells are loosened by trauma and clot with the hematoma. Eventually during the process of repair, these cells lay down calcification in the hematoma. Most contusions that fail to be healed in a normal period of time may give indications that the part is affected. It will occur in the origin or insertion of the muscles about joints.

## **Joint contusions**

Contusions to a joint are possible in all sports activities which consist of pathologically bruised joint capsule with a tissue response to the injury of hemorrhage often from results within the capsule well bleeding internally into the joint as well as in to the particular tissues.

## **Bone contusions**

In the type of contusions severely depends upon the intensity of the blow. Blood and lymph collect between periosteum and the bone marrow.

### **Treatment**

1. Control hemorrhage by the applications of cold and compression bandage
2. Apply massage up to 36 hours and continue until the function of the muscle of joint return to normal
3. In case of severe bone contusion x-ray confirms the diagnosis. In the case physio therapy and massage should be applied.
4. Since sports activity may stimulate additional complications rest should be given
5. Heat is applied to the site in most cases.

### **(iii)Fractures**

#### **Check your progress**

Notes : a)Write your answer in the space given below

b)Compare your answer with the those given at the end of the unit

1.Describe the concept of Athletic injuries with proper first aids to them

### **3.10 Let us sum up**

The present unit tries to make you to understand the concept of health education with its objectives and importance. Also it provides how to render health education in schools. Further it introduces the basic concept of safety education.

### **3.11 Unit end activities**

1. State the importance of health education at the school level.

2. Discuss briefly about safety education.

**3.12 Answer to check your progress**

**1. a**

**2. d**

**3. d**

**4.** Refer the course material

**5.** Refer the course material

**3.13 Suggested Readings**

**8.** Dash. B.N (2007), Health and Physical Education, New Delhi, Neelkamal publications.

**9.** Svendra Chandra, Sothi, Puri Krishnan “Health Education and Physical Education”, Surject Publications Delhi, 2005.

**10.** Show, Dhanajoy and Kaushick Seema, “Lesson planning-Teaching Methods and class Management in Physical Education”, Khal Sahitya Kendra, New Delhi, 2007.

## **UNT IV**

### **CAUSES AND PREVENTION OF DISEASES**

#### **Structure**

**4.1 Introduction**

**4.2 Objectives**

**4.3 Life style disorders**

**4.4 Heart diseases**

**4.5 Cancer**

**4.6 HIV/AIDS**

**4.7 Reproductive helpless health**

**4.8 Osteoporosis & Depression**

**4.9 Intentional and unintentional injuries**

**4.10 Diabetes and obesity**

**4.11 Back pain: causes, symptoms and prevention-Addiction: Alcoholism, smoking and drugs.**

**4.12 Communicable diseases**

**4.13 Let us sum up**

**4.14 Unit end activities**

**4.15 Answers to check your progress**

**4.16 Suggested readings**

#### **4.1. Introduction**

The prime aim of life is to have healthy life. Due to modernization, the life style gets affected and paves ways for the unhealthy life styles. The main aim of this unit is to make you to understand the concept of causes and preventive measures to a few threatening diseases. Let us see the objectives first and move to the concept gradually

#### **4.2 Objectives**

After learning this unit, you will be able to:

- (i) Describe the life style disorders with reference to few diseases
- (ii) Know the concept of Diabetics and obesity and its impact on human health
- (iii) Understand the basic nature of communicable diseases –causes, symptoms and prevention in an understandable manner.

#### **4.3 Life style disorders:**

##### **Meaning:**

A particular lifestyle of person is a cumulative product of his/her physical capacity coordinate with psychological functioning, displayed in the form of habits, behavior, dietary and living pattern based on his own training sought from childhood, and mimics he gained from his immediate companions including parents, siblings, peers, etc. Thus, it involves a pure psychological and innate control over the physical and sensory activities. When this initiation, control, and co-ordination are disturbed, it leads to the derangement of lifestyle and results in any lifestyle disorder. Improper removal of the waste products formed during metabolism leading to accumulation of toxins is the basic cause of a disease. Therefore, the habit of suppression of urge in improper lifestyle can be considered as one of the root causes of lifestyle diseases. These preventable chronic diseases are the outcome of our unhealthy choices. Identifying the causes of lifestyle diseases is critical, because the elimination of the causes is the obvious and only way to achieve healing and enhanced health. Physical activity improves cardiovascular fitness, strength and flexibility, and burns up calories to keep fit and trim. This improves the individual's looking, feeling and thinking better.

**Causes:**

- Dehydration: Dehydration of the muscles and tendons is a primary cause of muscle fatigue, strain, tendonitis, and other disorders of the musculoskeletal system.
- Malnutrition: The lack of living foods in our diet along with the overconsumption of dead foods causes chronic diseases.
- Inflammation: Inflammation is a primary cause of most lifestyle related disorders, including heart disease and musculoskeletal disorders.
- Fatigue: Lack of sleep is associated with numerous, serious medical illnesses including: high blood pressure, heart disease, stroke, obesity, and mental impairment.
- Poor physical fitness: It's widely recognized that there's a direct correlation between poor levels of physical fitness and increased risk of chronic diseases.

**Prevention:**

- Regular health screening.
- Right choice of food
- Cutting down your sugar intake to avoid unnecessary calorie intake that could lead to weight gain.
- Using less salt in your meals; instead, spice up your food with herbs and spices.
- Limiting intake of high fat foods to maintain a healthy body weight and heart.
- Proper rest and relaxation.
- Avoid alcohol intake

**4.4 Heart diseases****Heart Diseases:**

**Cardiovascular disease (CVD)** is a class of diseases that involve the heart or blood vessels. Cardiovascular disease includes coronary artery diseases (CAD) such as Angina and Myocardial (commonly known as a heart attack). Other CVDs are stroke, hypertensive heart disease, rheumatic heart disease, cardiomyopathy, atrial fibrillation, congenital heart disease, endocarditic, aortic aneurysms, peripheral artery disease and venous thrombosis.

**Causes:**

There are several risk factors for heart diseases. They are age, gender, tobacco use, physical inactivity, excessive alcohol consumption, unhealthy diet, obesity, family history of cardiovascular disease, raised blood pressure (hypertension), raised blood sugar (diabetes mellitus), raised blood cholesterol, psychosocial factors, poverty and low educational status, and air pollution. While the individual contribution of each risk factor varies between different communities or ethnic groups the overall contribution of these risk factors is very consistent. Some of these risk factors, such as age, gender or family history, are immutable; however, many important cardiovascular risk factors are modifiable by lifestyle change, social change, drug treatment and prevention of hypertension, hyperlipidemia, and diabetes. Age is very much related to serum cholesterol level. The serum total cholesterol level increases as age increases. In men, this increase levels off around age 45 to 50 years. In women, the increase continues sharply until age 60 to 65 years. The risk of stroke doubles every decade after age 55. Men are at greater risk of heart disease than pre-menopausal women. Once past menopause, it has been argued that a woman's risk is similar to men. If a female has diabetes, she is more likely to develop heart disease than a male with diabetes. It is also found that gender differences explain nearly half the risk associated with cardiovascular diseases. One of the proposed explanations for gender differences in cardiovascular diseases is hormonal difference. Among women, estrogen is the predominant sex hormone. Estrogen may have protective effects through glucose metabolism and hemostatic system, and may have direct effect in improving endothelial cell function. The production of estrogen decreases after menopause and this may change the female lipid metabolism. Another main cause is physical inactivity. Insufficient physical activity is currently the leading risk factor for mortality worldwide. In addition, physical activity assists weight loss and improves blood glucose control, blood pressure, lipid profile and insulin sensitivity. These effects may, at least in part, explain its cardiovascular benefits. High dietary intakes of saturated fat, trans-fats and salt and low intake of fruits, vegetables and fish are linked to cardiovascular risk. The amount of dietary salt consumed is also an important determinant of blood pressure levels and overall cardiovascular risk. Frequent consumption of high-energy foods, such as processed foods that are high in fats and sugars, promotes obesity and may increase cardiovascular risk.

**Prevention:**

- Low-fat, high-fiber diet including whole grains and fruit and vegetables. Five portions a day reduce risk by about 25%.
- Tobacco cessation and avoidance of second-hand smoke
- Avoid alcohol consumption.
- Lower blood pressures, if elevated
- Decrease non-HDL cholesterol.
- Decrease body fat if overweight or obese
- Increase daily activity to 30 minutes of vigorous exercise per day at least five times per week
- Reduce sugar consumptions
- Decrease psychosocial stress.

**4.5.CANCER:****Meaning:**

Cancer is also known as a malignant tumor or malignant neoplasm, is a group of diseases involving abnormal cell growth with the potential to invade or spread to other parts of the body. Not all tumors are cancerous. Possible signs and symptoms include a new lump, abnormal bleeding, a prolonged cough, unexplained weight loss, and a change in bowel movements among others. While these symptoms may indicate cancer, they may also occur due to other issues. There are over 100 different known cancers that affect humans.

The characteristics of cancer cells are:

- Cell growth and division without the proper signals to do so
- Continuous growth and division even when there are signals telling them to stop
- Avoidance of programmed cell death
- Limitless number of cell divisions
- Promoting blood vessel construction
- Invasion of tissue and formation of metastases



**Causes:**

Most cancers are related to environmental, lifestyle, or behavioral exposures. The term "environmental", as used by cancer researchers, refers to everything outside the body that interacts with humans. In this sense, the environment is not limited to the biophysical environment (e.g. exposure to factors such as air pollution or sunlight, encountered outdoors or indoors, at home or in the workplace), but also includes lifestyle, economic and behavioral factors. Common environmental factors that contribute to cancer death include tobacco. It is nearly impossible to prove what caused a cancer in any individual, because most cancers have multiple possible causes. For example, if a person who uses tobacco heavily develops lung cancer, then it was probably caused by the tobacco use, but since everyone has a small chance of developing lung cancer as a result of air pollution or radiation, then there is a small chance that the cancer developed because of air pollution or radiation. Cancer is generally not contagious in humans, though it can be caused by oncoviruses and bacteria. It should be noted that aging has been repeatedly and consistently regarded as an important aspect to consider when evaluating the risk factors for the development of particular cancers; aging is considered a risk factor and this is explained by the observation that many molecular and cellular changes are involved in the development of cancer, so it is very likely that these changes accumulate during the aging process. Cancers are potentially avoidable by reducing key risk factors, of which much the significant is tobacco use, which is the cause for more cancer deaths. Another important reason is obesity, a poor diet, lack of physical activity, and drinking alcohol. Other factors are infections, exposure to ionizing radiation, and environmental pollutants. In the developing world nearly 20% of cancers are due to infections such as hepatitis B, hepatitis C, and human papilloma virus. These factors act, at least partly, by changing the genes of a cell. Typically many such genetic changes are required before cancer develops. Approximately 5–10% of cancers are due to genetic defects inherited from a person's parents.

**Types of Cancer**

There are more than 100 types of cancer. Types of cancer are usually named for the organs or tissues where the cancers form. For example, lung cancer starts in cells of the lung, and brain

cancer starts in cells of the brain. Cancers also may be described by the type of cell that formed them, such as an epithelial cell or a squamous cell.

- **Carcinoma:** Carcinomas are the most common type of cancer. They are formed by epithelial cells, which are the cells that cover the inside and outside surfaces of the body.
- **Sarcoma:** Sarcomas are cancers that form in bone and soft tissues, including muscle, fat, blood vessels, lymph vessels, and fibrous tissue.
- **Leukemia:** Cancers that begin in the blood-forming tissue of the bone marrow are called leukemia. These cancers do not form solid tumors. Instead, large numbers of abnormal white blood cells (leukemia cells and leukemic blast cells) build up in the blood and bone marrow, crowding out normal blood cells. The low level of normal blood cells can make it harder for the body to get oxygen to its tissues, control bleeding, or fight infections.
- **Lymphoma:** Lymphoma is cancer that begins in lymphocytes (T cells or B cells). These are disease-fighting white blood cells that are part of the immune system. In lymphoma, abnormal lymphocytes build up in lymph nodes and lymph vessels, as well as in other organs of the body.
- **Brain and Spinal Cord Tumors:** There are different types of brain and spinal cord tumors. These tumors are named based on the type of cell in which they formed and where the tumor first formed in the central nervous system. For example, an astrocytic tumor begins in star-shaped brain cells called astrocytes, which help keep nerve cells healthy. Brain tumors can be benign (not cancer) or malignant (cancer).

#### **Preventive measures:**

- Avoid tobacco
- Healthy diet- **Plenty of fruits and vegetables** and other foods from plant sources ,whole grains and beans.
- Avoid obesity- Eating lighter and leaner by choosing fewer high-calorie foods, including refined sugars and fat from animal sources.
- Limit processed meats- A report from the International Agency for Research on Cancer, the cancer agency of the World Health Organization, concluded that eating large amounts of processed meat can slightly increase the risk of certain types of cancer.

- Maintain a healthy weight and be physically active lower the risk of various types of cancer, including cancer of the breast, prostate, lung, colon and kidney.

#### **4.6 HIV/AIDS**

HIV/AIDS the Acquired Immuno-Deficiency Syndrome (some times called “slim disease”) is a newly described, usually fatal illness caused by a retrovirus of the **lent virus** group known as the **Human Immuno Deficiency Virus (HIV)** which breaks down the body’s immune system, leaving the victim vulnerable to subsequent development of persistent constitutional symptoms or diseases such as secondary infections, neoplasm and, neurological disorders. AIDS can be called our modern pandemic, affecting both industrialized and developing countries.

AIDS stands **Acquired Immuno Deficiency Syndrome.**

A-Means acquired from outside

I- Refers to body immune system (defense mechanism of the human body)

D- Indicates the weakening of the immune system

S- Refers to the presence of signs and symptoms

AIDS is a serious disorder of the immune system. AIDS was first recognized in USA in 1981. First confirmed evidence of AIDS infection in India came in April 1986. Sexual contact is the major mode of transmission of HIV worldwide.

The virus can be transmitted by infected blood or blood products, both in individuals who share contaminated needles and those who receive transfusions of blood or blood products. Infected mother transmit the virus to the infants. The incubation period for adults is approximately 8-10 years, whereas children under 5 years of age generally develop symptoms within 2 years.

#### **Signs and Symptoms**

1. Majority experience no recognizable signs or symptoms, but some develop acute illness showing-fevers, rigors, arthragis, abdominal cramps, diarrhoea, aseptic meningitis etc.
2. Fever persisting for more than one month.
3. Weight loss of greater than 10% of baseline.
4. Diarrhea persisting for more than one month.
5. Persistent cough for a period longer than one month.
6. General itching dermatitis.

7. Recurrent Herpes Zoster
8. Oropharyngeal candidiasis-fungal infection in mouth and throat.
9. Swelling in lymph glands-Lymphadenopathy

### **Prevention and Treatment**

1. Prevention of sexual transmission is an immediate priority education, counseling and behavior modification in sexual contacts and –safe sex assume importance.
2. Screening of blood and blood products for HIV antibodies by through testing of blood samples sometimes blood screening will be a failure during window period of an infected HIV patient and universal precautions while handling blood and body fluids.
3. Prevent blood borne transmission of HIV by using disposable syringe, properly boiled needles. Avoid sharing of injection, equipments and follow reduction in drug usage.
4. To avoid transplacental or prenatal transmission of HIV, HIV infected women should avoid pregnancy
5. Counseling and contraceptive service should be made available to HIV infected persons.

### **Check your progress**

Notes : a)Write your answer in the space given below

b)Compare your answer with the those given at the end of the unit

1. Commonly the ‘Slim disease’ refers the

a) Cancer b)HIV/AIDS c)Heart disease d )None of the above

( )

2.Is heart disease a mild or dangerous-Justify

3.Discuss about the issues of HIV/AIDS

### **4.7 Reproductive helpless health**

Reproductive health is defined as” A state of complete physical, mental, and social well being and not merely the absence of disease or infirmity, in all matters related to the reproductive system and to its functions and process”. Reproductive health is defined as a state of physical,

mental, and social well-being in all matters relating to the reproductive system, at all stages of life. Good reproductive health implies that people are able to have a satisfying and safe sex life, the capability to reproduce and the freedom to decide if, when, and how often to do so. Men and women should be informed about and have access to safe, effective, affordable, and acceptable methods of family planning of their choice, and the right to appropriate health-care services that enable women to safely go through pregnancy and childbirth.

#### **4.8. Osteoporosis & Depression**

##### **Causes:**

Loss of bone mass is the leading cause of osteoporosis and bone fractures among the aged in general and among post-menopausal women in particular. People with major depression generally have a lower bone mass density. Depression may increase the risk of the bone disorder osteoporosis in premenopausal women. Depressed women have overactive immune systems that make too many inflammatory chemicals, one of which actually promotes bone loss. Depression is a common chronic condition and that thinning of bones (osteopenia) is often “clinically silent” (without signs or symptoms). Osteoporosis is a chronic illness with potentially life-altering consequences when not managed properly. Osteoporosis is a disease characterized by low bone mass and the deterioration of bone tissue. The bones weaken, putting those affected at greater risk of suffering a broken bone or fragility fracture. Fragility fractures are those that occur following a minor trauma, such as a fall from standing height, a sitting position or having missed 1-3 steps in a staircase.

##### **Signs of depression:**

- Depressed mood.
- Marked loss of interest or pleasure in activities which used to give you pleasure
- Significant weight loss or gain.
- Insomnia or difficulty sleeping (usually waking up in the early morning rather than having difficulty falling asleep) or sleeping too much.
- Lack of interest or concern about what's going on around you.
- Feelings of agitation.

- Lack of energy.
- Feelings of worthlessness and/or guilt.
- Inability to concentrate or make decisions.

**Prevention:**

- Built a strong social support network
- Cultivate the habit of meditation
- Have a deep sleep for 6 to 8 hours.
- Make yourself physically fit
- Nurture your body, mind and spirit in a positive and enjoyable way.

**4.9. Intentional and unintentional injuries**

**Unintentional injuries** are harmful acts that occurred without any intention of causing damage to oneself or others. A large proportion of unintentional injuries occur in or around the home and many of these injuries occur as a result of falls, like down the stairs or when someone uses a ladder to fix something. Motor vehicle crashes, unintentional poisonings, suffocation, drowning, accidental firearm discharges, and burns. For people aged 65 or older, unintentional falls are the number one cause of unintentional injury death. Those in the age group of 25-64 should be wary of unintentional poisonings with substances at home like chemicals, drugs, and so on. Children and young adults aged 5-24 who die as a result of an unintentional injury mainly do so because of problems sustained from motor vehicle related accidents. And children below the age of five are most at risk for unintentional death via suffocation and drowning, hence the need to watch the kiddies near the tub and pool.

**Intentional Injuries:** In contrast to unintentional injuries are intentional injuries, which are injuries resulting from purposeful harmful actions upon oneself or others. Violence is a term that describes the exercise of force to harm oneself or another person. It's similarly a very unfortunate fact that the majority of these intentional injury deaths occur not by the hands of others, but when a person commits suicide. The three major contributing factors to suicide deaths are firearms, suffocation, and poisoning. Injuries are responsible for countless lost lives, decreased quality of

life, and substantial health care costs. While injuries afflict everyone, people of color and low-income populations are particularly vulnerable.

**Prevention:**

1. Begin a regular exercise program to increase the balance, strength, and flexibility.
2. Consult with a health professional about getting a fall risk assessment.
3. Have all medications, prescription and over-the-counter, reviewed periodically for drug interactions that could lead to falls.
4. Get your vision checked at least annually by an eye doctor.
5. Make your home safer by reducing tripping hazards, installing handrails and grab bars and improving lighting.

**4.10. Diabetes and obesity**

**What is Diabetics?**

Diabetes is a complex group of diseases with a variety of causes. People with diabetes have high blood glucose, also called high blood sugar or hyperglycemia. Diabetes is a disorder of metabolism- the way the body uses digested food for energy. The digestive tract breaks down carbohydrates, sugars and starches found in many foods into glucose, a form of sugar that enters the bloodstream. With the help of the hormone insulin, cells throughout the body absorb glucose and use it for energy. Diabetes develops when the body doesn't make enough insulin or is not able to use insulin effectively, or both. Insulin is made in the pancreas, an organ located behind the stomach. The pancreas contains clusters of cells called islets. Beta cells within the islets make insulin and release it into the blood. If beta cells don't produce enough insulin, or the body doesn't respond to the insulin that is present, glucose builds up in the blood instead of being absorbed by cells in the body, leading to prediabetes or diabetes. Over time, high blood glucose damages nerves and blood vessels, leading to complications such as heart disease, stroke, kidney disease, blindness, dental disease, and amputations. Other complications of diabetes may include increased susceptibility to other diseases, loss of mobility with aging, depression, and pregnancy problems. No one is certain about the causes for diabetes, but scientists believe genes and environmental factors interact to cause diabetes in most cases. The two main types of diabetes are type 1 diabetes and type 2 diabetes. A third type, gestational diabetes, develops only during pregnancy. Other types of diabetes are caused by defects in specific genes, diseases of the

pancreas, certain drugs or chemicals, infections, and other conditions. Some people show signs of both type 1 and type 2 diabetes.

**Causes:** Diabetes is caused by a lack of insulin due to the destruction of insulin producing beta cells in the pancreas. In type 1 diabetes the body's immune system attacks and destroys the beta cells. Normally, the immune system protects the body from infection by identifying and destroying bacteria, viruses, and other potentially harmful foreign substances. The immune system attacks the body's own cells. In type 1 diabetes, beta cell destruction may take place over several years, but symptoms of the disease usually develop over a short period of time. Type 1 diabetes typically occurs in children and young adults, though it can appear at any age. In the past, type 1 diabetes was called juvenile diabetes or insulin-dependent diabetes mellitus. Latent autoimmune diabetes in adults (LADA) may be a slowly developing kind of type 1 diabetes. Diagnosis usually occurs after age 30. In LADA, as in type 1 diabetes, the body's immune system destroys the beta cells. At the time of diagnosis, people with LADA may still produce their own insulin, but eventually most will need insulin shots or an insulin pump to control blood glucose levels.

### **Obesity and Physical Inactivity**

Physical inactivity and obesity are strongly associated with the development of type 2 diabetes. People who are genetically susceptible to type 2 diabetes are more vulnerable when these risk factors are present. An imbalance between caloric intake and physical activity can lead to obesity, which causes insulin resistance and is common in people with type 2 diabetes. Central obesity, in which a person has excess abdominal fat, is a major risk factor not only for insulin resistance and type 2 diabetes but also for heart and blood vessel disease, also called cardiovascular disease (CVD). This excess "belly fat" produces hormones and other substances that can cause harmful, chronic effects in the body such as damage to blood vessels.

### **Prevention:**

- Get more physical activity
- Get plenty of fiber
- Choose whole grains and whole grain products over highly processed carbohydrates.



- Skip the sugary drinks, and choose water, coffee, or tea instead.
- Choose good fats instead of bad fats.
- Limit red meat and avoid processed meat; choose nuts, whole grains, poultry, or fish instead.
- Avoid smoking
- Avoid alcohol content

#### **4.11. Back pain: causes, symptoms and prevention**

**Meaning:** Pain felt in the low or upper back. Causes of pain in the low and upper back include conditions affecting the bony spine, discs between the vertebrae, ligaments around the spine and discs, spinal inflammation, spinal cord and nerves, muscles, internal organs of the pelvis, chest, and abdomen, tumors, and the skin. The back is a complex structure made up of 33 vertebrae, over 30 muscles, numerous ligaments, multiple joints, and inter-vertebral discs.

##### **Types and its Causes:**

- 1) **Muscular Strains:** The most common cause of back pain is due to muscular strains. This happens when an unexpected force, twist, or pull is applied to one or several of the muscles in the back. As a result, several tears occur in the muscle. These muscular tears cause pain felt in the back.
- 2) **Ligamentous sprains:** This occurs when the ligaments of the back are stretched beyond their means.
- 3) **Spinal stenosis:** It occurs more commonly in people over 50 years old. The term refers to a narrowing of the spinal canal. Spinal stenosis has many causes including thickened ligaments along the spinal canal, bony spurs, and enlarged joint cartilage from arthritic changes.
- 4) **Osteoporosis:** This occurs especially in women. It is a disease characterized by progressive loss of bone density. This results in thinning of bone tissue making one more susceptible to fractures, or broken bones. The bones of the spine are especially affected in this disorder. Injury from falls, lifting of heavy objects, or even the force of sneezing can result in painful vertebral compression fractures.

5) **Fibromyalgia:** It is a rheumatic condition characterized by widespread soft tissue pain, fatigue, sleep disturbance, and the presence of evenly distributed areas of tenderness. A history of at least three months of widespread pain and tenderness in eleven or more of the eighteen designated tender point sites is required in diagnosing this disorder.

**Symptoms:**

- The large nerve roots in the low back that go to the legs may be irritated
- The smaller nerves that supply the low back may be irritated
- The large paired lower back muscles (erector spinae) may be strained
- The bones, ligaments or joints may be damaged
- An intervertebral disc may be degenerating

**Prevention:**

- 1) Bend your knees and keep your back straight. Don't bend at your waist.
- 2) Keep the object close to you. The farther away you hold it from your body, the more it stresses your back.
- 3) Never hold an item higher than your armpit or lower than your knees.
- 4) Don't move something that weighs more than 20% of your body weight.
- 5) Don't pivot, twist, or turn while lifting. Point your feet at the item you're lifting and face it as you pick it up. Change direction with your feet, not your waist.

**4.11.1Addiction: Alcoholism, smoking and drugs**

**Addition meaning:** The state of being enslaved to a habit or practice or to something that is psychologically or physically habit-forming, as narcotics, to such an extent that its cessation causes severe trauma. Compulsive physiological need for and use of a habit-forming substance (as heroin, nicotine, or alcohol) characterized by tolerance and by well-defined physiological symptoms upon withdrawal .it is *broadly explained as* persistent compulsive use of a substance known by the user to be physically, psychologically, or socially harmful.

**Smoking:** The relationship between smoking and longevity is so strong that, especially for men in their sixties, smoking is the single most accurate predictor of remaining life expectancy. On the average, cigarette smokers die ten years sooner than otherwise comparable non-smokers. In addition to causing lung cancer, heart disease, emphysema, and hypertension, cigarette smoking is also a major risk factor for cerebrovascular disease, causing strokes and reducing mental functioning. It can be said that all smokers, regardless of age, have a 70% greater probability of experiencing coronary. Although the damage from smoking cigarettes can never be reversed, stopping lessens the heart disease probability of heart disease. The body's first reaction to smoking may include sweating, nausea, and even vomiting; but a tolerance to the effects of nicotine is soon developed, and nicotine is strongly physically addictive. Unfortunately, the detrimental effects of nicotine remain a danger. Smoking should be eliminated to avoid or control hypertension. Hypertension can cause damage to all of the body organs, but especially the brain, heart, and kidneys. Most lung cancers are caused by smoking, and the prognosis for lung cancer is poor. The major cause of the increase in cancer deaths has been the increase of lung cancer. Both chronic bronchitis and emphysema (collectively known as chronic obstructive lung disease) are usually due to smoking. No therapy can reverse the lung destruction of emphysema. Emphysema produces holes in the lung. People with emphysema may be constantly struggling to breathe.

**Drinking:** Alcohol is the most widely used intoxicant known to humans. Alcohol use is also very often associated with physical illness, mental illness, family conflicts, other social problems, poverty, and crime. Alcohol is a major factor in the causation of cirrhosis of the liver, which is responsible for over half of all deaths between the ages of 45 and 65. Also, alcohol has been shown to injure the brain and heart. Alcohol is carried by the bloodstream to the central nervous system (the brain and spinal cord), and has both physical and psychological effects. It is an anesthetic, a tranquilizer, and a depressant. Because as a tranquilizer it reduces inhibitions - especially in social settings where its effects include increased conversation and activity. The way alcohol induces mood changes though, is to depress the part of the brain involved in sending out instructions to the body. The resulting impairment of motor coordination is the most measurable of the effects of alcohol.

**Drug abuse:** It is the habitual use of drugs to alter one's mood, emotion, or state of consciousness. This includes the destructive pattern of using substance or chemicals that leads to significant physical, mental, emotional problems or distress. Drug comes in many forms. People who consume drugs, chemicals or substances by swallowing, injecting, applying to skin, or any other way to enhance their looks, mood, performance, or influence their thinking is committing an act of drug abuse, because inevitably, it will have some very bad results sooner or later.

**Prevention:**

- Educate yourself about drugs
- Set an example
- Set clear boundaries
- Always keep lines of communication open

#### **I4.11.2 Impact of pollution on human health**

**Meaning:** Pollution is the introduction of contaminants into the natural environment that causes adverse change. Pollution can take the form of chemical substances or energy, such as noise, heat or light. Pollutants, the components of pollution, can be either foreign substances/energies or naturally occurring contaminants. Pollution is often classed as point source or nonpoint source pollution. The point sources are easy to identify, monitor and control, whereas the non-point sources are hard to control. The contamination of air, water, or soil by substances those are harmful to living things. Light from cities and towns at night that interferes with astronomical observations is known as light pollution. It can also disturb natural rhythms of growth in plants and other organisms. Continuous noise that is loud enough to be annoying or physically harmful is known as noise pollution. Heat from hot water that is discharged from a factory into a river or lake, where it can kill or endanger aquatic life, is known as thermal pollution.

#### **Types & Causes of Pollution**

**Air Pollution :** Air pollution is the most prominent and dangerous form of pollution. It occurs due to many reasons. Excessive burning of fuel which is a necessity of our daily lives for cooking, driving and other industrial activities, releases a huge amount of chemical substances in the air every day, these pollute the air. Smoke from chimneys, factories, vehicles or burning of

acid rain basically occurs due to coal burning, this releases sulphur dioxide into the air making it toxic. The effects of air pollution are evident too. Release of sulphur dioxide and hazardous gases into the air causes global warming and acid rain which in turn have increased temperatures, erratic rains and droughts worldwide making it tough for the animals to survive. Breathing this polluted particle from the air result is increase in asthma and cancer in the lungs.

**Water Pollution:** Water Pollution has taken toll of all the surviving species of the earth. Almost 60% of the species live in water bodies. It occurs due to several factors the industrial wastes dumped into the rivers and other water bodies cause an imbalance in the water leading to its severe contamination and death of aquatic species. If you suspect that nearby water sources have been contaminated by a corporation then it might be a good idea to hire an expert to see your options. Also spraying insecticides, pesticides like DDT on plants pollutes the ground water system and oil spills in the oceans have caused irreparable damage to the water bodies. Eutrophication is another big source for water pollution. It occurs due to daily activities like washing clothes, utensils near lakes, ponds or rivers. This forces detergents to go into water which blocks sunlight from penetrating, thus reducing oxygen and making it inhabitable. Water pollution not only harms the aquatic beings but it also contaminates the entire food chain by severely affecting humans dependent on these. Water-borne diseases like cholera, diarrhea has also increased in all places.

**Soil pollution:** Soil Pollution occurs due to incorporation of unwanted chemicals in the soil due to human activities. Use of insecticides and pesticides absorbs the nitrogen compounds from the soil making it unfit for plants to derive nutrition from. Release of industrial waste, mining and deforestation also exploits the soil. Since plants can't grow properly, they can't hold the soil and this leads to soil erosion.

**Noise Pollution:** **Noise pollution** is caused when noise which is an unpleasant sound affects our ears and leads to psychological problems like stress, hypertension, hearing impairment, etc. It is caused by machines in industries, loud music, etc.

**Radioactive pollution:** Radioactive pollution is highly dangerous when it occurs. It can occur due to nuclear plant malfunctions, improper nuclear waste disposal, accidents, etc. It causes cancer, infertility, blindness, and defects at the time of birth; can sterilize soil and affect air and water.

**Thermal/heat pollution:** Thermal pollution is due to the excess heat in the environment creating unwanted changes over long time period. Due to huge number of industrial plants, deforestation and air pollution. It increases the earth's temperature, causing drastic climatic changes and extinction of wildlife.

**Light pollution:** Light pollution occurs due to prominent excess illumination of an area. It is largely visible in big cities, on advertising boards and billboards, in sports or entertainment events at the night. In residential areas the lives of the inhabitants is greatly affected by this. It also affects the astronomical observations and activities by making the stars almost invisible.

#### **Effects on human health:**

1. **Environment Degradation:** Environment is the first casualty for increase in pollution weather in air or water. The increase in the amount of CO<sub>2</sub> in the atmosphere leads to smog which can restrict sunlight from reaching the earth. This prevents plants from the process of photosynthesis. Gases like Sulfur dioxide and nitrogen oxide can cause acid rain. Water pollution in terms of Oil spill may lead to death of several wildlife species.

2. **Human Health:** The decrease in quality of air leads to several respiratory problems including asthma or lung cancer. Chest pain, congestion, throat inflammation, cardiovascular disease, respiratory disease is some of diseases that can be causes by air pollution. Water pollution occurs due to contamination of water and may pose skin related problems including skin irritations and rashes. Similarly, Noise pollution leads to hearing loss, stress and sleep disturbance.

3. **Global Warming:** The emission of greenhouse gases particularly CO<sub>2</sub> is leading to global warming. Every other day new industries are being set up, new vehicles come on roads and trees are cut to make way for new homes. The increase in CO<sub>2</sub> leads to melting of polar ice caps which increases the sea level and pose danger for the people living near coastal areas.

**4. Ozone Layer Depletion:** Ozone layer is the thin shield high up in the sky that stops ultra violet rays from reaching the earth. As a result of human activities, chemicals, such as chlorofluorocarbons (CFCs), were released into the atmosphere which contributed to the depletion of ozone layer.

**5. Infertile Land:** Due to constant use of insecticides and pesticides, the soil may become infertile. Plants may not be able to grow properly. Various forms of chemicals produced from industrial waste are released into the flowing water which also affects the quality of soil.

**Preventive measures:**

**Prevention of air pollution:**

- (i) Using smokeless sources of energy like smokeless stoves, which use biogas, solar energy, etc.
- (ii) Using devices for filtering smoke in chimneys of factories and powerhouses.
- (iii) Planting more trees.
- (iv) Locating industries away from residential areas.
- (v) Strictly checking pollution levels in automobiles' exhaust emission.

**Prevention of water pollution:**

- (i) Adequate sewage and industrial waste treatment in sewage treatment plants before dumping them into river bodies.
- (ii) Recycling-various products should be recycled instead of dumping them into rivers, e.g., biogas can be made from city waste.

**Prevention of land pollution:**

- (i) Proper solid waste disposal like sanitary landfill.
- (ii) Using limited amounts of fertilizers and pesticides.
- (iii) Avoiding polythene bags.

## 4.12 COMMUNICABLE DISEASE

In ancient time, people were not sufficiently aware of diseases. Hippocrates the father of medicine was the first physician of Greece, who described the symptoms of diseases in detail. After a long gap, Robert Koch a German scientist, studied the various causes of diseases and concluded that diseases spread through germs. Since then medical scientists are engaged in research work but we are still often attacked by new diseases.

The environment in which we live has a vital influence on us in spite of many scientific achievements. We live in a highly competitive world where struggle for survival is acute. Our internal environment is persistently under the influence of external forces of nature.

Diseases that can be passed or transmitted from one person to another are called-infectious or contagious disease.

**Infectious disease**-is a “disease of man resulting from an infection”.

**Contagious disease:** is “one that is transmitted through direct contact”.

A disease of infectious nature can be transmitted from one person to another or from a reservoir to a susceptible host, directly (or) indirectly is called as a **communicable disease**.

### **Incubation period**

The time period required for the transmission of infectious agent from a reservoir to a susceptible host is to, because the disease is known as communicable period or incubation period.

The infectious agents may be virus, bacteria, protozoa, fungi, rickets etc. this disease may be directly or indirectly transmitted from man to man, animal to animal, from the environment like through air, dust, soil water, food, insects etc to man and to animal.

1. Air borne Diseases-Tuberculosis, whooping cough, small pox.
2. Water & food borne diseases-Typhoid, Cholera, Dysentery, diarrhea.
3. Through Direct contact-sexual disease AIDS.
4. Through insects- Malaria.

### **A. AIR BORNE DISEASES**

#### **1. Whooping Cough**

Whooping cough (Pertusis) is highly infectious disease of young children which causes inflammation of the respiratory tract with severe attacks of cough. It is airborne in nature.



## Symptoms

1. Onset is sudden cold and in the beginning simple mild cough with fever.
2. Severe running of nose and sneezing
3. Later severe bouts of coughing and that will become more severe at late night ending in deep inspiration during which the characteristic whoop occurs.
4. Face turns red and eyes bulges with tears and ends with vomiting.
5. Lungs severely affected.

## Treatment and Prevention

1. Keep the child in a warm and ventilated room?
2. Keep the infected child in a separate room
3. Discharges from nose and throat should be disposed immediately and disinfection should be done.
4. Give light food to the infected.
5. In early stage itself the child need to be immunized against whooping cough with DPT vaccine at 2<sup>nd</sup>, 3<sup>rd</sup>, 4<sup>th</sup> months, 1<sup>1/2</sup> and 5 years.
6. As a treatment, erythromycin may be injected in consultation with a physician to reduce the severity of the infection

## 2. Small-Pox

It is known as a serious infectious disease. Even the grown up people also come under the grip of this infection. This infection is caused by **Typical Viruses**. However, the spread of infection is also caused by droplets and scabs floating in the air.

## Symptoms

- ❖ There is chill and headache in the beginning
- ❖ Severe pain in the back and limbs of the body
- ❖ Sometimes face becomes red.
- ❖ After three or four days eruptions appear on the forehead. Then they spread throughout the body and become watery blisters, diminishing, eruption becomes dry and at last crust starts falling.
- ❖ Itching feeling is also there is a eruption.
- ❖ Fever remains high for eight to nine days.

### **Precautions and Treatment**

- ❖ A child suffering from this disease should be segregated from others.
- ❖ Child should be got vaccinated against small pox
- ❖ Patient should be kept in a clean place.
- ❖ No medicine should be given except proper nursing.
- ❖ Patient should not be given salt.

### **Treatment**

- ❖ The stomach should be clean. Use soap water enemas as a purgative
- ❖ When temperature goes above 103<sup>0</sup> F, place cold compress or ice bad over the head.
- ❖ Give light easily digestible food
- ❖ Use boric lotion for reducing pain in the eyes.
- ❖ Used greasy substance for removing scabs.

## **B. WATER & FOOD BRONE DISEASES**

### **A. TYPHOID**

Typhoid is an acute infectious disease that affects the gastrointestinal tract. In countries where sanitation is poor and sub-standard, typhoid and paratyphoid may occur. The term enteric fever includes both typhoid and paratyphoid.

It caused by **Salmonella typhii**. Incubation period is 10-15 days. It spreads through faecal-oral route. Contamination of drinking water by way of sewage and food by way of flies are the main reasons for the spread of this disease. It affects almost all age category.

### **Signs and Symptoms**

1. Onset of sudden fever of moderate to high degree with rigors and chills.
2. Fever rises in step ladder fashion.
3. Malaise with headache and pain in the limbs
4. Tongue will be centrally coated
5. Low pulse
6. Diarrhea occurs
7. Constipation and retention of urine will occur because the germs attack intestine and cause ulcers.

8. Small rose coloured spots will be seen in the middle part of the body and these spots fade away later.
9. If the patient has a relapse of typhoid, the same symptoms reappear.

### **Prevention and Treatment**

1. Early detection and notification, to health authority
2. Active immunization by vaccines and inject other children with anti-typhoid injections.
3. Isolation of the infected
4. Proper disinfection of urine and stools is necessary and even burning after disinfection all excreta will be the right choice.
5. Boiled water and ensures safe water for drinking and administer light liquid food.
6. If fever rises beyond 103<sup>0</sup> F, apply cold compression to the head.
7. Complete bed rest is recommended for the infected persons.
8. Specific drugs on consultation with physician such as ciprofloxacin, chloromycetin should be administered.

### **B. CHOLERA**

It is an acute gastro-intestinal infection. It is epidemic as well endemic disease. The disease is caused by a germ called 'Vibrio cholera'. It spreads through contaminated drinking water, by flies, insects and improper storage. It also spreads from infected patients to others. It affects all age group. Incubation period is generally ranging from few hours to 5 days.

### **Signs and Symptoms**

1. It starts with diarrhea and the watery stools and vomiting leading to dehydration
2. Pain in the muscles of hands and feet is observed and it causes muscle cramps.
3. Too much thirst is felt
4. Urine output is suppressed
5. Fluid and electrolyte imbalance may occur
6. Fatal death occurs, if left uncared.

### **Prevention and Treatment**

1. Strict personal hygiene.
2. Boil water and safe water for drinking.
3. Early detection may be made by testing stools and immediately it should be reported to health authority.

4. Disinfection of clothing is recommended.
5. Disinfect surroundings with DDT and make it flies free.
6. Cholera vaccination
7. Adequate compensation of electrolytes and water by intravenous fluids and CRS solutions should be undertaken.
8. Provide antibiotics such as **Tetracycline**, and **Fuazolidone** in consultation with physician.

### **C. DIARRHOEA**

People suffer from this disease mostly in summer and rainy season. It is spread by flies. If it is allowed to continue it may take the shape of dysentery.

#### **Causes:**

- ❖ It is caused due to the spread of bacteria by flies.
- ❖ It is caused by the presence of bacteria in unripe food.
- ❖ It may be caused due to taking of infected food, water and other drinks.

#### **Symptoms**

There is frequent movement of bowels

#### **Remedies**

- Food should be protected from flies.
- Water should be disinfected before it is used.
- A person suffering from disease should take only very light food. During rainy or summer season.
- During rainy or summer season light diet should be taken.

## **C. THROUGH INSECT VECTORS**

### **A. MALARIA**

Malaria is a common disease found in most of the tropical regions of the world. It is a protozoan disease transmitted by the bite of anopheles mosquitoes. It is the most important parasitic disease of the human beings. Mode of transmission is by two means.

1. Mosquito transmission (Asexual) - An infected female anopheles mosquito may infect several persons. The mosquito is not infective unless the sporozoites are present in its salivary.

2. Human transmission (Asexual) – may be transmitted directly by injections of infected blood or plasma.-Eg. Blood transfusion, drug addicts using same syringe.

### **Symptoms**

There are three stages in the infection process:

1. **Cold stage-** A sudden onset of fever with rigors and chills and sensation of extreme cold & shivering which lasts about 15 minutes to one hour.
2. **Hot stage-** Temperature rises up to 100<sup>0</sup> F with intense head ache and the patient feels burning hot and casts of his clothes. This stage lasts for 2-6 hours.
3. **Sweating stage-** Fever decreases with profuse sweating. This is stage lasts for 2-4 hours.
4. In some cases, nausea, vomiting and delirium are common.
5. Mild anemia and a palpable spleen are also observed.

### **Prevention and Treatment**

1. Protection against mosquito by using repellants, protective clothing, bed nets and screening.
2. Control of adult infected mosquito/larvae-intermittent drying water containers and using larvicides to kill the mosquito larva sides. Spraying of insecticides will control also the mosquito.
3. To control human reservoir, mass drug administration should be undertaken in highly endemic areas.
4. Management of environmental sanitation, water and drainage will reduce the source of infection.

### **Keep the patient warm during the shivering stage**

1. Rub him down with a towel, sponge with weak vinegar and change his clothes when he has perspired.
2. Even after perspiration, if he temperature stays high, sponge the patient with cold water or apply cold packs.
3. If he feels headache, keep a cold wet cloth on the forehead.
4. Give enough water to drink.
5. Give a very light diet and during the attacks only provide liquids dirts.
6. Treat with quinine or other drug on doctor's advice.

### **Precautions to be taken School**

1. Malaria spreads during the spring and autumn hence see that no water collects in the school premises, or gardens, or about the compounds, which are breeding places for mosquitoes.
2. Destroy the mosquito by sprinkling kerosene on stagnant drains.
3. Advise parents not to have cesspits or cesspools near their houses.
4. Sprinkle DDT, or BHC to control mosquitoes which may breed in the walls and the corners.

### **Check your progress**

Notes : a) Write your answer in the space given below

b) Compare your answer with the those given at the end of the unit

1. How do you conceive the term ‘Diabetics’?
2. Suggest a few measures to handle the disease ‘Obesity’

### **4.14 Let us sum up**

This unit tries to through light on life style disorders with special reference to heart diseases, cancer, HIV/AIDS and so on. It also discusses n the communicable diseases such as malaria, swine flu typhoid cholera small pox etc., in a meaningful manner.

### **4.15 Unit end activities**

1. How would you control over the communicable diseases?
2. Write a note on the causes, symptoms and prevention of Tuberculosis.

### **4.16 Answers to check your progress**

**1. b**

**2. Refer this course material**

**3. Refer this course material**

**4. Refer this course material**

**5. Refer this course material**

**4.17 Suggested readings**

1. Bookwalter, Karl. W, "Physical Education in secondary Schools". The centre for applied.
2. Thomas.J.P, "Organization of Physical Education", Gnanodaya Press, Madras, 1972.
3. Bucher Charles. A. "Foundations of Physical Education", 8<sup>th</sup> Rd., the C.V. Mosby Co., St. Louis, 1979.

**UNIT V**  
**FIRST AID –PRINCIPLES AND USES**

**Structure**

**5.1 Introduction**

**5.2 Objectives**

**5.3 The aims and scope of first aid**

**5.4 Qualities of the first aider**

**5.5 Principles of first aid**

**5.6 First aid equipments**

**5.7 Fracture-causes and remedy**

**5.8 First aid related to..**

**5.9 Let us sum up**

**5.10 Unit end activities**

**5.11 Answer to check your progress**

**5.12 Suggested Readings**



## **5.1 Introduction**

First aid is the immediate treatment given to the victim of the accident or sudden illness before medical help is obtained. In this unit we are going to learn about the concept of first aid and its principles in life related situations.

## **5.2. Objectives**

After learning this unit, you will be able to:

- Describe the meaning and objectives of the first aid
- State the principles of first aid
- Know the various ways and means of using first aid
- Understand the concept of first aid equipments and first aid related to various diseases

## **5.3 The aims and scope of first aid**

First aid has three main aims

1. To preserve life
2. To promote recovery and
3. To prevent worsening of the causality's conditions until the victim receives the services of a doctor or arrangement transportation to hospital

First aid is based on scientific medicine and surgery it is skilled assistance But the first need not be a doctor. After the doctor takes charge the first aiders responsibility ends. He can then stand by to help the doctor.

The first aider should observe carefully think clearly and acts quickly. He should be calm cool and confident. He should not get excited. He should ask someone to call a doctor/inform hospital immediately by giving details about victim. While waiting for the doctor he should give first aid methodically.

## **The scope of first aid**

1. The First aider should examine the causality to know the details of injuries and their nature. This is known as diagnosis
2. The diagnosis will give him an idea of the treatment to be given until the doctor takes charge
3. The next step is to send the causality to his house or to be hospital as the case may be in a suitable atmosphere.

## **Diagnosis**

Diagnosis of a case based on its history signals and symptoms.

- a) History of the case is the study of the accident namely how the accident actually occurred. The causality will give history. If he is unconscious someone who saw the accident will help. The surroundings will add to the information like an abandoned scooter or a broken pillar near the place and its condition.
  - Symptoms are what the causality tells the first aider like pain shivering fairness etc. pain described by the causality will lead the first aider to the region of injury without waste of time.
  - Signs are what the first aider feels and finds out for himself like paleness swelling of parts injured bleeding deformity of the limbs etc. The training the first aider has undergone will help him make these observations correctly.

## **Treatment**

- It is in treating the causality that the first aiders training will come into use. The first aider should read his book again and again otherwise he may forget the principles of treatment. The main ideas are
- If the cause of the accident is still there remove it e.g. A live electric wire pillars or logs on body etc or remove the causality from the danger e.g. a burning house a room with poisonous gases etc.

- The following conditions require the first aiders prompt attention to failure of breathing stoppage of heart severe bleeding and shock poisoning major burns, head injuries and fractures.
- Continue the treatment until the doctor takes charge

### **Disposal**

The earlier the doctor takes charge the greater the chances of recovery. First take the casualty to the nearest shelter. The best of course is to the hospital or else it can be his house or the nearest clinic. The quickest means of transport should be made use of. A carefully worded message to the relatives as to his condition and also to what place he is being taken must be sent someone in the crowd will generally help in this It is of course the duty of police and they are most reliable.

### **5.4 Qualities of the first aider**

The following are the qualities that a trained first aider should possess

- Prompt and quick.
- As soon as an accident or injury takes place the first aider should be prompt and quick to render help to victim without delay.
- Calm and controlled.
- He should be a calm and controlled sort of man because he has to take immediate action without any fuss or panic.
- Wise and intelligent.
- He should be intelligent and wise enough to decide what immediate treatment is essential even before a complete diagnosis especially in case of serious injuries and severe bleeding.
- Resourceful.

- He should be resourceful enough to make available his first aid material at once or get the required things on the spot for giving immediate relief to the victim.

### **Sweet tempered and sympathetic**

The first Aider should use sweet and encouraging words to lessen the victim's distress. He should keep the victim as comfortable as possible. With sympathy he should be able to calm the victim's fears.

### **Skillful and tactful**

He should be skillful and tactful to know the symptoms and history of the case without any wasting the time. He must also be skillful to secure the confidence of the injured. If there is any crowd around the victim he should be tactful to control it. If needed he should get the assistance of one or more by standard to the best advantage of the injured.

### **Dexterous and Clever**

He should be clever enough to handle the patient without giving unnecessary pain and use the applications efficiency.

### **Faith and presurance**

He should have full faith in himself and in the success of its efforts. He should continue his efforts even if he was to handle all serious and non serious situations until proper medical aid is received.

## **5.5 Principles of First aid**

The following are the importance principles of first aid.

1. Remove the cause of injury or the patient from the cause as early as possible. He should then render such help that may prevent further injury.
2. The bleeding should be stopped immediately irrespective of other injuries.
3. Keep the patient warm by wrapping him in clothes rugs or blankets and sheets as the cause may be.

4. Remove the clothes of the patient only when essential such removal of clothes must not cause pain or discomfort to the patient. He should very softly study the ankle and then undo the laces of shoes and cut off the socks if needed.
5. The wound should be covered at once with a clean dressing In case of a fracture the injured limb should be supported and placed in natural position as far as possible with splints and bandages.
6. Make immediate proper arrangements to transport the patient to a hospital or to a qualified doctor in the vicinity It should however be remembered that the first aider need not to be a doctor. So he should never take upon himself the duties and responsibilities of a doctor. His responsibilities are over as soon as proper medical aid is available.
7. The injured should be given as much rest as possible and his body should be kept in a restful position.
8. In case to take out poison first.
9. In case of fracture the broken part should be saved from movement till proper medical aid is available.
10. Offer warm milk or tea if the patient is in senses he may be given a cup of a warm milk or tea.
11. Full knowledge of anatomy is essential for giving first aid. The first aider must have complete knowledge of anatomy and physiology. It will enable him to render proper first aid to the injured.

Do not assume the role of doctor. The first aider should remember that he is not a doctor So he should never take upon himself the duties and responsibilities of a doctor.

### **Contents of a first aid box**

The first aid box should contain the following equipments and medicines to enable the first aider to render effective timely appropriate aid.

### **Check your progress**

Notes : a) Write your answer in the space given below

b) Compare your answer with the those given at the end of the unit

1. The main aim of first aid is

a) Preserve life    b) promote recovery    c) prevent worsening    d) All the above (    )

2. Could you mention a few scope of first aid?

3. The essential quality of the first aider is

a) skilful    b) resourceful    c) quick    d) All the above (    )

### **5.6 First aid Equipment or apparatus**

- Clean cotton wool
- Needle
- Bandages
- Tweezers
- Safety pin
- Measuring tape
- Thermometer
- Scissors
- Camel hair brush
- Pads of various sizes
- Tourniquet
- Adhesive dressings
- Spoon
- Graduated glass

## **5.7 FRACTURE –causes and remedy**

Fractures are the commonest injuries involving the bones. A fracture is a break in the normal continuity of a bone. There are several types of fractures but they are generally classified as

1. Simple or closed: A simple fracture is a clean break in the bone without the ends puncturing through the skin
2. Compound or open: A compound fracture is one in which the broken ends of bones are fragmented or shattered into many pieces. This may be simple or compound
3. Communicated: A bone is broken into several pieces
4. Impacted: The broken ends of the bones are driven into one another and it is called as impacted
5. Greenstick: A greenstick fracture occurs mostly in young children. The bone may be cracked and bent without breaking completely across
6. Depressed In a depressed fracture the upper parts or sides of the skull or broken part of the bone is driven inwards
7. Spiral fracture It results when a bone is broken by twisting force
8. Multiple fracture multiple fracture means a bone is broken in more than one place

### **Symptoms of Fractures**

1. Pain at or near the seat of fracture
2. Swelling around the seat of fracture
3. Limitation of normal movement
4. Deformity of the limb
5. Irregularity of the bone

6. Crepitus (body grating) may be heard or felt
7. Unnatural movement at the seat of the fracture

### **Treatment of fractures**

1. Immobilize the injured part to prevent further damage
2. Use the uninjured part of the patient's body as splint
3. Place thick padding using sterile cotton, folded towels, scarves socks and to fill spaces between two parts of the paddy.
4. Avoid having a bandage directly over a fractured part
5. Bandages and signs should not be tight that they cut off the blood circulation
6. Hospitalize the injured individual

### **Splinting Prevents**

- a) Motions of fractured fragments thus reducing pain
- b) Further damage of muscle nerves blood vessels by broken ends
- c) Laceration of skin broken bones
- d) Restriction of excessive blood flow at the site of fracture

A splint is a device to prevent the injured part from moving

The following are the rules of splinting

- Remove clothing form the area of suited fracture or dislocation
- Infrastructure the splint should immobilize the bone above or the bone below the injured fracture
- In dislocation or sprain the splint should immobile the bone above or the bone below the injured joint



- During splint application move the limb as little as possible
- Straighten a severely deformed limb with constant gentle, manual traction so that the limb can be incorporated into a splint
- If gentle traction increases the injured athletes pain apply splint only in the position of deformity
- In neck and spine injuries correct deformity only as much as necessary. Avoid airway obstruction
- Cover all wound with a dry sterile dressing before applying splint
- Pad a splint to prevent local pressure
- When in doubt Splint

The manage skeletal injury Traction may be given

### **Traction**

Traction is defined as the action of drawing or pulling on an object. Traction if excessive can be very harmful to the injured limb. When applied correctly traction stabilizes the bone fragments and improves overall alignment. Do not attempt to reduce fracture

When applied if the athlete resists the traction or if it causes more pain stop the traction and apply splint to the injured limb.

### **Dislocation**

Definitions: dislocation is displacement of the ends of two bones at their joint so that the joint surfaces are not in proper contact generally knee elbow shoulder lower jaw get dislocated.

### **Causation**

A forcible extension at a joint cause dislocation. A sudden fall may also cause dislocation.

## **Symptoms**

Dislocation of bone causes severe pain The affected part gets swollen . The affected part loses its power of functioning. The part is deformed. The part becomes motionless Injuries to the capsules and ligaments a joint place sometimes tearing of muscles and tendons occurs.

## **Treatment**

- This part should be tightened with a cold water soaked bandage.
- If the coldwater soaked bandage does not relieve the pain the affected part should be fomented.

If even the fomentation does not prove of any use in reliving the pain a doctor should be consulted.

## **5.8 First aid related to...**

### **Burns and Scalds**

1. Remove the burnt clothes carefully Do not remove clothes from above the vesicles formed due to burns
2. Don't disturb vesicles
3. Cover the burnt part of the body with clean cloth
4. Keep the patient warm with blanket
5. Use splints and slings to support the burnt part of the body
6. Treat the shock
7. Call the doctor for help

If the child has burnt with acids wash the burnt part with water or water mixed with soda. If it is burnt by alkali (lime) cleanse the part burnt wash it with water mixed with lemon or with warm water

## **Fainting**

1. Symptoms of fainting
2. The patient becomes pale
3. Skin becomes cool
4. There will be sweating of the forehead
5. Respiration becomes weak
6. The patient may become unconscious
7. Pulse becomes weak

## **Treatment**

1. Lay down the patient on the floor and keep his feet raised so that more blood may enter the head
2. Give fresh air by open doors and windows do not let other children crowd around him
3. Take the child to a cool place
4. Keep hands and feet of the fainted child warm
5. Give smelling salt
6. Stop bleeding if any
7. Do not give any stimulant

## **Snake Bite**

### **First Aid**

1. Call the doctor at once
2. Recognize the kind of the snake that has bitten

3. If the snake is poisonous make every effort to avoid from position entering into the body. For example if the snake has bitten in the leg or arm stop the flow blood by means of tourniquet The tourniquet should be between the wound and heart . take a rubber pipe or an extensible lace or handkerchief and prepare the tourniquets Keep this at its place for 20 minutes and then loosen it and again fasten it strongly Do this till the doctor arrives
4. Apply potassium Permanganate on the wound. Make wound of  $\frac{3}{4}$  inches deep in the spot of bite with a sharp knife or blade and rub the particles of potassium permanganate.
5. Give strong coffee tea or hot milk if patient can swallow it
6. Give him courage so that he may not fear the snake bite

## **Rabies**

### **First aid for dog bite**

1. Call for the doctor
2. Wash the wound with water and soap
3. Apply carbolic acid with a match stick at ever place of bite inside and outside the wound
4. Burn the wound with hot iron or knitting needle apply potassium permanganates silver Nitrate or strong Nitric Acid
5. Get all information about the bite and the dog
6. Find out whether the dog has bitten of its own accord or when it was troubled
7. I the dog belongs to some person ask him to keep it tied so that it may be inspected by the doctor
8. Get anti rabbis treatment with Anti Rabbis vaccine (ARV)

### **Check your progress**

Notes : a) Write your answer in the space given below

b) Compare your answer with the those given at the end of the unit

1. The symptoms of a fracture is ...

a) pain b) swelling c) irregularity of the bone d) all the above ( )

2. What is dislocation?

3. The symptom of fainting is..

a) Becomes pale b) sweating forehead c) weak respiration d) All the above ( )

4. What kind of first aid do you recommend for the snake bite?

### **Electric Shock**

#### **First Aid**

1. Do not allow persons to crowd around the victim
2. Lay him down on a blanket in a cool place
3. If he becomes unconscious place his head between his knees
4. Raise the feet loosen the light clothing around the neck in the loins and at the chest
5. Put cold water drop by drop in his mouth
6. Call for the doctor at once
7. Try to keep the patient vigilant
8. Protect him from anxiety and provide encouragement and comfort
9. Give artificial respiration if needed
10. Treat the burns

## **Precautions**

As electric shocks take place in houses general hence the parents should be properly trained. They should stop the flow of electric current by switching off the main. It is not possible put on dry rubber gloves coat or cloth and then with the help of bent stick or dry rope remove the child caught by electricity. Remove the plug or break the electricity. Remove the plug or break the electric wire by drawing it out. Do not cut it with a knife

## **Bleeding**

Arteries veins and capabilities are the vessels that carry blood Arteries carry blood from heart to the various organs of body. Capabilities are the vessels that connect arteries and veins. These are so small that they cannot be seen by naked eye, except under a microscope. Veins are the vessels that carry blood from various organs to the heart. Bleeding occurs when any of these vessels is cut. Bleeding therefore if of three kinds.

- Arterial Bleeding
- Capillary bleeding
- Venous bleeding

In the arterial bleeding the blood that oozes out with the heart beat is of bright red colour. But in the capillary bleeding it is in dark purple and takes place slowly. In the case venous bleeding blood is dark purple but comes out in a fast flow.

The blood is dark purple because of the ate products that have been collected in it. Arterial bleeding is hard to control and very serious and needs also immediate first aid and treatment.

## **First aid for capillary bleeding**

1. Dip the part of the body in cold water.
2. Tie the wound with wet clean cloth.

### **First aid for venous bleeding**

1. Lower the wounded part of the body.
2. Apply tourniquet on the wound in the direction opposite to heart.
3. Tie a clean cloth dipped in antiseptic solution.

### **First aid for Arterial Bleeding**

1. Place a compress over the wound and apply direct pressure with both the thumbs.
2. If blood does not stop oozing out, apply pressure at the pressure point nearest to the heart use tourniquet.
3. Raise the wounded part above so that less blood may come out.

### **The pressure points are**

1. Carotid pressure point-Where the branches of aorta on the both sides of the windpipe send blood to the head.
2. Sub clavation pressure point – Where the branches of Aorta come out of the collar bone cross the first rib and reach the attempt.
3. Brachial Pressure point The arteries of the arm line lie on the inner side of the biceps and they carry blood to upper extremities.
4. Femoral pressure point –It lies on the iliac artery which is a branch of abdominal aorta. It is just in the middle of the bend of the thigh.

### **First aid for bleeding from the nose**

Bleeding from the nose is caused by heat or injury on the nose. The following points should be kept in mind while giving first aid for bleeding nose.

1. Seat the child in front of an open window and bend his head backwards with his hand raised up.

2. Loosen the tight clothing around the neck and chest.
3. Ask the child not to breathe through nose but through the mouth.
4. Place the feet in warm water.
5. Apply cold compress over the neck.
6. Do not allow the child to sneeze.

### **First aid related hemorrhage:**

Bleeding is the name commonly used to describe blood loss. It can refer to blood loss inside the body (internal bleeding) or blood loss outside of the body (external bleeding). Blood loss can occur in almost any area of the body.

### **Prevention:**

1. Maintain blood pressure as low in the normal range as possible
2. Avoid blood thinning or anti-clot medications including aspirin, when possible. This is especially critical for patients with recent growth or hemorrhage.
3. Stay away from roller coasters or any activity inducing strong gravitational force.
4. Stay stress free.

### **Treatment:**

Place pressure directly on the wound. This can be accomplished by placing a sterile gauze dressing or a clean handkerchief on the bleeding points and pressing firmly with the flat of one's hand or with one's fingers. If the bleeding is secondary to a very severe laceration in the arm or in the leg, a tourniquet may be required. This should be applied only as a last resort if the bleeding cannot be controlled by direct pressure.

#### Treatments of external bleeding

- Direct pressure on wound
- Direct pressure on artery or vein
- Elevating bleeding limb



- Styptics
- Ice cold water

### **Treatments for internal bleeding**

- Patient lying down
- Intravenous morphine
- Emergency treatment
- Emergency hospitalization

### **First aid to respiratory discomfort**

Respiratory arrest is the medical term for the mildest form of respiratory compromise wherein there are breathing difficulties and psychological experiences. It is characterized by breathing difficulties and psychological experiences associated with such difficulty, even though there is no physiological basis for experiencing respiratory distress. Respiratory distress may easily turn into a medical emergency when the levels of carbon dioxide in the body increase causing symptoms of respiratory arrest. Respiratory arrest is a condition where the lungs stop contracting efficiently resulting to the cessation of breathing, thus oxygen is not delivered to the rest of the body. In some cases, symptoms for respiratory distress are apparent. Clinically, it may appear that the patient is unable to ventilate and/ or oxygenate. Respiratory distress is often associated with physical illnesses including acute respiratory distress syndrome and infant respiratory distress syndrome. Respiratory distress is the most common breathing emergency.

### **Causes:**

- Airway obstruction
- Pneumothorax, whether open or closed
- Tension pneumothorax
- Choking
- Electrocutation
- Pulmonary contusions
- Flail chest

- Asthma
- Diaphragmatic hernia
- Allergic reactions
- Emotional distress
- Drowning

**Symptoms:**

- Increased breathing rate signifying an individual is having breathing troubles or not getting adequate oxygen
- Cyanosis (bluish) around the mouth, inside of the lips, or on the fingernails, which may also appear pale or gray at times
- Grunting sound upon exhalation
- Nasal flaring indicating labored breathing
- Wheezing sounds that denotes tighter air passages
- Chest retractions which appears to sink in below the neck and/ or under the breastbone for every respiration
- Increased sweating on the head
- Cool, clammy skin

**Treatment:**

- Call for emergency medical assistance immediately.
- Check for the casualty's pulse, airway and breathing.
- To check for pulse, place two fingers on the groove of the neck.
- To check for any airway obstruction, place two fingers on the forehead and two fingers on the chin and slightly tilt the head.
- To check for breathing, place own cheek in between the nose and mouth of the casualty

and feel for breathing on the cheek. Watch for rise and fall of the chest. Do this for 5-10 seconds.

- If there is no breathing, give mouth-to-mouth breathing.
- With the airway open, pinch the nostrils and seal the victim's mouth with own mouth. Give two rescue breaths.
- Perform CPR if necessary.
- Do not leave the victims of respiratory distress alone until professional help arrives.

### **Treatment of unconsciousness**

#### **What is unconsciousness?**

Unconsciousness is when a person suddenly becomes unable to respond to stimuli and appears to be asleep. A person may be unconscious for a few seconds (fainting) or for longer periods of time. People who become unconscious don't respond to loud sounds or shaking. They may even stop breathing or their pulse may become faint. This calls for immediate emergency attention. The sooner the person receives emergency first aid, the better their outlook will be.

#### **Causes:**

Unconsciousness can be brought on by a major illness or injury, or complications from drug use or alcohol abuse. Common causes of unconsciousness include:

- a car accident
- severe blood loss
- a blow to the chest or head
- a drug overdose
- alcohol poisoning

A person may become temporarily unconscious (faint) when sudden changes occur within the body. Common causes of temporary unconsciousness include:

- low blood sugar
- low blood pressure

- syncope (loss of consciousness due to lack of blood flow to the brain)
- dehydration
- problems with the heart's rhythm
- neurologic syncope (loss of consciousness caused by a seizure, stroke, or transient ischemic attack)
- straining

**Treatment:**

1. Check whether the person is breathing. If not go for an immediate help. If he is breathing, position the person on their back.
2. Raise the person's legs at least 12 inches above the ground.
3. Loosen any restrictive clothing or belts.
4. Check the person's airway to make sure there's no obstruction.
5. Check again to see if the person is breathing, coughing, or moving. These are signs of positive circulation.

**Treatment of heat stroke**

Heat stroke is the most serious form of heat injury and is considered a medical emergency. Heat stroke can kill or cause damage to the brain and other internal organs. Although heat stroke mainly affects people over age 50, it also takes a toll on healthy young athletes. Heat stroke results from prolonged exposure to high temperatures usually in combination with dehydration which leads to failure of the body's temperature control system. The medical definition of heat stroke is a core body temperature greater than 105 degrees Fahrenheit, with complications involving the central nervous system that occur after exposure to high temperatures. Other common symptoms include nausea, seizures, confusion, disorientation, and sometimes loss of consciousness or coma.

**Symptoms:**

- Rapid heartbeat, which may be either strong or weak
- Rapid, shallow breathing
- Unconsciousness
- Seizures
- Behavioral changes such as confusion, disorientation, or staggering
- Red, hot, and dry skin
- Muscle weakness or cramps
  
- Nausea and vomiting
- Throbbing headache
- Dizziness and light-headedness
  
- Lack of sweating despite the heat

**Treatment:**

The initial treatment of patients with heat exhaustion involves stabilization in a cool area. Unless the factors leading to heat exhaustion are corrected swiftly, affected patients can progress to heatstroke. Patients who are significantly dehydrated, who are hyponatremic, or who have mental status changes or central nervous system irritability should be transferred to an appropriate medical facility. Oral rehydration solutions containing sodium may be used in the field to treat most cases of mild dehydration. It is essential that physicians recognize the signs of hyponatremic heat exhaustion and avoid administering hypotonic fluids (as regards sweat). Repletion of sodium with normal saline should be performed gradually. Symptoms of heat exhaustion often resolve within two to three hours. Slower recovery should initiate transfer to a medical facility and a careful search for missed diagnoses. Cooling methods generally are categorized as external or internal. External methods include evaporative and immersion cooling, with evaporative methods being most commonly used in the field. In evaporative cooling, a mist of cool water (15°C [59°F]) is sprayed on the patient's skin, while warm air (45°C [113°F]) is fanned over the body. Cooling rates with this technique have been measured at 0.31°C (0.56°F) per minute. Immersion cooling can be achieved with an ice bath, or by using cooling blankets in

conjunction with ice packs placed on the axilla, groin, neck, and head. Although immersion methods are thought to be less effective than evaporative cooling, direct comparison studies are lacking. Drawbacks of immersion include the occurrence of peripheral vasoconstriction and shivering when skin temperature is cooled below 30°C (86°F) although this response may be overcome through peripheral massage. Immersion cooling also may make it difficult to access a patient. Despite these concerns, however, immersion may be a preferable technique when treating patients for whom exposure of the skin is culturally inappropriate.

### **Check your progress**

Notes : a) Write your answer in the space given below

b) Compare your answer with the those given at the end of the unit

1. Suggest a first aid to respiration discomfort.
2. How can we bring back the patient from the unconsciousness?

## **5.9 Let us sum up**

This unit attempts to highlight the concept of first aid and its equipments and the need and its essentiality has been well focused. Especially this unit gives you a brief concept of the first aid with treatment is pointed out here.

### **5.10 Unit end activities**

1. Enumerate the principles of first aid
2. Suggest a treatment for respiratory discomfort.

### **5.11 Answer to check your progress**

**1.d**

**2. Refer the course material**

**3.d**

**4.d**

**5. Refer the course material**

**6.d**

**7. Refer the course material**

**8. Refer the course material**

**9. Refer the course material**

### **5.12 Suggested Readings**

1. Singh, Ajmer, et.al “Essentials of Physical Education”, kalyani publishers, New Delhi, 2003.
2. Shivendra Chandra, Sothi, Puri Krishnan “Health Education and Physical Education”, Surject Publications Delhi, 2005.
3. Show, Dhanajoy and Kaushick Seema, “Lesson planning-Teaching Methods and class Management in Physical Education”, Khal Sahitya Kendra, New Delhi, 2007.
4. Dash. B.N (2007), Health and Physical Education, New Delhi, Neelkamal publications

## **UNIT-VI**

### **YOGA, PHYSICAL EXERCISE AND FITNESS**

**6.1 Yoga-Meaning**

**6.2 Objectives**

**6.3 Aims and Objectives of yoga**

**6.4 Eight limbs of yoga**

**6.5 Different Asanas**

**6.6 Exercises and its Types**

**6.7 Difference between Yogic Exercises and Physical Exercises**

**6.8 Effects of Physical exercise on various systems**

**6.9 Let us sum up**

**6.10 Unit end activities**

**6.11 Answers to check your progress**

**6.12 Suggested Readings**



## 6.1 Meaning

Historically, this term refers to a wide range of bodily postures that have been transmitted by teachers in India for thousands of years. Many of these postures or asana have been defined by the classic Hatha Yoga tradition, the tradition in which the word Yoga comes from. Hatha means union, “Ha” means sun and “tha” means moon. Therefore “Hatha Yoga” means a balanced union, a system for creating the balanced well being of the total person as Yoga joins the mind, body, and spirit into a balanced whole.

While we are on the path to achieve our highest spiritual potential, asana practice promotes structural stability, physiological immunity, and emotional health, as it helps us restore and develop balance, stability, strength, flexibility, skeletal alignment, and mechanical freedom.

### Definition of Yoga

- |   |                       |
|---|-----------------------|
| “Checking the impulses of mind is yoga” | <b>-Patanjali</b>     |
| “Yoga is attaining the pose”            | <b>-Ved vyas,</b>     |
| “Yoga is skill in actions.”             | <b>-Lord Krishna.</b> |

“Yoga is the way or method through which internal and external facilities of man meet in totality and changes occur and by which may achieve God or feel his existence and may become the part of Him”. **-Sri Aurobindo,**

“Yoga is that method or activity (sadhna) by which we realize the oneness of human soul with god and human meet God and feel its knowledge (Gyan).” **-Swami Shiva Nandji,**

“The meeting of human being with God is Yoga.” **-Nukeshwar Majumdar,**

## 6.2 Objectives

After learning this unit, you will be able to:

- Describe the meaning, aims and objectives of Yoga
- State the scope of and importance of Yoga

- Know the benefits and types of yoga
- Understand the concept of physical exercise difference between physical exercise and yoga

### **6.3 Aim and objectives of Yoga**

The aim of yoga is control over the mind. A man who cannot control his mind will find it difficult to attain divine communion, but the self-controlled man can attain it if he tries hard and directs his energy by the right means.

The main aim of yoga is integrating the body, mind, and thoughts so as to work for good ends. Modern life style leads to diseases, which are mostly due to poor food habits, heavy daily routines and to air and water pollution in turn easily affect the used to preserve are to destroy. With a matchstick one can light a candle and illuminate the house.

At the same time it can also be used to torch a house. Like that, our mind can also be used for either good or bad purposes. Many poets have compared our minds with a monkey. Monkey would not sit at one place. It will jump here and there. Like a monkey, our thoughts will be always wandering, and ultimately that will disturb the mind and is kept without peace.

Through systematic and regular Yogic practices, the body may be made healthier and its resistance power to fight against the diseases could be enhanced. By practicing yoga the mind will get sharpened and the concentration and memory power may developed. Thus, minds could be canalized for thinking the right good thoughts. Then the good and healthy thoughts will develop in the right direction. Yoga will pave the way for an individual to do any action peacefully and perfectly.

The main objectives of the Yogic practices are to make one free from diseases, ignorance, egoism, miseries the affiliations of old age, and fear of death etc.

### **6.4 ELGHT LIMBS OF YOGA (Astanga Yoga)**

There are eight limbs of yoga to secure purity of body, mind and soul. They are, 1. Yama, 2. Niyama, 3. Asana, 4. Pranayama, 5. Prathyaghara, 6. Dharana, 7. Dhyana and 8. Samadhi

### **1. Yama:**

(Universal moral commandments) Yama means restraint or abstention, it has five moral practices.

- (i) **Ahimsa**- (Non-Violence) means not to hurt any creature mentally or physically through mind speech or action.
- (ii) **Satya**- (Truth) is the presentation of a matter as perceived with the help of the sense organs.
- (iii) **Asteya**- (Non-stealing) means not to cover and acquire physically, mentally or by speech others possessions.
- (iv) **Brahmacharya**- (continence) Brahmacharya does not mean lifelong celibacy, but moderation in sex between married couples.
- (v) **Aparigraha**- (Non-Coveting) means abandoning wealth and means of sensual pleasures.

### **2. Niyama (self purification by Discipline) Physical and mental rules of conduct towards oneself.**

- (i) **Saucha**- Purity means internal and external purification of the body and the mind
- (ii) **Santosa**-contentment is a state of mind by which one lives happily and satisfied in a congenial or uncongenial atmosphere.
- (iii) **Tapas**-Austerity is the conquest of all desires or sensual pleasures by plasticizing purity in thought, speech and action.
- (iv) **Swadhaya**-Study of the self means exchange of thoughts in order to secure purity in thought and accomplish knowledge.
- (v) **Isvara Pranidhana**-Dedication to the Lord it is pure devotion to God and surrender of all actions to him.

### **3. Asanas**

It has been described as meaning to sit comfortably without any movement for long in one pose. Whatever may be the type of Asana the back bone, Forehead and chin should always remain (straight). To master the asana one should be able to sit comfortably at least for three hours at a stretch. Among a number of asana the Sidhasana, Padmasana, and swastika asana are considered the best.

When a person masters an asana's he is not affected by seasons, weather cold and hot rain like disturbances.

#### **4. Pranayama:**

A complete cycle of respiration is called Pranayama. It is complete respiratory system. It is the method to take the air inside the body i.e. inhalation and after some pause bring the air out of the lungs i.e., exhalation in a particular way.

#### **5. Pratyahaar**

Through our various sense organs we use things according to our interest and attitude desire and liking are eyes to see the beauty hand to touch nose to smell, tongue to taste, ear to hear voice. But when our sense organs become detached they settle down in the heart. This situation is known as pratyahaar.

#### **6. Concentration**

Human being has a tremendous strength and energy in them. They can achieve anything. Due to lack of concentration within one is unable to get many powers in life. Through concentration one achieves power. Dharana is concentration of the mind on some object.

#### **7. Meditation**

When takes the concentration form of meditation the aspirant marches forward continuously and without pause towards his goal and becomes inseparable from his aim.

#### **8. Samadhi**

It is the highest attainment. It is the worshipper and worshipped become one. There remains no difference between the two i.e., one who is performing Dhyana and for the object of Dhyana. One soul becomes an integral part of God.

#### **Importance/ Advantages of yoga**

1. Yoga is easy to perform. Anybody can take part in it and perform according to one's capacity and capability. Yoga does not require equipment and implements.
2. Yoga practices can be performed and practiced by everyone whether child or adult man or woman young or old, rich or poor without reservation or without any difficulty.
3. By doing all activities pertaining to all sort of exercise such as tension, contraction, expansion, twisting are performed the exercises and activities removing tension, worries etc, all sorts of tension and fatigue is removed. The strength and energy is recovered and regained.

4. Yoga has a special place and importance to refresh the mind and body and to regain the lost or spent energy from spiritual point of view.
5. Due to yoga, glands secretion becomes normal body organs get stronger and energetic. Yogi remains ever young with vigour and vitality.
6. Stomach in the human organs (in the human body) is the mother (originator) of all diseases and sickness. It is the root cause of all illness i.e., all diseases originate from the stomach. Due to yogic exercises particularly pertaining to stomach, the stomach becomes clean digestion becomes regular and constipation is removed.
7. Vertebra (Spinal cord) remains erect. Asanas make it flexible. Nerve strength (energy) is improved.
8. Ladies become beautiful charming in perfect shape and size fully developed in all their organs fit and attractive with elegant gait. They remain ever young. Their belly remain under control and in good shape even after becoming a mother.
9. Yoga helps in the growth and development if intelligence of a person. He develops and improves food habits and behavior. He tries for self improvement.
10. Yoga makes the man and woman self controlled. They do not indulge in extremes. Their thinking is pure and refined. It helps in achieving god mental as well as physical health.
11. Yoga controls and regulates the respiration and respiratory systems as a whole. It provides strength to the heat and lungs. It purifies and regulate the blood in the body. Concentration of mind is improved. Will becomes strong and stable.
12. Yoga destroys the causes of diseases. It protects and safeguards the person against diseases. Body becomes disease free strong and healthy
13. The eye sight is improved considerably. If already weak it becomes better.
14. Pranayam is an indispensable activity in yoga which destroys the whold and total ailment of the body. The body becomes beautiful clear, clean, strong, energetic and graceful. There is marked improvement in digestion. The mind becomes controlled and stable. The intelligence and memory is improved and developed.
15. There are several systems in the world by which diseases can be cured and treated. But to cure diseases through yogasanas has no parallel. Yoga destroys the diseases and illness.

### General notes for the Practitioner

1. Breathing - Always breathe through the nose.
2. Awareness - This is as essential to the practice of asanas as it is all practices, Physical, pranic, mental, emotional, psychic and spiritual.
3. Relaxation - When feeling physically or mentally tired.
4. Sequence - Asanas, pranayamas and meditation.
5. Counter pose - Forward to Backward, Left to right.
6. Time to practice - Brahammuhurta, two hours before the sunrise.
7. Place of practice - well ventilated room, calm and quite,
8. Outdoors - surrounding should be pleasant, a beautiful garden with trees and flowers.
9. Blanket - Insulator between the body and the earth.
10. Cloths - to wear loose, light and comfortable clothing.
11. Bathing - Before bath will help to improve the effect of the asanas.
12. Empty stomach - Try to avoid using laxative drugs.
13. Abdomen-one quarter - empty, one quarter-water and two quarter food.
14. No straining - beginners may find their muscles stiff at first
15. Age limit - above 10 years to all age groups
16. Contra indications - fractured bone, chronic ailments and diseases as stomach Ulcer, Tuberculosis or hernia and recuperating from operations.
17. Termination of asanas - if there is excessive pain in any part of the body the asanas should be terminated immediately.
18. Limitation for women - during the first 3 months of pregnancy to do the few asanas which give the pressure in the abdominal region should be avoided by women, during menstrual periods no asanas should be practiced, because the undue pressure exerted during asanas may cause increased bleeding.

## 6.5 DIFFERENT ASANAS

There is a large number of asana. According to Charandas, there are eighty four thousand asanas. Some of the asanas are very useful and important from the view point of physical mental and spiritual growth of an individual. We shall discuss in brief a few important asanas.

### Methods of Doing Asanas

Position

1. Sitting position
2. Supine Position
3. Prone position
4. Standing position

### I. Sitting position

#### A. Padamasana



**Posture- Lotus posture**

**Position- Long sitting position**

#### Method

1. Sit and spread out both legs to the front. Hand to be one the side palms on the ground and fingers joined together.
2. Slowly lift the right toe with the left hand and right ankle with the right hand and place it on the left thigh.
3. In the same manner, hold the left toe and ankle. Place it on the right thigh.
4. Place the hands on the knees in meditative posture. Close the eyes or look to the front.
5. In the reverse order remove the left leg first from the thigh.

6. Then remove the right leg too and assume the initial position.

### **Benefits**

#### **General**

1. Padmasana is used for mediation, prayer, and worship and for pranayama practice.
2. It develops the physical and mental stability.
3. This asana helps for the players to obtain mental control.
4. Padmasana keeps a person young.

#### **Physiological**

1. The abdominal region receives more supply of the blood.
2. Padmasana improves the digestion process.
3. It activates the functions of kidney.

#### **Therapeutic**

1. Padmasana relieves constipation, and indigestion
2. It is a very good asana for curing knee ailments.
3. Padmasana is useful in curing the flatulence i.e gastric trouble at the stomach.
4. It also cures pile complaints.

### **B. Yogamudhra**



#### **Posture-Psychic Union Posture**

#### **Position-Length sitting position**

#### **Method**

1. Slowly bring the right leg and place it on the left thigh. The heel of the right foot should as much as possible touch the groin.



2. Slowly bring the left leg and place it on the right thigh. The heel of the left foot should as much as possible touch the groin
3. Slowly bring hands back and hold the right hand at wrist by the left hand.
4. Slowly bend the trunk forward until the forehead touched the ground or nearly touches the ground.

### **Benefits**

#### **General**

1. Yogasana is very useful for focusing our mind in a particular object.
2. Separates the individual vertebrae from each other, thus allowing the spinal column more flexible.

#### **Physiological**

1. Yogasana activates the kidneys, liver, pancreas and adrenal glands
2. It is useful for a good flow of fresh blood to the spinal nerves and muscles.
3. It increases the functions of the circulatory and respiratory systems.
4. The entire nervous systems are toned up.

#### **Therapeutic**

1. Yogasana is useful for curing obesity
2. It is a good remedy for constipation
3. It is a very good asana for pile complaints.
4. It can check and even cure diabetes.

### **C.Matsyasana**



**Posture: Fish Posture**

**Position: Long sitting position**

#### **Method**

1. Slowly bring the right leg and place it on the left thigh. The heel of the right foot should as much as possible touch the groin.

2. Slowly bring the left leg and place it on the right thigh. The heel of the left should as much as possible touch the groin.
3. With the support of the arms and elbows, slowly and backward and lie down flat on the ground.
4. Slowly bring the hands and place the palms near the shoulder (elbow facing upward). With the help of hand support slowly lift the chest upwards and rest the centre of the head support slowly lift the chest upwards and rest the centre of the head on the ground and arch the back as much as possible.
5. Slowly bring the hands forward and place the palms on the feet.

### **Benefits**

#### **General**

1. Matsyasana enlarges the thoracic cage.
2. It strengthens the spinal column
3. It gives more flexibility to the neck region, hip and knee joints.

#### **Physiological**

1. Matsyasana allows the flow of more blood to the thoracic region.
2. It regulates the function of the thyroid gland
3. It regulates the free flow of the breathing process.

#### **Therapeutic**

1. Matsyasana is useful in curing asthma.
2. It is useful for curing the headache and sinus-problems
3. It helps to reform the disorder of kyphosis.
4. It is very good asana for backache patient.

### **D. Paschimottanasana**



**Posture: Back-Stretching posture**

**Position: Long Sitting Position**

**Method**

1. Slowly bring the hands upwards above the head through sideways (without bending elbows)
2. Slowly bring the hands downward on forward direction and try to catch the big toes with fingers (if this is not possible try to hold the ankles, as near to the feet as possible)
3. Slowly bend the body forward and try to touch the knees with the forehead (without any strain anywhere in the body.)

**Benefits**

**General**

1. Paschimottanasana strengthens the hamstring, calf, and back muscles.
2. It removes excess fat in the abdominal region
3. It gives more flexibility to the vertebral column.

**Physiological**

1. Paschimottanasana activates the kidneys, liver, pancreas and adrenal glands
2. It is useful for a good flow of fresh blood to the spinal nerves and muscles.
3. It increases the functions of the circulatory and respiratory systems.

**Therapeutic**

1. Paschimottanasana is a good remedy for constipation
2. It can check and even cure diabetes.
3. It is useful for curing the obesity.
4. It is a very good asana for the pile complaints.

**II. Supine Position**

**A. Halasana**



**Posture: Plough Posture****Position: Supine Position****Method**

1. Raise the legs slowly upto 90-degree and hold them in the position for a few seconds.  
Raising the legs with straight and together.
2. Gently lower the legs behind the head until the toes are touching the ground.
3. Extend the feet a little further behind the head with toes pointing outward.

**Benefits****General**

1. Halasana is extremely beneficial to the spinal column
2. It develops the memory and concentration power.
3. It reduces the excess fat at the stomach region.

**Physiological**

1. It regulates the functions of circulatory and respiratory systems
2. It activates the functions of pituitary gland, which is the master gland that controls all the ductless glands functions.
3. It increases the more amount of blood flow to the head region.

**Therapeutic**

1. Halasana relieves backache, low back pain and rheumatism,.
2. It regulates the nervous debility
3. It is a good remedy for menstrual disorders and obesity.

## **B. Sarvangasana**



**Posture: Shoulders stand posture**

**Position: Supine Position**

### **Method**

1. Raise the legs slowly upto  $90^{\circ}$ , and hold them in the position for a few seconds. While raisin maintain the legs straight and together
2. Raise the trunk slowly the support of the hands with the palms placed at the centre of the back.
3. Hold the body at an angle of  $90^{\circ}$  with head, shoulder and upper arm alone on the ground.
4. Maintain the same body position. Keep the total body perpendicular to the ground.

### **Benefits**

#### **General**

1. Sarvangasana develops the memory and concentration power.
2. It reduces the excess fat at the stomach region
3. It gives more flexibility to the spinal column

#### **Physiological**

1. Sarvagasana particularly stimulates the thyroid gland.
2. It has a beneficial effect on the endocrine and digestive system.
3. It activates the functions or pituitary gland, which is the master gland that controls all the ductless glands functions.
4. It increases the more amount of blood flow to the head region.

### **Therapeutic**

1. Sarvangasana relives headaches, asthma etc.
2. It is a very good asana to relieve impotency and throat ailments.
3. It is a good remedy for menstrual disorders, varicose veins and obesity.
4. It regulates the nervous debility

### **III. Prone Position**

#### **A. Bhujangasana**



**Posture: Cobra posture**

**Position: Prone position**

#### **Methods**

1. Slowly bring the arms side wards nearer to the chest and place the palms on the floor with fingers pointing towards head.
2. Slowly raise and make an arch backward on the head, neck and shoulder as much as possible.
3. Slowly raise the chest as mush a possible in such a way that the lower abdomen should be in touch with the ground.

#### **Benefits**

##### **General**

1. Bhujangasana strengthens the neck and back muscles.
2. It will give more flexibility to the vertebral column.
3. It will develop the concentration and memory power.
4. It will enlarge the thoratic cavity.

### **Physiological**

1. Bhujangasana activates the functions of the thyroid gland.
2. It regulates the free flow of breathing process.
3. It allows the flow of more blood to the thoracic region

### **Therapeutic**

1. Bhujangasana stimulates the digestion
2. It relocates the slipped disc
3. It is a very good asana for neck pain
4. It helps to reform the vertebral disorder of khyposis
5. It is a good remedy for paralysis and rheumatism.

### **B. Salabhasana**

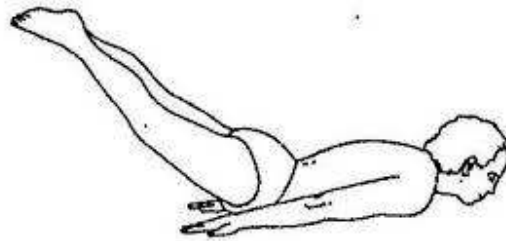

**Posture: Locust posture**

**Position: Prone position**

#### **Method**

1. Slowly raise the head, and place your chin on the floor
2. Gently raise the thighs and place the hands below the thighs with palms touching the floor
3. Slowly raise both the legs one or two feet above the ground level.
4. Maintain the pose for few seconds without any oscillation. In the final position try to relax the whole body as much as possible,

#### **Benefits**

##### **General**

1. Salabhasana will strengthen the back and abdomen muscles
2. It helps to make the maximum range of movements in all directions in the hip joint.
3. Salabhasana gives more flexibility to lower vertebrae in the spinal column

4. It develops the balancing power in the body.

### **Physiological**

1. Salabhasana brings a large supply of blood to the kidneys, heart, and lungs.
2. It activates the functions of digestive and excretory system particularly large and small intestine.
3. It activates the functions of liver and pancreas
4. It regulates the respiratory process.

### **Therapeutic**

1. Salabhasana relieves the low back pain to a great extent
2. It plays a vital role in curing impotency
3. It is useful in curing constipation
4. It is a very good asana for arthritis disorder
5. It is a good remedial asana for indigestion problem.

### **B. Dhanurasana**



**Posture: Bow posture**

**Position: Prone position**

### **Method**

1. Gently fold the right leg at knee and hold ankle with right hand
2. Slowly the left leg at knee and hold the ankle with the left hand
3. Raise the head, chest and thighs as high as possible by gradual application of force on the hands and legs
4. Raise the body and make a perfect back arch on the vertebral column as much as possible.



## **Benefits**

### **General**

1. Dhanurasana loosens the spinal column
2. It will strengthen the back and abdomen muscles
3. It develops the balancing power in the body

### **Physiological**

1. Dhanurasana stimulates the endocrine glands
2. Particularly it activates the function of liver, kidney and pancreas
3. It brings a large supply of blood to the kidneys, heart and lungs

### **Therapeutic**

1. Dhanurasana is useful for women suffering from irregular periods.
2. It is a very good asana for curing many disorders like asthma, diabetic, constipation, sexual debility etc.,

## **IV. Standing Position**

### **A. Trikonadana**



**Posture: Triangular posture**

**Position: Standing position**

### **Methods**

1. Place the right leg to the right side in such a way that the legs are 3 to 4 feet apart.
2. Slowly raise the arms sideward upto the shoulder level without any bend at the elbows with facing down.

3. Slowly bend sideways towards the right leg and try to touch the right foot or floor as much as possible with right hand.
4. Keeping the left arm perpendicular to the floor with the palm facing forward. Slowly turn the head and look up. If you feel stiffness at the neck, keep the head facing forward.

### **Benefits**

#### **General**

1. Trikonadana reduces the excess fat in the sideways
2. It improves the balancing power in the body

#### **Physiological**

1. Trikonadana regulates the digestive and circulatory systems
2. The spinal nerves are tone up thus it develops the concentration

#### **Therapeutic**

1. Trikonadana is helpful to reform the vertebral disorders scoliosis.
2. It is very useful in curing some of the functional and organic disorders like acidity, arthritis, heart diseases etc.

### **Check your progress**

Notes : a)Write your answer in the space given below

b)Compare your answer with the those given at the end of the unit

1. List out the eight limbs of yoga
- 2.The major positions of asanas are  
a)sitting b)supine c)prone) d )all the above ( )
- 3.Mention a few general benefits of supine position of yoga
- 4.The triangular posture is from  
a)Standing b) Sitting c) Supine d)Prone ( )

## 6.6 EXERCISE AND ITS TYPES

### Meaning of physical exercise

Exercise is the key to sound health. The activity of exerting your muscles in various ways to keep fit.

### Need and importance of Physical Exercise

- ❖ Exercise provides adequate quantity of oxygen and enables different organs of human body to function properly
- ❖ Exercise promotes the circulation of blood to all parts of the body.
- ❖ Exercise develops muscular systems in body
- ❖ Muscles can also be kept in tone.
- ❖ Toxic products are eliminated from the blood stream
- ❖ Exercise pep up metabolism
- ❖ Exercise stimulate the nervous system
- ❖ Exercise helps in the proper functioning of the organs in human body. It also makes them strong.
- ❖ Exercise brings joy to a man. It is an outlet
- ❖ Exercise is a natural thing for men and

### Types of Exercise

There are two major types of exercises namely Aerobic and Anaerobic.

#### Meaning of Aerobic Exercise

The literal meaning of aerobics is oxygen. Hence, aerobic exercise can be defined as the one which involves the use of oxygen to produce energy.

Aerobic activities are rhythmical exercise having large muscle groups involvement continuously in sequential manner. Physical activities such as **jogging, brisk walking, rowing, cycling, hiking or playing tennis, focus on increasing cardiovascular endurance skiting and swimming are aerobic exercises.**

#### Meaning of Anaerobic Exercises

Anaerobic exercises make the body to provide energy without using oxygen. High intensity workout such as **jumping, weight lifting, sprinting, short term muscles strength exercises are categorized as anaerobic exercises.**

### Difference between Aerobic and Anaerobic Exercises

Sl. No	Aerobic exercises	Anaerobic exercises
1.	It involves moderate intensity workout	It involves high intensity workout
2.	Activities performed for longer duration	Activities performed for short duration
3.	It involves only simple exercises	It needs more strenuous exercise
4.	Activities need more endurance	Activities need more speed and strength
5.	Activities performed for more than two minutes to an hour	Activities performed from some seconds to two minutes
6.	Oxygen is used to breakdown glucose	Oxygen make use of phosphocreatine which is stored in the muscles.
7.	It concentrates on strengthening and the muscles involved in respiration. It improves the circulation of blood and transportation of oxygen in the body, reduces blood pressure and burns fat.	It helps build strength and muscles mass, stronger bones and increases speed, power muscle strength and the metabolic rate as well; it concentrates on burning the calories, when the body is in rest.
8.	Energy is provided by carbohydrates and fats	Energy is provided by the Adenosine Triphosphate (ATP) and creatine Phosphate

### 6.7 Difference between Yogic Exercises and Physical Exercises

Yogic Exercises	Physical Exercises
The inner vital organs are benefited rather than muscular development	These bring in muscular development
Flexibility of the bones, especially the spinal cord is made possible by the asana	Flexibility of the spine or bones is not the purpose as for as exercises are concerned.
Development of basic fitness factors required by the common man is provided by yoga	Physical fitness such as strength, speed, stamina, skill, stability and suppleness are improved
Despite the static nature, yoga helps to develop cardio-vascular efficiency	These also develop cardio-vascular efficiency but vigorous nature of these may not be

	suitable for practice by different individuals.
These are essentially in individualistic.	These involve group practice
There is no spirit of competition	These involve encouragement to the spirit of competition
Practice like asana and pranayama release tensions in the body and bring control over autonomic functions and lead to peace of mind	Muscular tension is reduced. Emotional balance should be restored due to release of tension.
In advanced age, other vigorous activities are not possible yoga becomes very ideal. Yoga can be followed throughout life.	In advanced age, vigorous exercises cannot be done and hence not possible to follow. Continue physical exercise
These makes a man introspective	They make a man an extrovert
There is minimum expenditure of energy and does not give fatigue and bring about a feeling of freshness	A lot of energy is consumed in performing these exercises and they give fatigue and sometimes it may give bodily discomfort

## 6.8 EFFECT OF EXERCISE ON VARIOUS SYSTEMS

### Introduction

This section is to explore various changes in different system of the body. The teachers of physical education, coaches, sports persons and students of physical education must be aware of the effect of physical exercise on various systems to realize the qualitative changes in the body for better performance.

The whole body according to functions is divided into nine parts: (i) Skeleton system (ii) Muscular system (iii) Circulatory system (iv) Digestive system (v) Respiratory system (vi) Nervous system (vii) Glandular system (viii) excretory system (ix) Reproductive system.

### A. MUSCULAR SYSTEM

The muscles come after bones in human body. The body's activity is because of muscles. The bones are covered by muscles and bones are active with the help of muscles.

The muscles are covered with skin. It clarifies that muscles are in between bones and skin. Generally muscles are not visible as they covered by skin. Those who take exercises their body is strong their muscles are seen from outside. Every muscle has a group. From where it starts that is called origin. The muscles are of two kinds

1. Voluntary
2. Involuntary
1. **Voluntary Muscles:** They work as we want. They are controlled by brain. Their cells are just like fibers. They are called muscle fibers many muscle fibers are tied with other fibers. They look like lines. Therefore some call them line muscles of hands and feet are in this category. They help in laughing, talking, sleeping and walking activities.
2. **Involuntary Muscles:** These muscles are not under the control of man's wishes. They work of their own according to the needs of the body. They don't have lines upon them as voluntary muscles have. Almost all internal parts of the body like heart, food-pipe, and kidneys abdomen circulatory veins have these involuntary muscles.

#### **Effects of Exercises on Muscular System**

1. The size of muscle fibers increases.
2. Amount of Protein increases.
3. Capillary density per fiber increases.
4. Amount of connective tissue increases.
5. Blood supply in the muscles increases.
6. Myoglobin content increases.
7. Oxidation of carbohydrates and fats increases
8. Number of Mitochondria (Power house of cell) increases.
9. Level of activity of concentration of enzymes and amount of glycogen store increases.
10. ATP-PC and Glycolytic capacity increases.
11. Total and relative body fat decreases.
12. Fat free-weight (muscle mass) increases.
13. Flexibility increases.

#### **B. CIRCULATORY SYSTEM**

The blood goes to every corner of our body. This activity of the blood is called Blood Circulation. The different organs working to circulate the blood are called Blood Circulatory system.

## Organs of Blood Circulation

There are four parts to maintain blood circulation system and they are

1. Heart
2. Arteries
3. Veins
4. Capillaries

**1. Heart:** The most quantity of the blood remains in the heart. It is built of tender flesh. This is the most sensitive and tender part of the body.

**2. Structure of Heart:** Its dimensions are 13cm. long, 9cms wide and 6cms thick. It is placed on Diaphragm between both the lungs. It is a bit tilted on the left side. It is covered with the very thin cover. This part is called pericardium. It has a liquid substance and pericardium save the heart from injuries.

Heart is divided into four parts. Upper half is divided in two parts Right Auricle and Left Auricle and the lower half is divided in two parts Right Ventricle and Left Ventricle.

**Left Auricle:** It has four openings. They all are joint with veins. These veins bring the blood combined with oxygen. This blood comes from lungs.

### Check your progress

Notes : a) Write your answer in the space given below

b) Compare your answer with the those given at the end of the unit

5. What are the two major types of exercise?
6. Bring out any 3 differences between aerobic and anaerobic exercises
7. Tabulate any 5 differences between Yoga and physical exercise

### 6.13 Let us sum up

This unit tries to make you to understand the concept of Yoga and its nature to the human kind. It also briefs out the different types of Asanas .Further it describes about the physical exercise and yoga with its special features in an understandable manner.

**6.14 Unit end activities**

1. Identify the differences between Yoga and Physical exercise
2. Do you think that yoga is essential for the physical organs, if so how ?

**6.15 Answers to check your progress**

1. Refer the notes
2. d
3. Refer the notes
4. a
5. Refer the notes
6. Refer the notes
7. Refer the notes

**6.16 Suggested Readings**

1. Bookwalter, Karl. W, "Physical Education in secondary Schools". The centre for applied
2. Thomas.J.P, "Organization of Physical Education", Gnanodaya Press, Madras, 1972.
3. Bucher Charles. A. "Foundations of Physical Education", 8<sup>th</sup> Rd., the C.V. Mosby Co., St. Louis, 1979.
4. Khurana, S. Suresh, P and Kalsi. R. "Health Education and community Pharamacy", Research in Education, Inc., Newyork, 1962



**UNIT VII**  
**FOOD AND NUTRITION**

**Structure**

**7.1. Introduction**

**7.2. Objectives**

**7.3. Classification of Food**

**7.4. Constituents of food**

**7.5. Vitamins and its deficiency**

**7.6 Nutrition and Mal Nutrition**

**7.7 Balanced diet**

**7.8 Food guide**

**7.9 Diet for Obesity and Under weight**

**7.10 Let us sum up**

**7.11 Unit end activities**

**7.12 Answer to check your progress**

**7.13 Suggested Readings**

## 7.1 Introduction

Food is a substance which produces heat and energy in the body and repairs tissues. It also contains some rough-age which adds quantity or bulk to our diet.

1. Food builds up new tissues.
2. Food repairs the worn out tissues
3. Food produces heat and energy in our body
4. Food supplies material for growth and nourishment to all the parts of body
5. Food helps in the production of compounds that regulate body processes.
6. In short food is very important for life.

## 7.2 Objectives

After learning this unit, you will be able to:

- Describe the meaning, classification and constituents of food
- State the functions of constituents of food
- Know the concept of deficiency of food constituents
- Understand the Meaning of Nutrition and malnutrition
- Identify the balanced diet and Nutritional deficiency diseases

## 7.3 Classification of food

Food serves to nourish, to build up tissues, and to supply energy to the body. Food may be classified in the following ways;

### **According to the source**

1. Food obtained from plant sources
2. Food obtained from animal sources.

### **According to chemical composition**

1. Protein
2. Carbohydrate
3. Fats

4. Vitamins
5. Minerals

#### **According to main function**

1. Body building foods
2. Energy giving foods
3. Protective foods

#### **According to nutritive value**

1. Cereals
2. Pulses
3. Vegetables
4. Nuts and oil seeds
5. Fruits
6. Animal foods
7. Sugar and jiggery
8. Condiments and spices.

#### **Food obtained from vegetables**

- Vegetables foods contain a large purporting of carbohydrates and almost all are proteins, fats and vitamins. These foods are i) cereals, ii)pusses, iii)roots and tubers, iv) green vegetables, v)fruits, vi)nuts, and vii)fungi.
- Cereals are in the form of grains such as wheat, rice, maize they have a high nutritive values.
- Pulses include peace, beans. They are a rich sources of protein. They obtain vitamin A, B and C when fresh. They also have sugar and minerals but little starch
- Roots and tubers include beetroot, carrot, radish, turnip, arrow root, topical and sweet potato. They contain a high percentage of starch and proteins but no fats.
- Green vegetables consist of buds, leaves, leaf-stalk or the whole plant. They contain a high percentage of water and some protein, starch and fats. They are also rich in vitamins A,B,C,E and K

- Fruits are rich in sugar, salts, acids and vitamins.
- Nuts possess a high percentage of proteins and fats but less carbohydrates. They are also rich in vitamin B.
- Fungi are the mushrooms which contain over 90% of water and little protein. They have no food value.

**Food obtained from animals:**

- These foods include: i) Meat, ii) fish, iii) egg, iv) milk.
- Meat usually means mutton or pork. It is rich in protein, iron and some vitamins of B group.
- Fish consists mainly of protein, fat and water. The fat content amount varies widely in different kinds of fish
- Eggs have a high nutritive value. They are rich in iron. Phosphorous and vitamins A and D.
- Milk is obtained from the cow, buffalo, goat and reindeer. Milk contains all the nutrients. It is generally given to babies and children as complete food. Milk is rich in proteins, minerals and vitamins A and B milk products like cream, butter, curd, cheese and ghee are also rich sources of energy.

**Check your progress**

Notes : a) Write your answer in the space given below

b) Compare your answer with the those given at the end of the unit

1. Classify the food based on its sources.
2. Classify the food based on its chemical composition.
3. Food obtained from animals is

a) Meat b) Fish c) Egg d) All the above

( )

## 7.4 Constituents of food

### Chemical composition:

The following are the constituents of food.

1. Protein
2. Carbohydrate
3. Fats
4. Vitamins
5. Minerals

### 1) PROTEINS

The most essential element in our food is protein. This is a mixture of carbon, nitrogen, hydrogen, oxygen, sulphur and phosphorus. The amount of nitrogen in protein is about 1/6 part.

Sources

1. **Vegetables proteins:** e.g. Beans, soybeans, cashewnut, barely, wheat, arhar, groundnut, gram, sesamum, bitter gourd, cabbage, etc,

**Animal protein:** the first grade protein is found in milk, egg, cheese meat, fish etc.

### Uses of protein

1. Builds up tissues in the body.
2. Serves as sources of fat in the body when it excess.
3. Produce heat in the body.
4. Repair the worn out tissues of body. It increases hemoglobin.
5. It is helpful in the growth of energy and working ability.
6. It is helpful in the development of mental faculty

The deficiency of proteins causes the following harms:

1. It increases the ability to intake oxygen.
2. Swelling occurs in legs and stomach.
3. Body development is hindered.
4. Children suffer from rickets.

### 2) CARBOHYDRATES

It is also called sugar. It is the mixture of carbohydrates carbon with hydrogen and oxygen. The preparation in which they are mixed in water, they are mixed in H<sub>2</sub>O carbs in the same proportion

## Sources

### 1. Sugars:

Simple sugar	-	fruit sugar or fructose, grape sugar, or glucose
Complex sugar	-	beet sugar, mannose
Cane sugar	-	sucrose
Malt sugar	-	maltose,
Milk sugar	-	lactose

### 2. Starches: eg.

Cereal	-	barley maize, rice, wheat
Root vegetables	-	arrow root, tapica, turnip
Stem vegetables	-	colossi, potato, and yam.

## Uses

1. Supply energy to the body quickly
2. Produces heat in the body
3. Carbohydrates change into glucose by digestion activity and after absorption, they are carried to muscles, by the blood, where they are used.
4. After this, it changes into glycogen and stores in liver and muscles.
5. When heat or energy is needed, glycogen can be used by bringing it back to sugar.
6. It makes up for the weakness as produced by physical work.

### Deficiency of carbohydrate causes the following harms;

1. The body becomes weak due to its deficiency
2. Activeness of the body decreases
3. The skin starts to shrank
4. The individual proceeds towards old age.
5. A person's daily diet should contain 300gm of sugar & starch.

## 3) FATS

Like carbohydrates, fats too are made from three elements – the mixture of carbon, hydrogen and oxygen, but their proportion varies, fats contain fatty acids and glycerin.

## Sources

Fats may be obtained from two sources

Vegetables - ground ant nut, mustard oil, coconut oil etc.

Animals - eggs, ghee, butter, fish milk, meat, etc.

#### **Uses of fat**

1. Prevents loss of energy from the body
2. Supply more energy to the body as compared with other food.
3. The body looks strong and glowing
4. The internal bones, joints and tissues remain safe.

#### **Deficiency of fats causes the following harms:**

1. The body becomes weak.
2. The weight decreases
3. The skin dries up
4. A normal person needs 100 gm of fats everyday
5. It may cause a stone
6. It may cause heart ailments

#### **4) MINERALS**

Minerals are much needed for the body. The food we eat contains different types of minerals. Mostly minerals are found in fresh fruit and green vegetables. Their amount decreases in cooking.

#### **Uses**

1. They enhance digestive power
2. They make up the deficiency of fibers.
3. They assist in normal growth of the body
4. They maintain the balance of acid chemical
5. They are important for the constitution and health of the body
6. The description of chief minerals is follows.

**1. Calcium:** it is called lime in common dialect

**Sources:** it is found in sufficient amount, in milk, cheese, egg, green vegetables, reddish, pomegranate, orange, carrot, lemon, fresh, fruit and guava, small fish and nuts.

### Uses

- a) It constructs teeth and keeps the muscles active in order to keep them strong.
- b) It controls the heart rate
- c) It strengthens the bones
- d) It protects from asthma and skin diseases
- e) It begets energy to the blood

**2. Iron:** it is a very essential element for a healthy body. It produces hemoglobin fro rted blood cells.

**Sources:** it is found in egg, spinach, green vegetables, banana, dates, mustard, sesame, wheat, pulses, apple, neem, pudina, dry beans, sago, cashew nut, turnip, guava and green dhanian, etc

### Uses

- a) It protects new blood
- b) It enhance appetite
- c) It protects the skin
- d) It saves from breath lessens
- e) It does way fatigue and lethargy
- f) It is useful for girls during adolescence
- g) It is essential for pregnant women

### 3) Iodine

Iodine is helpful in the development of thyroid glands. Ts deficiency causes thyroid aliments and the thyroid gland swells.

**Sources:** it is found in sufficient amount in garlic, onion, tomato, spinach, apple, banana. Seawater, sea fish, sea salt, coastal vegetables, etc.,

4) Phosphorus: it is very helpful in the growth of bones teeth and hair. It helps the nervous system health fully. Its deficiency stops the physical growth.

**Sources:** it is got from milk, curd cheese, egg fish, liver meat, apple, spinach, wheat, green vegetables and black pepper

### 5) Potassium:

It is generally found in all types of food articles, but it is found in more quantity in things hang protein.



**Sources:** it is found in pulses, green vegetables, lemon, dried plum, pear, etc

**Uses**

- a) It strengthens the liver and heart
- b) It removes constipation
- c) It makes tissues flexible
- d) It heals wounds sooner.

**Deficiency of potassium causes the following harms**

- a) It causes fickleness
- b) It causes less of sleep
- c) The heart rate becomes slower
- d) The heart muscles become weaker

**6) Sodium:** this is helpful in preventing kidney and stomach ailments

**Sources:** It is found in sea salt, stone salt, milk, pulses, egg, meat, green vegetables, coconut, reddish, carrot, turnip, etc.

**7) Magnesium:** it keeps all body systems healthy. It protects the body from skin ailments. It also saves from veins related ailment.

**Sources:** it is mostly found in wheat, goat milk and orange.

**8) Copper:** it provides hemoglobin to the blood. It provides oxygen to red blood cells

**Sources:** it is found in pulses tomato, carrot, cabbage dates, choker (husk) spinach, dry fruits,

**9) Chlorine:** chlorine produces digestive juice and it does the task of excreting polluted matters from the body.

**Silicon:** it provides flexibility to fibers and glow to eyes

**Sources:** it is found in tomato and spinach

**11. Common salt:** it is called by the name of sodium chloride too. It makes food tasty and digestive. It diminishes activity in the body. It excretes extra water from the body and thus makes the body activities.

**Sources:** it is found in milk, meat and vegetables.

**12) Sulphur:** it is found in all protein matters. It keeps body fibers healthy. It keeps growth in nails and hair. Its deficiency causes digestive power.

**Sources:** it is found in carrot, cabbage, onion and milk.

## 5) WATER

Our body constitutes 75% of water and 25% of proteins, carbohydrates, fats, vitamins and minerals. Water is essential for our body.

**Element:** hydrogen (two parts) and oxygen (one part)

**Sources:** rain, lakes, tanks, springs, wells, rivers and sea are the sources of water, rain water is the purest form of water and sea water is the dirtiest form of water certain foods like cucumber, green leaf vegetables, milk, water melon contain a high percentage of water.

### Functions of water

1. Needed for all tissues of the body
2. Needed for every chemical process.
3. It maintains the temperature of the body
4. It helps to absorb food
5. Mixing with blood it supplies food and oxygen to all fibers of the body.
6. The blood and all juices of the body look liquid due to water
7. It mixes body toxins into waste, urine and sweat and excretes it out of the body
8. It keeps the body fibers soft and flexible.

### Check your progress

Notes : a) Write your answer in the space given below

b) Compare your answer with those given at the end of the unit

4. Vegetable proteins are taken from ...

a) Soya beans    b) Cashew nut    c) barely    d) All the above  
(    )

5. Animal proteins are taken from

a) Milk    b) Cheese    c) Meat    d) All the above    (    )

6. Example of complex sugar is

a) beet sugar    b) Malt sugar    c) Lactose    d) Maltose    (    )

## **7.5 Vitamins and its deficiency**

There are two types

1. Fat soluble s – A,D,E and K
2. Water soluble in – B and C

### **1. soluble in fats**

#### **Vitamin A (anti infective vitamin)**

Vitamin A is soluble in fat

#### **Sources:**

Vitamin A is found in fish liver oil, pudina, dahlia, pan, cholai, milk, butter, egg, carrot, sweet potato, ripe tomato, spinach, gram peels, ripe mango, ripe papaya, cabbage, etc.

#### **Uses**

1. Helps in digestion and increase appetite
2. Keeps up general bodily health
3. It is essential for body growth
4. It s very essential for body growth
5. It is very essential fern children and pregnant woman
6. It prevents infectious diseases.
7. It keeps the eyes healthy
8. It supplies food to eyes, intestines, lungs, skin and soft fibers.

#### **Deficiency diseases:**

1. It causes eye ailments
2. It causes deafness
3. It causes intestinal ailments
4. It causes deficiency of blood in the body
5. It causes swelling in the body
6. It stops watering in nose, ears, mouth and kidney
7. It causes cough and cold

## **Vitamin D**

### **Sources:**

It is got from direct sunlight, milk, butter, egg yellow, ghee, fish noil and cream etc.,

### **Uses**

1. It is helpful in constructing bones
2. It strengthens bones
3. It is essential for pregnant and feeding mothers
4. It is helpful for strong teeth
5. It can be accumulated in body fibers

### **Its deficiency can have the following effect on the body;**

1. It causes bone diseases in children
2. Teeth do not erupt on proper time in children.
3. It can cause bones to weaken and curve
4. It can cause arthritis and rickets
5. It can cause pain in waist and thighs
6. It can curve the spine and cause hump

## **Vitamin E**

### **(Anti sterility vitamin)**

This vitamin is very important for reproduction. In the male if the vitamins is lacking, few sperms are developed. It also given to women who cannot carry to full term.

### **Sources:**

- It is available in animals as well as in vegetables
- It is found in wheat, carrot, spinach, peanut, milk, butter, cabbage, potato, seed, egg, meat, green, vegetables etc.

### **Uses**

1. It is helpful in body growth
2. It increases weight
3. It prevents miscarriage
4. It prevents loose motions

**Its deficiency can cause the following effect**

1. The male becomes unable to copulate
2. The females suffer miscarriage
3. The child in womb can suffer death.
4. The females become enable to reproduce

**Vitamin – k**  
**(Meno-dion or coagulation vitamin)**

The vitamin is discovered in 1964.

**Sources:**this vitamin is available from spinach, cabbage, cauliflower, soya beans, oil, tomato carrot , egg yellow and orange peel.

**Uses:**

1. It avoids the clotting of blood
2. It is needed for normal coagulation of blood
3. It is essential for m others,
4. It is essential for pregnant women

**Its deficiency can cause harms**

1. The power to coagulate the blood decrease
2. Bleeding is serve in case of an injury
3. Its deficiency causes cessation of production of prothrombin.

**2. Soluble in water**

**Vitamin B**

Vitamin b is very beneficial to the body. It is often types. Vitamin B1, B2 and B12 are very important. The mixture of this vitamin is called vitamin B complex.

## **Vitamin B1 thiamine**

### **Sources:**

Beans, peas, germinating seeds, green vegetable, egg yolk, rice, yeast, wheat, fish, meat, spinach.

### **Uses**

1. Needed by the nerves, appetite and digestion.
2. Helps in using up the carbohydrates stored in the body
3. It is essential for virus-destruction ability of the white blood cells.
4. It is necessary for communication of sensation and natural activity of the intestines.
5. It changes food into energy
6. It prevents beriberi

### **Deficiency**

1. It decreases appetite
2. It causes headache
3. It causes pain to hands, feet and other body parts.
4. It causes darkness before the eyes.
5. It diminishes memory
6. It causes vertigo
7. It causes anxiety and fear.
8. It diminishes the desire to work hard and to stimulating tasks.

## **Vitamin B2**

**(or Riboflavin)**

### **Sources:**

It is found in milk, cheese, yeast, fish, egg white, liver, kidney, meat, green vegetables, etc.

### **Uses**

1. It assists in maintaining the amount of air balanced in the body
2. It maintains youthfulness

3. It protects the body from plague and skin diseases
4. It gets destroyed in sunlight

**Its deficiency causes the following effect**

1. The rate of growth of body becomes slow.
2. Eyes become red
3. Eyesight becomes weak.
4. The tongue becomes reddish.
5. It causes burning sensation to the tongue while eating.

**Vitamin B12  
(Or niacin)**

**Sources:**

It is found in milk, grains, leafy vegetables, eggs, liver, kidney and yeast etc.

**1. Uses**

2. It is essential for tissues and fibres and the metabolism and transportation of hydrogen
3. Niacin is needed for structure of enzymes structures and actions.

**Its deficiency can cause the following effect**

1. Its deficiency causes an ailment called pellagra
2. It causes the skin to become wrinkled and thin
3. It causes swelling on the tongue
4. It causes swelling in gums
5. It causes loose motions continuously
6. It causes headache and lethargy
7. It causes hands and legs to tremble
8. It can cause mental insanity

## Vitamin c

### Sources:

It is found in orange, lemon, grapes, apple, tomato, potato, sour fruits, green vegetables, sprouted grains, etc

### Uses

1. It strengthens the bones
2. It strengthens teeth and gums of children
3. It heals wound soon
4. It increases red blood cells
5. It purifies blood
6. It kills infectious viruses, such as joint pain and cold.

### Its deficiency causes the following effect:

1. It causes scurvy
2. It causes swelling of gums
3. It causes weakness in the body
4. It causes deficiency of blood into the body
5. It causes arthritis
6. It causes tuberculosis

If food is cooked in an open pot for a long time, then its effect is destroyed. It gets destroyed by heat. In cooking green vegetables, if sweet is then vitamin c gets destroyed.

**Check your progress**



Notes : a)Write your answer in the space given below  
b)Compare your answer with the those given at the end of the unit

1.Vitamin-E is useful for ...  
a)Body growth b)Increases weight c)Prevents miscarriages d )All the above  
( )

2.The sources of Vitamin B12 is  
a) Milk b)Cheese c)Lever d )All the above ( )

3.Deficiency of vitamin C causes  
a)Scurvy b )Arthritis c)Tuberglosis d) All the above ( )

## 7.6 Nutrition and Mal Nutrition

### Meaning of Nutrition

Nutrition is defined as the science of food and its relationship to health. It is concerned chiefly with the part played by nutrients in growth and development of the body

In other words Nutrition is the science deals with foods and its uses by the body

Good nutrition stands for the supply of essential nutrients adequate quantities

### Functions of Nutritious food

1. It creates tissues
2. It repairs the damaged tissues
3. It effects chemical change in the body
4. It created heat in the body
5. It provides energy to the body
6. It creates a fiber while the other gets destroyed

7. It accumulate energy in the body

## **Malnutrition**

### **Meaning**

The weak condition of the body when it does not complete and balanced food at the proper time is called malnutrition

### **Causes of Malnutrition**

1. Bad and unhealthy environment
2. Lack of rest and sleep
3. Lack of nutrition's food because of carelessness of elders
4. Indigestion due to indigestible foods
5. No balanced diet
6. Irregular life no time for anything e.g not taking meals at the proper time
7. Chronic long standing diseases
8. Too much work and lack of rest
9. No opportunities for play
10. Lack of self control
11. Domestic reasons e.g. poor economic condition but having a large number of mouths to feed

### **Symptoms of Malnutrition**

1. There is decrease in the amount of flesh and loss of weight
2. The muscles becomes loose
3. The complexion becomes pale

4. The person feels fatigued easily
5. The person is over powered by lassitude
6. The person falls a quick prey to diseases He suffers from headache bad cold and cough
7. The person is bothered by worry restlessness and excitement
8. His muscles and nerves are in a state of tension because he feels bored
9. The person is afraid and becomes suspicious over trifles
10. He cannot concentrate because his mind wavers
11. Teeth weaken and start failing
12. Eyes become sore and eyesight suffers
13. The person does not sleep properly and sees dreams
14. The person adopts bad sitting posture which increases his illness
15. His proper development does not takes place

### **Remedies for malnutrition**

1. Diet: Always take balanced diet (i.e. diet containing all proximal principles) and mixed diet. Take variety of foods Food should be easily digestible but nutritious.
2. Testy and delicious dishes: Food should be testy and delicious. It should appeal to our senses. The food having taste contrary to our like causes more harm than gain
3. Punctuality: we should take our meals punctually
4. Medical Examination and diagnosis: The diseases should be nipped in the bud after being properly diagnosed in medical examination
5. Neatness of Environment: Home environment should be neat and clean the kitchen and dining room should be specially attended to

6. Rules of personal Hygiene: and Health Adequate stress should be laid on rules of personal hygiene and health

7. Proper and regular exercise: The body should be made ever easy and active through suitable and regular exercises

8. Balanced life; Life should have sufficiently challenging work punctuated with intervals of rest and sleep. Work alone or rest alone is injurious. How wisely it has been said:

All work and no play make jack a dull boy

What is this life if full of care we have no time to stand and stare

9. Recreation: These should be adequate provision for recreation

#### **D. Digestive System**

The digestive system works in such a way that the digested food may reach to every part of the body. This job is done by large and small intestine. The minor portion of large intestine is covered by mucous membrane. In between them there are some projected portions. Their shape is just like silk furs. This all fur is filled with blood veins Lymphatic and nerves.

Here much of sugar is consumed by capillaries and milk and fat is consumed by lacteals. The unnecessary sugar, carbo hydrate and protein, which our body does not need through capillaries stored liver and when the body is in need of it is supplied by bile duct as glycogen

Lacteals enter into lymphatic vessel and there they mix up with thorotic duct. From thorotic duct they go to large intestine. In this way the large portion of food go to our body through small intestine. The rest of the matter, which is not needed by our body excretes as excreted matter.

## **Effects of exercise of Digestive system**

When we are busy in doing exercise then those parts which are busy in exercise more blood. The large and small intestines blood reserve is supplied to these parts while doing exercise. With this digestive system is affected.

Therefore it is necessary that one should not go for exercise after taking for about two to three hours. The food takes about three hours to cross the intestines. Therefore it is advised that the exercise should be taken after three hours of food. If one does not follow this rule then undigested food creates some trouble.

If we are regular in exercise then some permanent effects are on our digestive system.

1. Improvement in digestive system: As we have noted that the exercises improve our blood circulation and muscular system in the same way it also improves our digestive systems because all of them are inter related In this way when other system of the body are improved then the digestive system also improves.
2. Increase in appetite: When digestive system is improved then automatically the appetite will also be increased
3. No Constipation: The man, who takes regular exercises never complains of constipation. The intestines are massaged by exercises and excretory function becomes normal.
4. End of elements causing defects intestine: By exercises the elements which are harmful for intestines die themselves and therefore the digestion becomes alright.
5. Increase in the storage capacity of Essential elements in the body: The salivary glands become more active by exercises and with this the digestion is easier and cleaner. Therefore the body is able to store more essential elements in the body and they are supplied when they are needed.
6. Increase in the working cavity of slavery glands. The exercises also increase the working capacity of salivary glands and saliva helps indigestion. Therefore the whole system is affect

- Increase in the energy and capacity of Salivary Glands. The strength of stomach liver and pancreas is improved and they work more efficiently and keep the body free from ailments and disorders.)

## 7.6 Balanced diet

### Definition

A balanced diet is a food which contains sufficient quantity of carbohydrates, proteins, fats vitamins and minerals which provides enough energy and maintains good health. A balanced diet prevents diseases arising out of malnutrition.

### Characteristics of a balanced diet

- The food articles containing proteins and minerals are contained in the diet in adequate amount.
- The materials providing energy are present in the diet in adequate amount
- Presence of preventive nutrients is necessary in a balanced diet.
- This varies with age of each individual
- This varies according to sex of each individual
- This varies according to the climate of the place
- This varies according to the occupation of each individual

### Composition of balanced diet

Every day, balanced diet is essential for all the human beings. A well balanced diet contains the followings.

Composition of Balanced Diet	Required quantity per day
Cereals	400gms
Pulses	85gms
Fats and Oils	56gms
Milk	284gms
Leafy vegetables	114gms
Non leafy vegetables	85gms
Roots	85gms
Fruits	85gms
Sugar Jaggery and honey	57gms
Fish, meat and eggs on alternate days	125gms
Groundnut, salt and condiment	57gms

1. **Cereals:** it includes rice, wheat, barley, oats, and millets. It provides about 50-80 percent of calories need.
2. **Pluses:** it includes dhal, pea beans etc, it contains proteins, iron and vitamins.
3. **Fats and oil:** animal fat includes ghee and butter. It contains high amount of cholesterol. Vegetable fat includes ground nut oil, gingili oil, coconut oil palm oil which contains cholesterol, amino acids and vitamin E.
4. **Milk:** it is ideal food for all ages. It contains all nutrients such as carbohydrates, proteins, fats, vitamins and minerals.
5. **Green leafy vegetables:** it includes drum stick, spinach, and cabbage. These green leaves contain vitamins and minerals.
6. **Roots and tubers:** this category includes potato, tapioca, carrot, radish, onion etc. They contain high amount of starch.
7. **Fruits:** fruits are protective foods. Containing mostly vitamins, minerals, carbohydrates, vitamin etc.
8. **Fish, meat and eggs:** these include flesh of cattle, sheep, goat and pigs. Which have contain high amount of proteins, amino acids, minerals, vitamins and fats..
9. **Sugar, jiggery and honey:** these containing glucose, fructose, iron, carbohydrate, vitamin c etc.
10. **Minerals:** almost all minerals such as sodium, potassium, calcium, phosphorous, magnesium cobalt, iodine, iron.

### Balanced Diet for a common Individual

Proteins	73gms
Fats	74gms
Carbohydrates	408gm
Calcium	2.02gm
Iron	30-40mg
Phosphorus	1.47gm
Vitamin A	40or more mg
Vitamin B	49 or more mg
Vitamin C	3-50mg

The number of calories needed by an individual is discussed for different age group

S.No	Categories	Age group	Requirement of calories
1.	Children	1-6years	1100-1400
		7-12 years	1500-2000
2.	Adolescents	13-16 years	2300-2400
		17-20years	2500-3000
3.	Men	Hard work	3500
		Medium work	3000
		Light work	2400
4.	Women	Hard work	3000
		Feeding mother	2700
		Pregnant	2400
		Medium work	2400
		Light work	2100

### 7.7 Causes of obesity

Eating habits: Certain type of eating habits may led to obesity

- Nibbling between meals is common among housewives and is a potential cause for obesity.
- Some may eat faster talking less time for chewing therefore they tend to consume more food.
- Obese respond to external cues to eat rather than internal hunger signals. They eat when it is mealtime or when they are surrounded by tasty foods instead when they are hungry.
- Housewives who are fond of cooking variety of foods or persons who are working in the business executives who frequently attend business lunch have more chance of becoming obesity.
- Housewives who did not want leftover foods to be thrown out may consume forcibly and put on weight.
- People who eat outside home more frequently are prone to obesity
- People who eat more junk food(high fat, high carbohydrate) may become obese.
- Certain cultural practices like making and distributing sweets on festive occasions contribute to increased calorie consumption.
- Non inclusion of fruits and vegetables as on vegetarian diet leads to weight gain.



- People who like eat processed concentrated and high fat food are susceptible to obesity.
- Some may eat more food when they are unhappy as a compensation mechanism.
- There is an abundance of palatable. Calorically dense food available in the market. Sophisticated marketing in the mass media, super markets and restaurants and large portions of food served outside the home promote high calorie consumption.

### **Obesity problems**

- Obese children may experience delayed puberty.
- Obese teenage girls may be predisposed to certain type of cancer. Cancers are also related with over eating excessive consumption of alcohol and high fat diets.
- Obesity creates complications for pregnancy; duration of labour period is significantly increased for heavy women.
- The overweight people are accident prone.
- Orthopaedic problems are more common among these people
- The obese persons cannot enjoy recreational activities because of their low muscular endurance and poor motor ability.

### **7.7 Food guide**

Low calorie, normal protein vitamin and mineral (except sodium) restricted carbohydrate; restricted fat and liberal fluid, high fibre are given in such cases.

#### **Energy:**

About 20 kcal per kg ideal body weight is prescribed for a sedentary worker and 25 kcal for moderately active worker

#### **Proteins:**

About 0.81g or protein/kg body weight is prescribed for tissue repair and for specific dynamic action.

**Carbohydrates:**

High carbohydrate content foods like potatoes and rice are restricted. Sugar which gives empty calories should be totally avoided. Fruits rich in carbohydrate like banana should be avoided.

**Fat:**

Low fat or no fat diet should be given as calories are reduced. Food rich in fat like nuts and oil seeds avoided. Skim milk should be choice.

**Vitamins:**

With prolonged restriction of fats there is likely to be a restrictions of fat soluble vitamins A and D which may be supplemented

**Minerals:**

Restriction of sodium a common salt is helpful in weight reducing diet as excess sodium predisposes to retention of fluid. Research suggests that a calcium rich diet especially one that included diary sources(with limit in total calories) not only helps young women keep weight in check but may reduce overall levels of body fat. Calcium may depress certain hormones which consequently improve the body's ability to break down fat in cells and slow fat production.

**Fluid:**

Fluids can be taken liberally as extra fluids are excreted by healthy kidneys. Also a glass of water before meals helps to out down food intake

**High fibre:**

High fibre low calorie foods like green leafy vegetables, fruits, vegetables SALADS, WHOLE GRAINCEREALS AND PULSES CAN BE included in the diet, inclusion of high fibre foods in diets many advantages, they are 1. Low in calorie density, 2. Foods like green provide vitamins and minerals (which are difficult to meet with restricted food) 3. Give satiety 4. Help in regulating bowel movements 5. Reduce blood cholesterol 6. Promote chewing and decreases rate if ingestion. Higher intake of fibre automatically cut down fat and calories. British nutrition

foundation (1990) has established the effectiveness of dietary fibre intake in achieving significant reduction in body weights without any side effects.

### **Diet tips**

- Take control of what you eat
- Eat frequently and eat slowly
- Eat more fruits, vegetables and grains
- Eat more fibres
- Cut down on sugar
- Too much of a bad thing
- Too little of a good thing

### **Suggested recipes**

Foods		Reason
Vegetable salads	-	low calorie and high fibre
Chapathis without oil	-	more proteins and high fibre and give satiety
Thin dats, steamed foods		
Like idlis	-	to limit calories, increase protein content
Thin soups	-	provide fluids, low calorie value, provide fullness
Poached fish	-	low in calories high in protein of good quality
Boiled chowli	-	rich in protein and B vitamins
Green porial	-	high in fibre
Coffee, tea without		
Sugar	-	low calories

## **2. UNDER WEIGHT**

Half the Indian rural population is underweight with up to three quarters being so classified in deprived communities.

A very large population of rural Indian households have inadequate food supplied. Chronic energy deficiency is due to chronic food deficiency

**People whose BMI is less than 18.5 are considered as under weight**

### **Limitation of under weight**

- Adults with BI < 18.5 have reduced VO max, reduced capacity for sustained heavy work and a low productivity.
- Pregnant women show a propositional increase in though risk of an underweight busy born in relation to post par turn BMIs and BMIs range from 25 to 16 or less.
- Progressively greater proportions of time are spend off work or in bed ill when BMI levels are below 17 in men and women
- There is a progressive curvilinear increase in mortality in group of men with BMIs ranging from 18.5 to below 16.0
- Immunological deficits are seen particularly in men with low BMIs concomitant micro nutrient deficiencies are present
- Undernourished children have lower heights and weights
- The age of menarche is delayed in undernourished girls by about 1-2 years.

### **DIETAY MODIFICATIONS**

A high calorie, Hugh fat diet with liberal vitamin intake is recommended. But before going into the diet the first step is to determine and eliminate the causes for under eating. Then a balanced diet should be planned based on the requirements.

#### **Energy:**

The calorie requirements vary depending upon the activities, for increasing weight the total calorie intake should in excess of the energy requirement. An additional 500 kcals per day in recommended. The increase should be gradual over one or two weeks otherwise digestive disturbances may occur.

**Proteins:**

Instead of 1g of protein, over 1.2 g per kg is recommended for tissue building. Good quality protein is completely utilized by the body and as far possible best protein sources must be liberally included in the initial stage.

**Fats:**

Even though fat content is increased easily digestible fats are to be included. Fried and fatty foods are not recommended as they may cause diarrhoea. Fatty food should not be taken at the beginning of a meal as they reduce appetite. High calorie fatty foods such as cream, butter, margarine and oils help to increase the weight.

**Carbohydrate:**

High carbohydrate sources must form the basis of the diet. Leafy vegetables should be restricted and preference to be given to potato and yam. Dried fruit, sweets, nuts, desserts, jam, jelly, cereal products and non-vegetarian foods are rich sources for energy and can be liberally included in the diet. The number of meals should be increased. Two feeds incorporating soups, juices or sweets in between major meals improve the nutritive value of the diet. Easily digestible foods should be given. Porridge, cutlets, desserts, potato chips, chips, high protein drinks like milk, malted milk and badam kheer can be included. Thick soups are easily digestible and high nutritious items.

**Vitamins and minerals:**

With a liberal diet there is no need for extra vitamin and mineral supplement.

**Fluid:**

Fluids should not be taken before or with a meal but only after a meal so that food intake is not reduced. Enough fluids must be taken so as to avoid constipation.

**7.8 Diet for obesity and under weight****1) Medical management**

- Excess weight will be reduced at an early stage of obesity by the medical intervention.
- Regular visit to a doctor is essential to avoid health problems caused by excess weight (eg. High blood pressure, liver problems, diabetes)

## 2) Education

Try to educate the obsessed persons the best ways to eat, stay active and solve problems relating to weight by counselling orientation about diet. For successful weight control regular physical can activities is necessary.

- Avoid eating of high fat foods
- Eat small and frequent meals
- Maintain structures patter of eating
- Decreased consumption of liquids sweetened with sugar
- Engage in physical activities

## 3. Environmental changes

The environmental can have either a negative impact or a positive impact. Overweight children and families can make changes in their environments to reduce triggers for unhealthy eating and promote high levels of activities

## 4. Support groups

The obsessed children can take support from the dietician and physical educationists to undergo physical activities and controlled deistic conditions.

### Check your progress

Notes : a)Write your answer in the space given below

b)Compare your answer with the those given at the end of the unit

1. Mention a few symptoms of Malnutrition.

---

---

2. Could you suggest a diet for obesity

---

---

### **7.10 Let us sum up**

The present unit attempts to make you to understand the basic concept of food and its constituents-classification, deficiency and also it briefs out the value of nutrition and malnutrition and the balanced diet of a normal human being in a detailed manner.

### **7.11 Unit end activities**

1. Classify the food based on their nutritional values
2. Could you list out the principles of managing the diet.

### **7.12 Answer to check your progress**

1. Refer this material
2. Refer this material
- 3.d
- 4.d
- 5.c
- 6.a
- 7.d
- 8.d
- 9.d

**10 Refer this notes**

**12. Refer this notes**

### **7.13 Suggested Reading**

1. Khurana, S. Suresh, P and Kalsi. R. "Health Education and community Pharamacy", Research in Education, Inc., Newyork, 1962.

2. Vikas & Co., Jalaudhan, 1996.
3. Nanda V.K. "Health Education", Anmol Publications Pvt Lts., New Delhi, 1997.
4. Parl. K, "Text book of Preventure and Social Medicine", 7<sup>th</sup> Ed., Banarsidas Bhanot Publishers, Jabalpur, 2003.

## REFERENCES

1. Singh, Ajmer, et.al "Essentials of Physical Education", kalyani publishers, New Delhi, 2003.
2. HiSvendra Chandra, Sothi, Puri Krishnan "Health Education and Physical Education", Surject Publications Delhi, 2005.
3. Show, Dhanajoy and Kaushick Seema, "Lesson planning-Teaching Methods and class Management in Physical Education", Khal Sahitya Kendra, New Delhi, 2007.
4. Dash. B.N (2007), Health and Physical Education, New Delhi, Neelkamal publications
5. Sharma., B.L., & Naresh Pratap (2007) Physical Education, Meerut: R. Lall Book Depot.
6. Bookwalter, Karl. W, "Physical Education in secondary Schools". The centre for applied
7. Thomas.J.P, "Organization of Physical Education", Gnanodaya Press, Madras, 1972.
8. Bucher Charles. A. "Foundations of Physical Education", 8<sup>th</sup> Rd., the C.V. Mosby Co., St. Louis, 1979.
9. Khurana, S. Suresh, P and Kalsi. R. "Health Education and community Pharamacy", Research in Education, Inc., Newyork, 1962.
10. Vikas & Co., Jalaudhan, 1996.
11. Nanda V.K. "Health Education", Anmol Publications Pvt Lts., New Delhi, 1997.
12. Parl. K, "Text book of Preventure and Social Medicine", 7<sup>th</sup> Ed., Banarsidas Bhanot Publishers, Jabalpur, 2003.
13. Singh, Ajmer, et.al "Essentials of Physical Education", kalyani publishers, New Delhi, 2003.
14. Shivendra Chandra, Sothi, Puri Krishnan "Health Education and Physical Education", Surject Publications Delhi, 2005.
15. Show, Dhanajoy and Kaushick Seema, "Lesson planning-Teaching Methods and class Management in Physical Education", Khal Sahitya Kendra, New Delhi, 2007.
16. Dash. B.N (2007), Health and Physical Education, New Delhi, Neelkamal publications
17. Sharma., B.L., & Naresh Pratap (2007) Physical Education, Meerut: R. Lall Book Depot.